

**TC120**

**Thermal Camera**



## 1. Safety warnings

---

National Health and Safety Legislation requires users of this equipment and their employers to carry out valid risk assessments of all work to identify potential sources of danger and risk of injury. Warnings and precautions must be read and understood before an instrument is used. They must be observed during operation of the instrument. The following safety information must be observed to ensure maximum personal safety during the operation of this device. If the equipment is used in a manner not specified by the manufacturer, the protection provided by the equipment may be impaired.

### Handling

- Avoid knocking, throwing or vibrating the device or its accessories to prevent damage.
- Do not disassemble or modify the device. There are no user serviceable parts within.
- Refer all servicing to Megger.
- Do not expose the device to dust or moisture. Fit the lens cover when the device is not in use.
- Do not look into the laser beam or point beam to eyes.

### Storage

- Place the device and all accessories in protective packing box when not in use.

### Temperature:

- Do not use the device at operating temperatures or storage temperature that are outside the allowed range.
- Avoid direct exposure of the device to high-intensity thermal radiation sources such as the sun, lasers, or spot welders.

### Environment:

- Do not expose the device to dusty or a wet environment.

### Substances:

- Liquid Exposure: Do not spill liquids on the device or cables, as this can cause damage.
- The device is powered by a Lithium-ion battery; users must follow battery precautions:
- Charge the battery as specified in the user guide, following the proper steps and precautions. Improper charging may heat or damage the battery, or even cause injuries.

## Device Cleaning:

- Non-optical Surface: Use a clean, soft cloth to wipe non-optical surfaces of the device as needed.
- Optical Surface: Avoid staining the lens and touching it with hands, as sweat can leave traces and corrode the optical coating. When the lens surface is stained, clean it with a special lens-wiping cloth.

## Battery Replacement

- Refer battery servicing and replacement to Megger.

## Temperature

- If the device operates for a long time, especially at high temperatures, the surface may become warm. Stop charging and move the device to a shaded area. Avoid prolonged contact with hot surfaces.

## Charging







- When charging, use the adapter and cables provided by Megger.

## Battery level

- Charging time varies based on temperature and usage.
- The system will prompt you when the battery level is low and automatically shut off when too low.
- If the device does not respond when the power button is pressed, the battery may be depleted. Charge it with the charger provided for at least 10 minutes before attempting to turn it on again.

For Full Safety Warnings see Product User Guide.

### 1.1 Safety symbols marked on the instrument

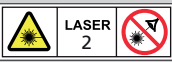
	Refer to user instructions		Equipment complies with current EU directives.
	Equipment protected throughout by Double Insulation		Indoor use only
	Warning: laser beam		Do not dispose of in landfill, sewage systems or by fire.
	Class 2 Laser Product. Do not look into the laser beam or point beam to eyes.		

## 2. Package contents

---

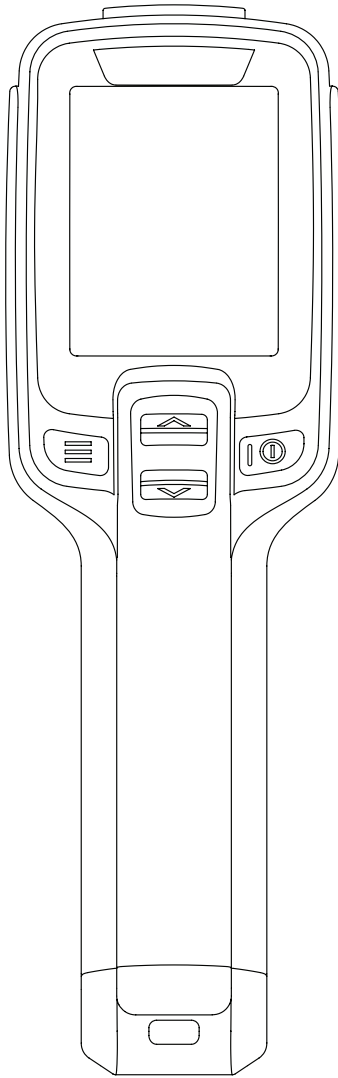

Thermal camera  
(including battery)



Quick Operation Guide

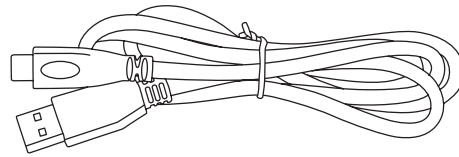

USB data cable

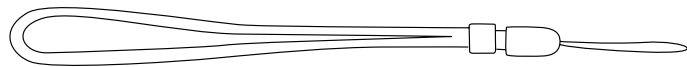

Wristband

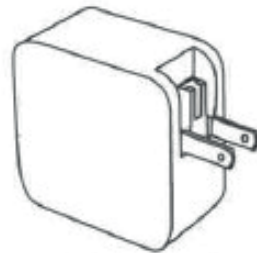

US standard  
adapter plug



EU standard  
adapter plug

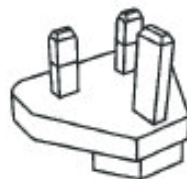

UK standard  
adapter plug

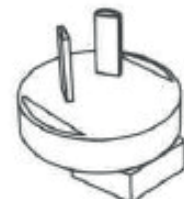

Australian standard  
adapter plug

### 3. Instrument overview

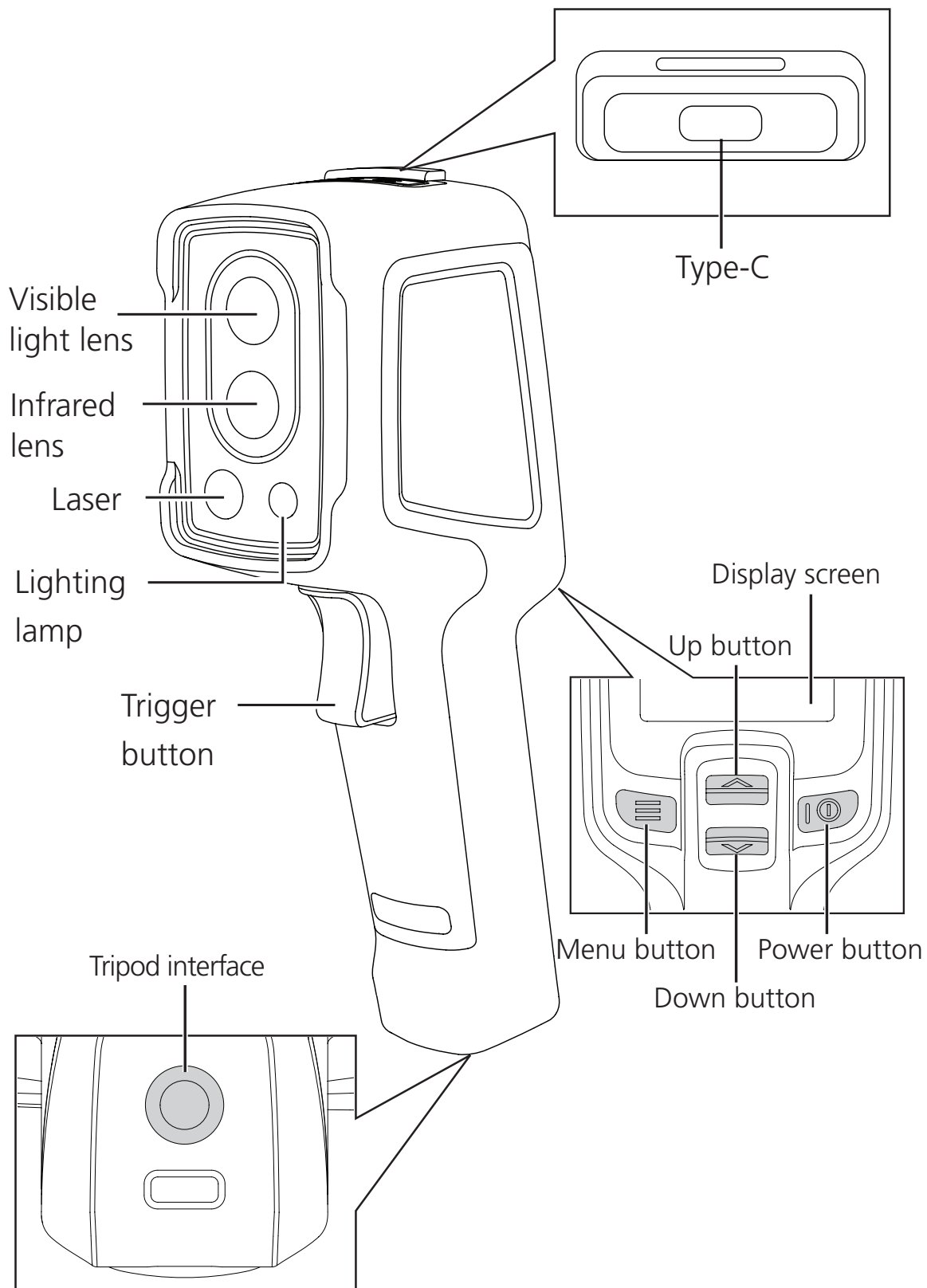

## 4. Basic Operation

---

Please follow the steps below:

### 4.1 Charging

Please use a 5V 1A or 5V 2A power adapter and USB cable to charge the device.

Use the USB cable in the accessories to connect the device to the computer for charging.

When charging, open the protective cover on the top of the device, connect one end of the data cable to the USB Type-C interface of the device, and connect the other end to the adapter or computer.

### 4.2 Power on

Press and hold the power button to power on the device.

### 4.3 Find the target

Align the thermal camera with the object concerned.

### 4.4 Capture the image

Click the trigger button to capture the image.



## Local Sales office

---

Megger Limited

## Manufacturing sites

---

Megger Limited

Megger AB

Megger Valley Forge

Megger USA - Dallas

Megger USA - Fort Collins

Megger GmbH

Megger Germany GmbH

Megger Germany GmbH

This instrument is manufactured in China.

The company reserves the right to change the specification or design without prior notice.

Megger is a registered trademark

The Bluetooth® word mark and logos are registered trademarks owned by Bluetooth SIG, Inc and are used under licence.

TC120\_QSSW\_EN\_V03

Find Quality Products Online at:

 [Valuetesters.com](http://Valuetesters.com)

**Megger**<sup>®</sup>

[info@valuetesters.com](mailto:info@valuetesters.com)