

User Manual
Reference/Professional Temperature Calibrator
Jofra RTC-125/157/158/159/168/187/250/700
A/B/C
Jofra PTC-125/155/350/425/660 A/B/C



User Manual

Reference/ Professional Temperature Calibrator

JOFRA RTC-156/157/158/159/168/187/250/700 A/B/C

JOFRA PTC-125/155/350/425/660 A/B/C

© Copyright 2012 AMETEK Denmark A/S



List of contents

1.0	Introduction	4
1.1	List of equipment received	5
2.0	Safety instructions	6
3.0	Setting up the calibrator	11
3.1	Before use	11
3.1.1	Setting up a dry-block calibrator	13
3.1.2	Setting up a liquid bath calibrator (RTC-158/168/250 only).....	14
3.2	During use	18
3.3	Programming intelligent sensors	18
3.4	Keyboard.....	19
3.5	Main screen display	20
3.6	Standard connections	22
3.7	Input sections (B and C versions only)	23
3.8	Stability of temperature values	24
4.0	Operating the Calibrator	25
4.1	Operating principle.....	25
4.1.1	Horizontal Menu	25
4.1.2	Vertical Menu	26
4.1.3	Parameter Fields.....	26
4.1.4	Working with lists	27
4.5	Starting the calibrator.....	29
4.6	Setting the temperature	29
4.7	Calibration (optional - PTC)	30
4.7.1	Running a calibration	30
4.7.2	Viewing calibration results	33
4.7.3	Displaying calibration information	33
4.7.4	Deleting workorders	35
4.8	Switch test menu	35
4.8.1	Running a switch test.....	35
4.8.2	Showing switch test results.....	36
4.9	Auto step menu.....	38
4.9.1	Running an Auto step calibration	38
4.9.2	Auto Step test results.....	40
4.10	Sensor Setup menu	40
4.10.1	Setting the additional stability time (A version)	41
4.10.2	Setting the parameters for TRUE – reference sensor (B and C versions only).....	41
4.10.3	Setting the parameters for DLC– dynamic load compensation – (RTC, B and C versions only) ..	42
4.10.4	Setting the parameters for SUT– Sensor under test (B versions only)	42
4.10.5	Viewing the Reference and DLC data (B and C versions only).....	44
4.11	Calibrator Setup menu.....	45
4.11.1	Setting the temperature parameters	45
4.11.2	Setting the temperature resolution.....	46
4.11.3	Setting the sound, volume and operating mode	46
4.11.4	Setting recalibration interval.....	47
4.11.5	Changing the date and time.....	47
4.11.6	Choosing a language (optional)	47
4.11.7	Saving a setup	48
4.11.8	Loading a setup	48
4.11.9	Resetting the instrument setup to factory defaults.....	48
4.11.10	Network Configuration (for service use only).....	49
4.12	Selecting the stirrer speed (RTC-158/168/250 only)	49
4.13	Information Screen	50
4.14	About the calibrator.....	50
5.0	Setting the mains voltage and replacing the main fuses.....	51
6.0	After use.....	52
6.1	Storing and transporting the calibrators.....	52
6.1.1	Transporting the dry-block calibrator	54

6.1.2	Transporting the liquid bath calibrator	54
6.2	Emptying the well (liquid baths only)	54

1.0 Introduction

This user manual applies to the following instruments:

Reference Temperature Calibrators

- JOFRA RTC-156 A - Temperature calibrator
- JOFRA RTC-156 B - Temperature calibrator with sensor and reference inputs
- JOFRA RTC-156 C - Temperature calibrator with reference input
- JOFRA RTC-157 A - Temperature calibrator
- JOFRA RTC-157 B - Temperature calibrator with sensor and reference inputs
- JOFRA RTC-157 C - Temperature calibrator with reference input
- JOFRA RTC-158 A - Temperature calibrator
- JOFRA RTC-158 B - Temperature calibrator with sensor and reference inputs
- JOFRA RTC-158 C - Temperature calibrator with reference input
- JOFRA RTC-159 A - Temperature calibrator
- JOFRA RTC-159 B - Temperature calibrator with sensor and reference inputs
- JOFRA RTC-159 C - Temperature calibrator with reference input
- JOFRA RTC-168 A - Temperature calibrator
- JOFRA RTC-168 B - Temperature calibrator with sensor and reference inputs
- JOFRA RTC-168 C - Temperature calibrator with reference input
- JOFRA RTC-187 A - Temperature calibrator
- JOFRA RTC-187 B - Temperature calibrator with sensor and reference inputs
- JOFRA RTC-187 C - Temperature calibrator with reference input
- JOFRA RTC-250 A - Temperature calibrator
- JOFRA RTC-250 B - Temperature calibrator with sensor and reference inputs
- JOFRA RTC-250 C - Temperature calibrator with reference input
- JOFRA RTC-700 A - Temperature calibrator
- JOFRA RTC-700 B - Temperature calibrator with sensor and reference inputs
- JOFRA RTC-700 C - Temperature calibrator with reference input

Professional Temperature Calibrators

- JOFRA PTC-125 A - Temperature calibrator
- JOFRA PTC-125 B - Temperature calibrator with sensor and reference inputs
- JOFRA PTC-125 C - Temperature calibrator with reference input
- JOFRA PTC-155 A - Temperature calibrator
- JOFRA PTC-155 B - Temperature calibrator with sensor and reference inputs
- JOFRA PTC-155 C - Temperature calibrator with reference input
- JOFRA PTC-350 A - Temperature calibrator
- JOFRA PTC-350 B - Temperature calibrator with sensor and reference inputs
- JOFRA PTC-350 C - Temperature calibrator with reference input
- JOFRA PTC-425 A - Temperature calibrator
- JOFRA PTC-425 B - Temperature calibrator with sensor and reference inputs
- JOFRA PTC-425 C - Temperature calibrator with reference input
- JOFRA PTC-660 A - Temperature calibrator
- JOFRA PTC-660 B - Temperature calibrator with sensor and reference inputs
- JOFRA PTC-660 C - Temperature calibrator with reference input

These instruments are temperature calibrators designed to calibrate temperature sensors and thermostats.

The RTC-156/157/159/187/700 A/B/C instruments and the PTC-series are all designed as dry-block calibrators, where as the RTC-158/168/250 A/B/C instruments are designed to be used both as dry-block calibrators and liquid baths.

Read this manual carefully before using the instrument and ensure that all safety instructions and warnings are observed.

1.1 List of equipment received

When you receive the instrument, the following should be enclosed:

- 1 calibrator
- 1 mains cable
- 2 sets of test cables (2 black, 2 red –B versions only)
- 1 USB memory stick containing electronic manuals and software package: JOFRACAL, AMETRIM and CON050
- 1 USB cable
- 1 tool for insertion tube
- 1 traceable certificate (A versions)
- 2 traceable certificates (C versions)
- 3 traceable certificates (B versions)
- 1 set of silicone plugs for insulation plugs (RTC-156/157/158/159/168/187/250 and PTC-125/155 only)
- 1 insulation collar (RTC-156 only)
- 1 protection shield (RTC-700 and PTC-660 only)



Caution

Do not use the RTC-158/168 insulation plug (black POM) with the RTC-250 instrument due to the risk of melting.

Always use the correct - yellow/brown PEEK - insulation plug with the RTC-250 instrument.

- RTC-158/168/250 A/B/C only (liquid bath) – OPTIONAL :
 - 1 liquid bath kit consisting of :
 - 1 sensor basket with temperature equalizer tube
 - 2 lids for transportation / calibration (RTC-158/250)
 - 1 lid for transportation (RTC-168)
 - 1 lid for calibration (RTC-168)
 - 3 stirring magnets
 - 1 stirring magnet remover (RTC-158/250)
 - 1 liquid drainage syringe
 - 1 bottom shield
 - 1 silicone oil
 - 1 oil material safety data sheet

2.0 Safety instructions



Read this manual carefully before using the instrument!

In order to avoid any personal injuries and/or damage to the instrument all safety instructions and warnings must be observed.

The screen menus shown in this manual represent the menus displayed when using a B-version.

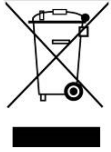

Disposal – WEEE Directive

These calibrators contain Electrical and Electronic circuits and must be recycled or disposed of properly (in accordance with the WEEE Directive 2012/19/EU).



Warning

About the use:

- Always supply the calibrator using a power circuit which is separate from essential safety equipment and vital hospital equipment etc., to prevent fatal consequential damages from a potential electrical failure.
- The calibrator **must not** be used for any purposes other than those described in this manual, as it might cause a hazard.
- The calibrator has been designed for **indoor use only** and is not to be used in wet locations.
- The calibrator is **not to be used in hazardous areas**, where vapour or gas leaks, etc. may constitute a danger of explosion.
- The calibrator is **not** designed for operation in altitudes above 2000 meters.
- The calibrator is a CLASS I product and must be connected to a mains outlet with a protective earth connection. Ensure the ground connection of the calibrator is properly connected to the protective earth before switching on the calibrator. Always use a mains power cable with a mains plug that connects to the protective earth.
- To ensure the connection to protective earth any extension cord used **must** also have a protective earth conductor.
- Only use a mains power cord with a current rating as specified by the calibrator and which is approved for the voltage and plug configuration in your area.
- Before switching on the calibrator make sure that it is set to the voltage of the mains electricity supply.
- **Always** position the calibrator to enable easy and quick disconnection of the power source (mains inlet socket).
- The calibrator **must** be kept free within an area of 20 cm on all sides and 1 metre above the calibrator due to fire hazard.
- After transport or storage in humid conditions or if the calibrator has not been heated up to minimum 100°C within the last 10 days, the instrument needs to be operated with a well temperature of at least 140°C for 2 hours before it can be assumed to meet all safety requirements of EN61010-1 (PTC-350/425/660 and RTC-250/700 only).
- If the calibrator is wet or has been in a wet environment, do not apply power until the moisture has been removed for example by storage at 50°C in a low humidity environment for at least 4 hours.

- **Never** use heat transfer fluids such as silicone, oil, paste, etc. in the dry-block calibrators. These fluids may penetrate the calibrator and cause electrical hazard, damage or create poisonous fumes.
- The calibrator **must** be switched off before any attempt to service the instrument is made. There are no user serviceable parts inside the calibrator.
- When cleaning the well or the insertion tube, **REMEMBER** to wear goggles when using compressed air in the dry-block calibrator and cleaning oil in the liquid bath calibrator.
- Use protection shield when calibrating at high temperatures (RTC-700 and PTC-660)
- The RTC-159 and PTC-125 contains R-1270 and R-704 under pressure. The calibrator must **under no conditions** be stored at ambient temperatures above 50°C (122°F) or operated at ambient temperatures above 40°C (104°F). Doing so may cause a hazard.
- Remember to use appropriate protective equipment or get help when carrying the calibrator (for a longer distance) in order to prevent injuries from dropping the calibrator.

About the front panel:

- For B and C versions only, the sockets on the input module must **NEVER** be connected to voltages exceeding 30V with reference to ground.
- Thermostats must not be connected to any other voltage sources during test.

About insertion tubes, insulation plugs, well and sensor:

- **Never** leave hot insertion tubes which have been removed from the calibrator unsupervised – they may constitute a fire hazard or personal injury.
If you intend to store the calibrator in the optional carrying case after use, you **must** ensure that the instrument has cooled down to a temperature **below 50°C/122°F** before placing it in the carrying case.
- Never place a hot insertion tube in the optional carrying case.
- Use only insulation plugs supplied by AMETEK Denmark A/S.

About the fuses:

- The fuse box must not be removed from the power control switch until the mains cable has been disconnected.
- The two main fuses must have the specified current and voltage rating and be of the specified type. The use of makeshift fuses and the short-circuiting of fuse holders are prohibited and may cause a hazard.

About the liquid bath (RTC-158/168/250 A/B/C only):

- When using liquids in the calibrator, ensure proper ventilation or local extraction to handle vapor and other airborne particles, as recommended for the particular liquid in accordance with the MSDS (Material Safety Data Sheet) of the liquid and in accordance with the local environmental regulations.
- When handling the liquid, ensure to immediately wipe up and handle spillages in accordance with the MSDS (Material Safety Data Sheet) of the liquid and in accordance with the local environmental regulations.
- For liquid bath ensure that the sensor is absolutely clean and dry as a few drops of water in the well (liquid baths) might cause a steam explosion.
- **Do not pour** cold fluid into a hot well – it might cause an explosion.
- AMETEK Denmark A/S **does not** take any responsibility, if the well is filled with other fluids than those recommended.
- Liquid baths should **only** be operated by trained personal.

- Heat transfer fluids must **only** be used in calibrators prepared as a liquid bath. If these fluids are heated above specified temperature they will create noxious or toxic fumes. Proper ventilation must be used.
- To avoid hazards from treating fluids in a wrong manner, **always** reduce the "Max. SET-temperature allowed" in the CALIBRATOR SETUP MENU according to the specifications of the fluid to be used.
If using a calibrator outside of the fluids specifications there is a risk of fire hazards, personal injury or chemical release.
By reducing the "Max. SET-temperature allowed", the calibrator cannot be used outside this temperature range.
Be aware of the flash point, the boiling point and other fluid properties applicable to the usage when setting the Max. SET-temperature. Read the MSDS (Material Safety Data Sheet) of the liquid before use.
- **Always** remove the liquid from the calibrator before transportation.
- Product information on the fluid must be carefully investigated before use.
- **Do not** handle hot fluid.
- If the oil is heated beyond the flash point, it may constitute a fire hazard.
- **Do not pour** water or any other fluids into a bath filled with hot oil, because only a few drops of water might cause a steam explosion, if poured into above 100°C hot oil.
- **Do not** under any circumstances pour water on burning oil. It might cause a dangerous steam explosion.



Caution – Hot surface

This symbol is visible on the grid plate.



- **Do not touch** the grid plate, the well or the insertion tube as the calibrator is heating up – they may be very hot and cause burns.
- **Do not touch** the lid or the spill tray as the calibrator is heating up – they may be very hot and cause burns (RTC-158/168/250 A/B/C only).
- **Do not touch** the tip of the sensor when it is removed from the insertion tube/well – it may be very hot and cause burns.
- **Do not touch** the handle of the calibrator during use – it may be very hot and cause burns.
- **Over 50°C/122°F**
If the calibrator has been heated up to temperatures above 50°C/122°F, you must wait until the instrument reaches a temperature **below 50°C/122°F** before you switch it off.
- **Do not** remove the insert from the calibrator before the insert has cooled down to less than 50°C/122°F.



Caution – Cold surface

Below 0°C/32°F (**applies only to the RTC-156/157/158/159/168/187 A/B/C and PTC-125/155 A/B/C models**)

- **Do not** touch the well or insertion tube when these are below 0°C/32°F - they might create frostbite.
- If the calibrator has reached a temperature below 0°C/32°F, ice crystals may form on the insertion tube and on the well. This, in turn, may cause the material surfaces to oxidize.

To prevent this from happening, the insertion tube and the well must be dried. This is done by heating up the calibrator to min. 100°C/212°F until all water left has evaporated.

Remove the insulation plug while heating up.

It is very important that humidity in the well and insertion tube is removed to prevent corrosion and frost expansion damages.



Caution...

About the use:

- **Do not** use the instrument if the internal fan is out of order.
- Before cleaning the calibrator, you **must** switch it off, allow it to cool down and remove all cables.
- Always place power cable and cables to attached accessories, such as sensors, in a safe way to reduce the risk of tripping.
- When transporting (carrying) the calibrator, be extra careful not to drop it on other materials, equipment, and body parts.
- Ensure that the allowed temperature range of the external sensors is not exceeded by the calibrator's temperature range. See section 4.11.1 to setup the calibrator's allowed temperature range.
- Acoustic noise emitted from the calibrator may contribute to the existing noise environment. Be aware of the total noise exposure and act accordingly to maintain a safe, healthy, and pleasant working environment.

About the liquid bath (RTC-158/168/250 A/B/C only):

- Before use, ensure that all external equipment and accessories in contact with the liquid is suited to this exposure.
- Be careful **not to overfill** the well with liquid.
- Avoid getting silicone oil on the clothes. It is impossible to wash off.
- The silicone oil level rises several centimetres when the temperature is rising. Please read instructions in section 3.1.2 about oil level. To stop overflow switch off the main power or set a low temperature and the oil level will decrease when cooled down.
- In case of liquid spillages into holes, slots or crevices in the calibrator, attempt to wipe up the liquid as soon as possible. If the liquid is electrically conductive or corrosive, immediately power off the calibrator and contact the dealer to send in the calibrator for service.
- Carefully wipe off all silicone oil from the sensor under test to avoid spreading of the silicone oil.
- Be careful to select the right oil for the right task. Using other than the recommended oils might cause damage to the calibrator or degrade the performance.
- Remove excess hot fluid with the outmost care, as it might be very hot.
- **Do not** attempt to remove hot fluid with the liquid drainage tube, as it might melt.

About the well, insertion tube and sensor:

- The well and the insertion tube **must** be clean and dry before use.
- **Do not** pour any form of liquids into the well. It might damage the well or cause a hazard.
- **Do not** use any alkali, acid or ionic fluids in the aluminium well as it might be damaged.

- Scratches and other damage to the insertion tubes should be avoided by storing the insertion tubes carefully when not in use.
- The insertion tube must **never** be forced into the well.
The well could be damaged as a result, and the insertion tube may get stuck.
- **Before** using new insertion tubes for the calibration, the insertion tubes **must** be heated up to maximum temperature – 250°C (482°F) / 700°C (1292°F) (RTC-250/700 A/B/C only) and 350°C (662°F) / 425°C (797°F) / 660°C (1220°F) (PTC-350/660 A/B/C only) - for a period of minimum 30 minutes.
- The insertion tube must **always** be removed from the calibrator after use.
The humidity in the air may cause corrosion oxidation on the insertion tube inside the instrument. There is a risk that the insertion tube may get stuck if this is allowed to happen.
- If the calibrator is to be transported, the insertion tube **must** be removed from the well to avoid damage to the instrument.
- The tip of the sensor should rest at the bottom of the sensor basket for optimum results (liquid baths only).
- Be careful **not to** submerge the handle or wire inlet of the sensor-under-test in the fluid, as this might damage the sensor (liquid baths only).



Note...

The product liability **only** applies if the instrument is subject to a manufacturing defect. This liability becomes void if the user fails to follow the instructions set out in this manual or uses unauthorized spare parts.

3.0 Setting up the calibrator

3.1 Before use

The RTC/PTC-B-versions have a precision reference input. To achieve the high precision, a set of sensor coefficients relating to the specific sensor must be present in the RTC/PTC. Before use of the RTC/PTC, ensure that the correct coefficients in the RTC/PTC are equal to those from the sensors calibration certificate. This is done with the included PC software JOFRACAL. Please read how to do in the chapter "Reference Sensors" in the JOFRACAL user manual.



Warning

- The calibrator **must not** be used for any purposes other than those described in this manual, as it might cause a hazard.
- The calibrator has been designed for **indoor use only** and is not to be used in wet locations.
- The calibrator is **not to be used in hazardous areas**, where vapour or gas leaks, etc. may constitute a danger of explosion.
- The calibrator is **not** designed for operation in altitudes above 2000 meters.
- The calibrator is a CLASS I product and must be connected to a mains outlet with a protective earth connection. Ensure the ground connection of the calibrator is properly connected to the protective earth before switching on the calibrator. Always use a mains power cable with a mains plug that connects to the protective earth.
- To ensure the connection to protective earth any extension cord used **must** also have a protective earth conductor.
- Only use a mains power cord with a current rating as specified by the calibrator and which is approved for the voltage and plug configuration in your area.
- Before switching on the calibrator make sure that it is set to the voltage of the mains electricity supply.
- **Always** position the calibrator to enable easy and quick disconnection of the power source (mains inlet socket).
- The calibrator **must** be kept free within an area of 20 cm on all sides and 1 metre above the calibrator due to fire hazard.
- **Never** use heat transfer fluids such as silicone, oil, paste, etc. in the dry-block calibrators. These fluids may penetrate the calibrator and cause electrical hazard, damage or create poisonous fumes.
- Use protection shield when calibrating at high temperatures (RTC-700 and PTC-660)
- The RTC-159 and PTC-125 contains R-1270 and R-704 under pressure. The calibrator must **under no conditions** be stored at ambient temperatures above 50°C (122°F) or operated at ambient temperatures above 40°C (104°F). Doing so may cause a hazard.
- Remember to use appropriate protective equipment or get help when carrying the calibrator (for a longer distance) in order to prevent injuries from dropping the calibrator.

About the front panel:

- For B and C versions only, the sockets on the input module must **NEVER** be connected to voltages exceeding 30V with reference to ground. Thermostats must not be connected to any other voltage sources during test.

About the liquid bath (RTC-158/168/250 A/B/C only):

- For liquid bath ensure that the sensor is absolutely clean and dry as a few drops of water in the well (liquid baths) might cause a steam explosion.
- **Do not pour** cold fluid into a hot well – it might cause an explosion.
- AMETEK Denmark A/S **does not** take any responsibility, if the well is filled with other fluids than those recommended.
- Liquid baths should **only** be operated by trained personal.
- Heat transfer fluids must **only** be used in calibrators prepared as a liquid bath. If these fluids are heated above specified temperature they will create noxious or toxic fumes. Proper ventilation must be used.
- To avoid hazards from treating fluids in a wrong manner, **always** reduce the "Max. SET-temperature allowed" in the CALIBRATOR SETUP MENU according to the specifications of the fluid to be used.
If using a calibrator outside of the fluids specifications there is a risk of fire hazards, personal Injury or chemical release.
By reducing the "Max. SET-temperature allowed", the calibrator cannot be used outside this temperature range.
Be aware of the flash point, the boiling point and other fluid properties applicable to the usage when setting the Max. SET-temperature. Read the MSDS (Material Safety Data Sheet) of the liquid before use. The Max. SET-temperature must never exceed (liquid flash point – 50°C).
- Product information on the fluid must be carefully investigated before use.
- **Do not** handle hot fluid.
- If the oil is heated beyond the flash point, it may constitute a fire hazard.
- **Do not pour** water or any other fluids into a bath filled with hot oil, because only a few drops of water might cause a steam explosion, if poured into above 100°C hot oil.
- **Do not** under any circumstances pour water on burning oil. It might cause a dangerous steam explosion.



Note...

The instrument must **not** be exposed to draughts.

3.1.1 Setting up a dry-block calibrator

Follow the instructions below before using the calibrator:



Warning

Always position the calibrator to enable easy and quick disconnection of the power source (mains inlet socket).

1 Place the calibrator on an even horizontal surface where you intend to use it.



Caution...

- **Do not** use the instrument if the internal fan is out of order.
- The well **must** be clean before use.

2 Ensure a free supply of air to the internal fan located at the bottom of the instrument (pos. 2). The area around the calibrator should be free of draught, dirt, flammable substances, etc.

3 Check that the fuse size corresponds to the applied voltage on (pos. 3). The fuse is contained in the power control switch (on/off switch). To check; follow the procedure in the RTC Reference manual, 127139 section 3.1.1. and in the PTC Reference manual, 127915 section 3.2.1.

4 Check that the earth connection for the instrument is present and attach the cable below the power control switch.

5 Select an insertion tube with the correct bore diameter matching the sensor to be calibrated. Ensure that both the well and the insertion tube are clean. Insert the tube into the well as shown in fig 1.

6 Place the sensor under test and the reference/DLC sensors – if available in the insertion tube as shown in fig. 1.

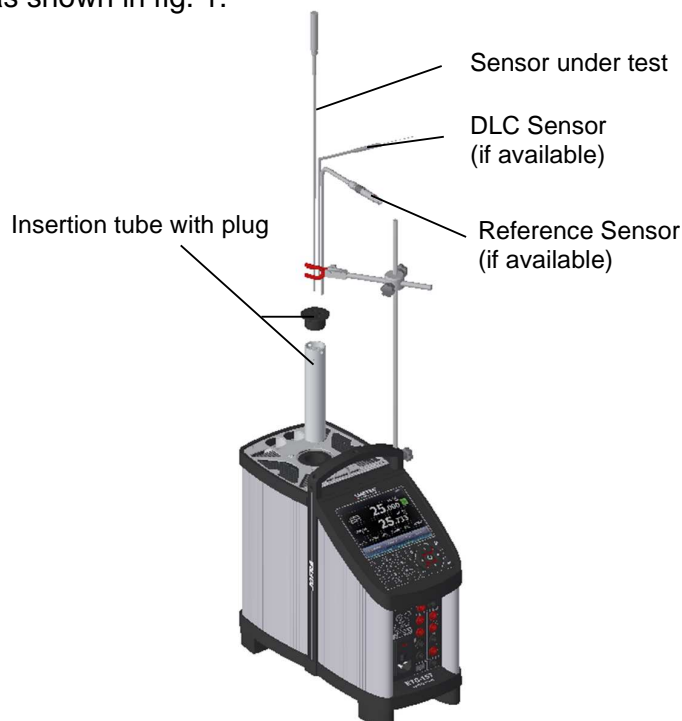

Fig. 1

Inserting sensors and insertion tube

3.1.2 Setting up a liquid bath calibrator (RTC-158/168/250 only)

Follow the instructions below before using the calibrator.



Warning

Always position the calibrator to enable easy and quick disconnection of the power source (mains inlet socket).

1. Place the calibrator on an even horizontal surface where you intend to use it. Place it in a way that will minimize the risk of tilting. It is recommended to cover the surface with a disposable cover in order to protect the surface against the silicone oil, if spilled. It is also recommendable to have a sufficient amount of disposable paper towels within reach.



Caution...

- To reduce the risk of overpressure in the well, ensure that the sealing lid on the spill tray is removed before any use of the calibrator.
- **Do not** use the instrument if the internal fan is out of order.
- The well **must** be clean before use.

2. Ensure a free supply of air to the internal fan located at the bottom of the instrument (pos. 2). The area around the calibrator should be free of draught, dirt, flammable substances, etc.
3. Check that the fuse size corresponds to the applied voltage on (pos. 3). The fuse is contained in the power control switch (on/off switch). To check; follow the procedure in the reference manual, 127139 section 3.1.1.
4. Check that the earth connection for the instrument is present and attach the cable below the power control switch.
5. Place the parts from the liquid bath kit in the well in the following order (see Fig 2a+b):
 - **Bottom shield** – It is very important that the bottom shield is placed in the well before any calibration is attempted, as the bottom shield protects the well from being damaged during calibration. For RTC-168 the bottom shield is an integrated part of the sensor basket.
 - **Stirring magnet** – It is very important that the stirring magnet is in place and spinning before any calibration is attempted. The stirring magnet ensures minimum temperature gradient in the fluid. The magnets teflon cover will over time be worn down, leaving the magnet flat on one side. This will reduce the spinning ability. A magnet with a flat side must therefore be replaced.
 - **Sensor basket** – It is very important to place the sensor basket and temperature equalizer tube in the well, as it ensures that the sensors encounter maximum temperature stability and uniformity while ensuring that the stirring magnet is not blocked
 - **Silicone oil** – Fill the well with oil according to the tables of recommended oil volume listed below. The recommended volumes must be adjusted to the actual job. For further oil information – see reference manual 127139, section 3.4.2.



The sensor basket is marked with an optimum fluid level mark (100%). When filling the well with fluid and placing the sensors, this mark must **never** be exceeded.

RTC-250 A/B/C
For recommended 50 cSt oil

0°C - 50°C	100%
50°C - 100°C	95%
100°C - 150°C	90%
150°C - 200°C	85%
200°C - 250°C	80%

RTC-158/168 A/B/C
For recommended 5/10 cSt oil

-30°C - 25°C	100%
25°C - 60°C	95%
60°C - 110°C	90%
110°C - 163°C	85%

Fig. 2a
Inserting the liquid bath kit
RTC-168



Fig. 2b
Inserting the liquid bath kit
RTC-158/250

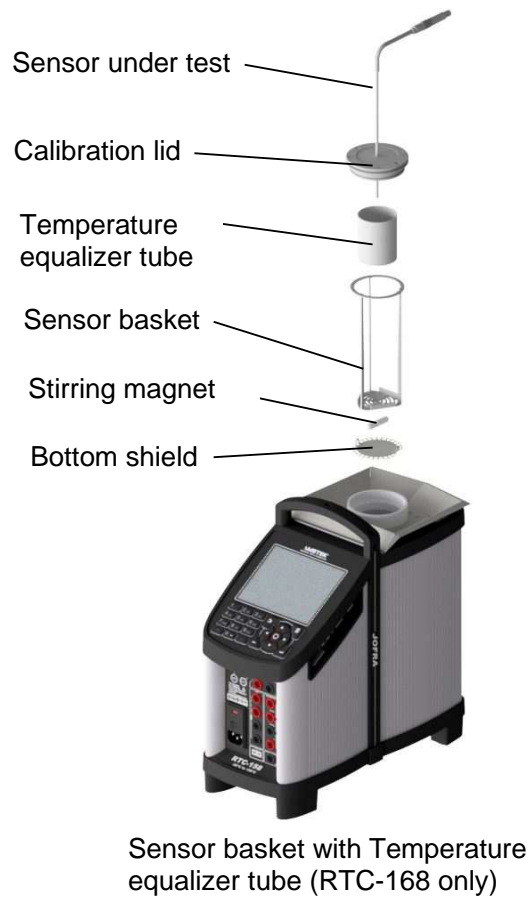



Warning

- When using liquids in the calibrator, ensure proper ventilation or local extraction to handle vapor and other airborne particles, as recommended for the particular liquid in accordance with the MSDS (Material Safety Data Sheet) of the liquid and the local environmental regulations.
- To reduce the risk of overpressure in the well, ensure that the sealing lid on the spill tray is removed before any use of the calibrator.
- When removing the sealing lid on the spill tray, be aware of overpressure in the well which can cause debris to be scattered. To reduce the risk of overpressure, only remove the lid when the well and liquid is tempered. Always use proper protective tools to avoid unwanted liquid contact to eyes, skin, clothes, or other equipment.
- Only apply the sealing lid onto the well when the liquid is tempered, to reduce the risk of pressure differences due to temperature expansion/compression.
- **Do not** handle hot fluid.
- **Do not pour** cold fluid into a hot well – it might cause an explosion
- **Do not pour** water or any other fluids into a bath filled with hot oil, because only a few drops of water might cause a steam explosion, if poured into e.g. above 100°C hot oil.
- If the fluid is heated beyond the flash point, it may constitute a fire hazard.
- AMETEK Denmark A/S **does not** take any responsibility, if the well is filled with other fluids than those recommended.

If the fluid has caught fire, switch off the main power to prevent further heating of the fluid. Flames are best extinguished by covering the well with a non-flammable lid.



Caution...

- In case of liquid liquid spillages into holes, slots or crevices in the calibrator, attempt to wipe up the liquid as soon as possible. If the liquid is electrically conductive or corrosive, immediately power off the calibrator and send in the calibrator for service.
- Do not use any alkali, acid or ionic fluids in the aluminium well as it might be damaged.
- Be careful **not to overfill** the well with liquid.
The silicone oil level rises several centimetres when the temperature is rising to maximum. To stop the overflow switch off the mains power or set a low temperature and the oil level will decent.
- **Do not** attempt to remove hot fluid with the liquid drainage syringe, as it might melt.

6 Switch on the calibrator and start the stirring magnet by following the procedure in section 4.12.



Warning

Always set the “Max. SET-temperature” of the calibrator according to the specified temperature range of the liquid. The “Max. SET-temperature” must never exceed the flash point or the boiling point of the liquid.

7 Select a SET-temperature according to the tables of recommended oil volume by following the procedure in section 4.6.

8 Carefully monitor the oil level in the well, as the temperature rises, to prevent overflow.

- 9 Place the calibration lid (see fig. 2a+b) onto the well. Holes with a boring diameter matching the sensors to be calibrated must be drilled into the lid before using it.
- 10 Place the sensor under test (see fig. 2a+b) and the reference sensor – if available - to be calibrated vertically into the well. It is recommended to use the optional support rod set for a correct position during calibration.



Caution...

- The tip of the sensor should rest at the bottom of the sensor basket for optimum results.
- Be careful **not to** submerge the handle or wire inlet of the sensor-under-test in the fluid, as this might damage the sensor.

Start the calibration of either the dry-block calibrator or the liquid bath calibrator following the calibration procedure in this manual.

3.2 During use



Caution – Hot surface



This symbol is visible on the grid plate.

- **Do not touch** the grid plate, the well or the insertion tube while the calibrator is heating up – they may be very hot and cause burns.
- **Do not touch** the lid or the spill tray when the calibrator is heating up – they may be very hot and cause burns (liquid baths only).
- **Do not touch** the tip of the sensor when it is removed from the insertion tube – it may be very hot and cause burns.
- **Do not touch** the handle of the calibrator during use – it may be very hot and cause burns.
- **Do not** remove the insert from the calibrator before the insert has cooled down to less than 50°C/122°F.



Caution – Cold surface

- If the calibrator has reached a temperature below 0°C/32°F, ice crystals may form on the insertion tube and on the well. This, in turn, may cause the material surfaces to oxidize.

To prevent this from happening, the insertion tube and the well must be dried. This is done by heating up the calibrator to min. 100°C/212°F until all water left has evaporated.

Remove the insulation plug while heating up.

It is very important that humidity in the well and insertion tube is removed to prevent corrosion and frost expansion damages.

- **Do not touch** the well or insertion tube when these are below 0°C/32°F – they might create frostbite.



Caution...(liquid baths only)

- Before use, ensure that all external equipment and accessories in contact with the liquid is suited to this exposure.
- Be careful to select the right fluid for the right task. Using other than the recommended fluids might cause damage to the calibrator or degrade the performance.
- In case of liquid spillages into holes, slots or crevices in the calibrator, attempt to wipe up the liquid as soon as possible. If the liquid is electrically conductive or corrosive, immediately power off the calibrator and contact the dealer to send in the calibrator for service.
- It is vital that the stirring magnet is in place and spinning before any calibration attempts. The spinning magnet ensures optimum temperature uniformity in the oil.
- It is strongly recommended to leave the lid on during calibration. Calibration without the lid may affect the temperature stability and uniformity.
- When heated to high temperatures, the liquid bath calibrator should be placed under a exhaust hood to remove any vapors given off by the oil.









3.3 Programming intelligent sensors

Use the configuration software CON050 supplied with RTC/PTC to program and to update calibration information in intelligent sensors.

For instructions read the software manual for CON050

3.4 Keyboard

The keys on the keyboard activate the following functions:

Keys	Description	RTC	PTC
	Full colour VGA display (main screen display information – see section 3.5)	X	X
0-9	NUMERIC KEYS to select menu options displayed in the horizontal and vertical menus and to type in values	X	
	BACK KEY to cancel a selection/edit or return to previous menu.	X	X
	MENU KEY shows the vertical menu options listed. Can be displayed all through the process	X	X
	DELETE KEY deletes previous character	X	
	ENTER KEY accepts selected options or entered values. When a value is entered with the ENTER KEY the cursor selects the next value field in the list.	X	
	ARROW KEYS have different functions depending on the mode of operation. In navigation mode, they move the cursor in the desired direction. In edit mode they roll in the list of options or if entering a number, the <i>ARROW left</i> and <i>ARROW right</i> move the cursor one character in the desired direction	X	X
	ACTION KEY opens and closes edit fields or a menu button. The action key also accepts the selected option or entered value.	X	
	ACTION KEY and ENTER KEY ACTION KEY opens and closes edit fields or a menu button. The action key also accepts the selected option or entered value.		X

3.5 Main screen display

Main screen display

The Main screen display is divided into five separate areas.

This image shows the RTC main screen display:



Pos.	Description	RTC	PTC
1	Heading: Informs you of the current menu selected.	X	X
2	Setup field: Provides the bulk of setup data in the menu. This data can be changed by moving the cursor to the various fields.	X	X
3	Horizontal menu: Provides you with the relevant menu options that can be selected at the present point. Each option can be activated either by selecting and activating the option – or simply by pressing the numeric key that corresponds to the option number.	X	X
4	Readings: This reading line is always visible and informs you of the current readings.	X	X
5	Vertical menu: This menu can be activated throughout the entire calibration. The menu can be switched on and off in all stages of operating the calibrator.	X	X

Main screen display information

The main screen gives an overview of the calibrator status and reads out the most relevant readings. In the Sensor Setup menu (see section 4.10) these readings can be changed.

This image shows the RTC main screen.

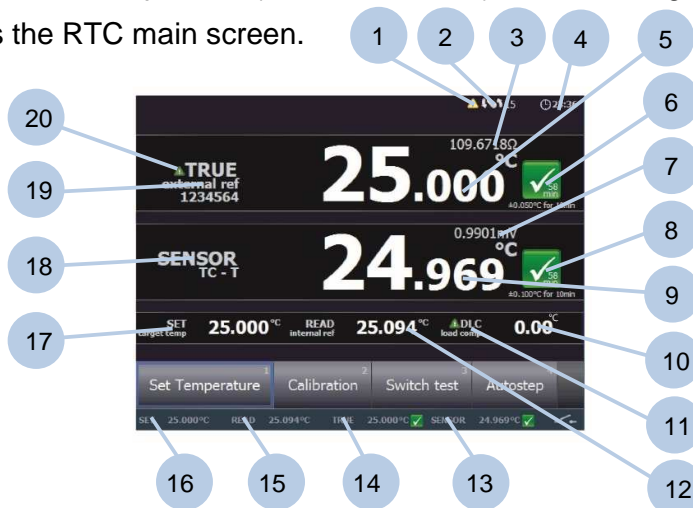

Pos.	Description	RTC	PTC
1	WARNING/ERROR symbol. The yellow icon indicates a warning. The red icon indicates an error. When the error symbol is displayed the calibration results cannot be saved. See the reference manual for details concerning warnings and errors.	X	X
2	Stirrer activated/speed indicator. The icon indicates that the stirrer is activated and the speed setting (0-100) (RTC-158/168/250 only).	X	
3	Resistance of external reference sensor when external reference sensor is selected as TRUE. (Optional - PTC)	X	X
4	Real Time Clock display	X	X
5	True temperature reading. Can be either the internal reference sensor or an external reference sensor.	X	X
6	Stability indicator displays the status of the True temperature stability	X	X
7	Sensor under test value in ohm/mV/mA. (Optional - PTC)	X	X
8	Sensor Under Test Stability indicator. If Sensor under Test stability criteria is selected, a symbol will indicate the stability of the sensor under test as well as the True sensor.	X	X
9	SENSOR. Sensor Under Test value	X	X
10	DLC sensor reading. Displays the measured temperature load of the insert –if the load compensation is active, the DLC system will control this value towards 0.00°C.	X	
11	DLC compensation activated. The icon indicates, that the Dynamic Load Compensation function is active	X	
12	READ value. The internal reference is always displayed as READ value.	X	X
13	SENSOR value always visible.	X	X
14	TRUE value always visible.	X	X
15	READ value always visible.	X	X
16	SET reading always visible.	X	X
17	SET temperature.	X	X
18	Sensor Under Test Type.	X	X
19	Set follows True activated.	X	X
20	Reference Sensor Info.	X	X

3.6 Standard connections

Communication connections

This image shows the RTC-model.

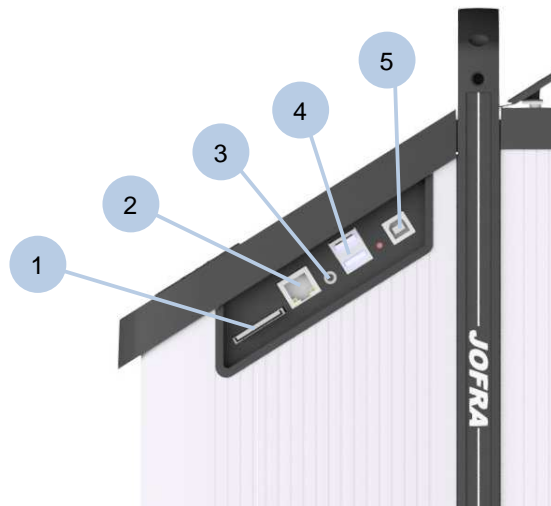

Pos.	Description	RTC	PTC
1	SD-card: SD/MMC card slot	X	
2	Ethernet: Ethernet MAC 10/100 base-T, RJ45	X	X
3	Sync.: Sync. Relay output, 3.5 mm Mini Jack	X	
4	Host: USB 2.0 Double Host Port, 2 x USB A	X	X
5	Device: USB 2.0 Device Port, 1 x USB B	X	X

3.7 Input sections (B and C versions only)



Warning

The input terminals must **NEVER** be connected to voltages exceeding 30V with reference to ground.

Description of sockets for external connections

This image shows the RTC-model.

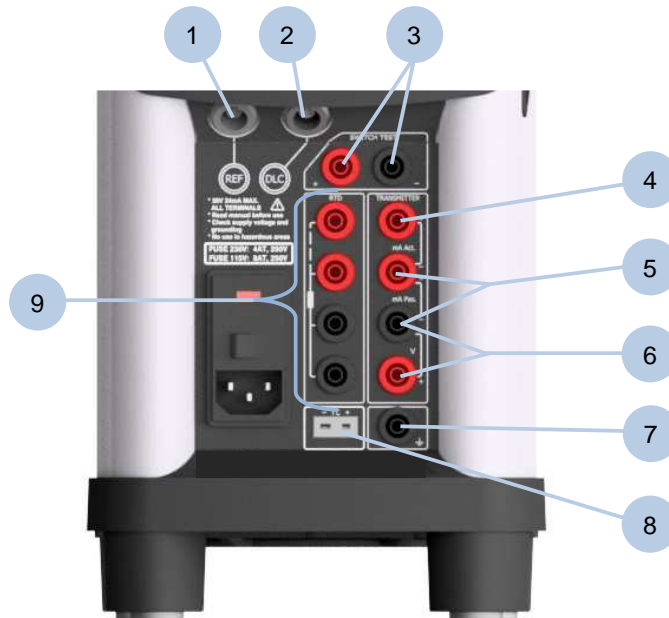

Pos.	Description	RTC	PTC
1	Input for reference sensor (B and C versions)	X	X
2	Input for DLC sensor (B and C versions)	X	
3	Connection for thermostat switch test (B-version) Note that this connection is for voltage free switches	X	X
4	24V supply for active mA input (B-version)	X	X
5	Passive mA input (B-version)	X	X
6	Voltage input (B-version)	X	
7	Connection to chassis (earth/ground) (B-version)	X	X
8	TC connection for thermocouples (B-version)	X	X
9	Input for RTD sensor (2, 3 or 4 wire) (B-version)	X	X

One of the inputs either pos. 5, 6 (only RTC), 8 or 9 can be selected displaying the “SENSOR” temperature in the Setup and pos. 1 can be displayed as “TRUE” temperature.





Note...

Only the sensor type, which is to be tested, should be connected to the input panel.

3.8 Stability of temperature values

The stability of the TRUE and SENSOR temperatures are indicated by the following messages:

-  : "Not stable": Indicates that the measured temperature is not yet within the specified stability criteria.
-  : Indicates "Time to stable": The temperature changes are within the specified stability criteria (see chapter 8.0) and states a time (in minutes and seconds) when the stable situation can be achieved.
-  : Indicates that the "stable" situation is achieved.

4.0 Operating the Calibrator



4.1 Operating principle

Note...

Please note that the keyboards of the RTC and PTC instruments are different. **Only** the RTC-models have NUMERIC keys and ENTER key. Whenever the NUMERIC keys and ENTER key are mentioned in this manual, the text is referring to the RTC-models only.

The calibrator is operated using the horizontal and the vertical menu list.

The NUMERIC keys (**RTC-models only**) are used for selecting and activating the various menus and functions from both the horizontal and vertical menu lists.

The  (ACTION key) (**RTC and PTC models**) and  (ENTER key) (**RTC models only**) are also used for selecting and activating the menus and functions and for accessing various parameters in setup fields.

The  (ARROW keys) (**RTC and PTC models**) are used to move from menu item to menu item in the menu lists, to access various result lists, to scroll through various lists and to access setup fields.

The RTC main screen display



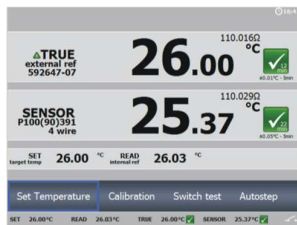

The PTC main screen display



4.1.1 Horizontal Menu

The horizontal menu options apply to the displayed screen. It is dynamically giving the relevant choices during operation. Each menu function can be activated in 2 ways:

- A. Move the blue cursor with the ARROW key  to mark the menu button on the screen. Then press  or  to activate the selection.
- B. Whenever the menu is visible simply press the NUMERIC key (RTC only).

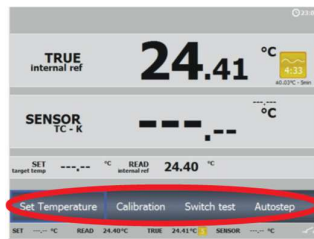
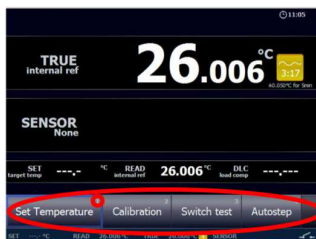

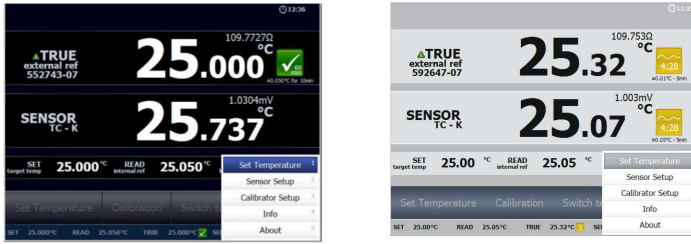

4.1.2 Vertical Menu

The vertical menu list can be called at any stage of operation making it possible to jump to the desired menu.







This allows you to jump to the most used menu easily - no matter where you are.

1. Press the  button to access the menu. To exit the menu, press the button again or  (BACK).

This menu always gives the same options, however at some points some choices are not relevant and will therefore be shaded, i.e. you can not set a temperature, when an Auto step procedure is running.

Each menu function can be activated in 2 ways.

- A. Move the cursor with the ARROW keys  or  to mark the menu field on the screen. Then press  or  to activate the selection.
- B. When the menu is visible simply press the NUMERIC key (RTC only).

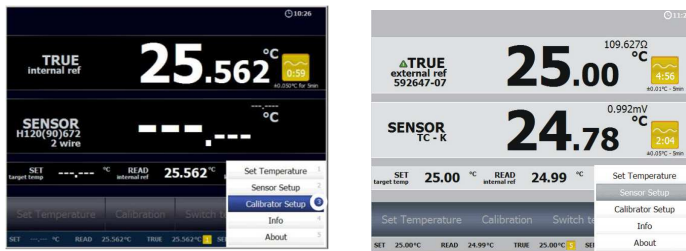

4.4.3 Parameter Fields

The setup menus have fields for parameter entries. When the setup is entered, then focus will be on the horizontal menu, and the function here can be activated.



1. By pressing the ARROW UP key  focus will move from the horizontal menu to the parameter field area.

The parameter field area focus is indicated by

- The horizontal menu is now shaded
- The parameter field area has a blue frame (RTC only)
- The selected parameter field highlighted with a dark blue color (RTC only)
- The selected parameter field is highlighted with a dark grey colour (PTC only)

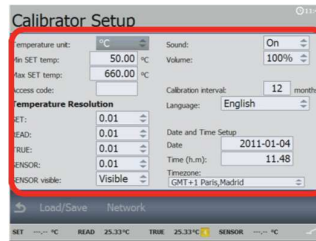
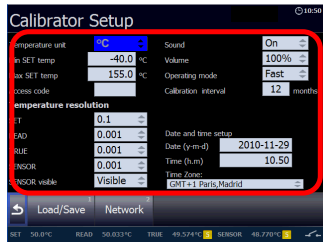

Use the 4 ARROW keys to move between the parameter fields.

A parameter value is changed by:

1. Pressing or to open the field for editing.
A numeric field can be entered directly without opening it first – simply enter the number (RTC only).
2. Press one of the 2 ARROW keys or to move between the numeric fields (PTC only).
3. Enter a numeric field by pressing either or (PTC only).
4. When the parameter is entered press one of the keys:

This enters the value and leaves the cursor on the parameter field.

This enters the value and moves the cursor to the next parameter field.

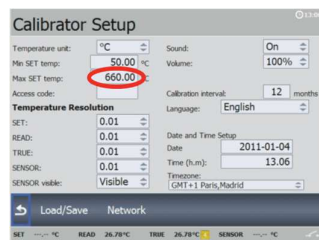
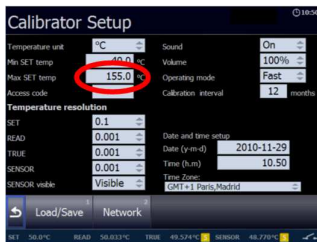

4.4.4 Working with lists

When it is possible to choose between a number of data sets, the data sets are presented in lists.

1. As an example access the Calibrator Setup menu from the vertical menu and activate “Load/Save”

A list of instruments settings will be displayed.

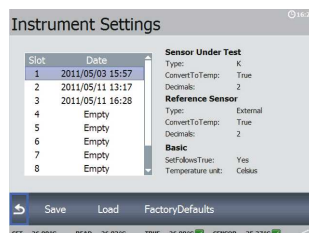

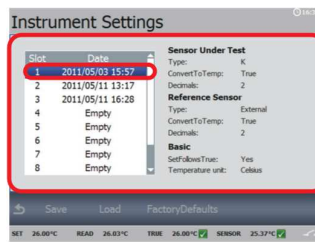
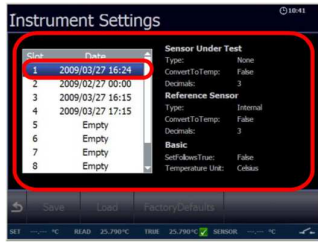

- Press ARROW UP ▲ to move the focus from the horizontal menu to the list.

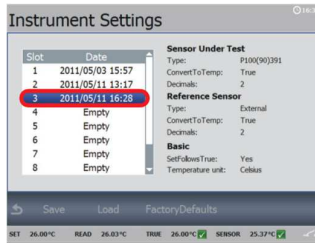
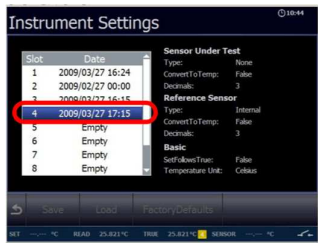

The selected data set in the list is now highlighted with a dark blue color.

- Scrolling in the list is done using the ARROW UP key ▲ and the ARROW DOWN key ▼.



- When the desired dataset in the list is highlighted press  or .

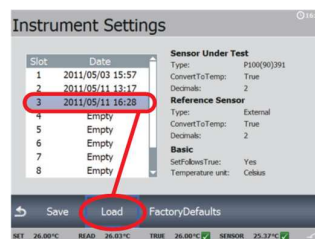
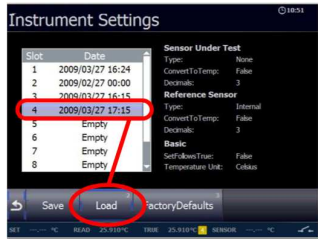



Now the horizontal menu will be in focus again and here you are able to decide what to do with the chosen dataset.

Activate the desired function in the horizontal menu. In this example the highlighted Instrument Settings will be loaded from the memory into the active setup.

Some lists have no horizontal menus and only one option available.

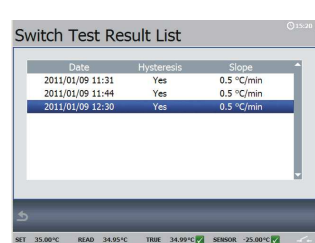
- As an example access the Switch test menu by selecting “Switch test” from the main menu and then activate “Results”.



6. Scroll through the list using the ARROW UP key ▲ and the ARROW DOWN key ▼ and just press  or  to display the result of the highlighted dataset.

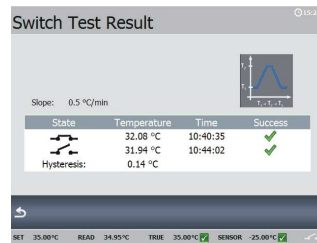

4.5 Starting the calibrator

Switch on the calibrator using the power control switch. A start up screen is displayed and then replaced with the main menu screen:

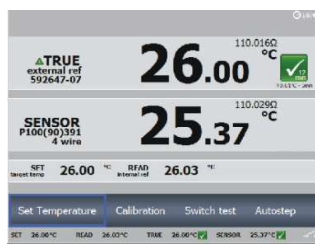
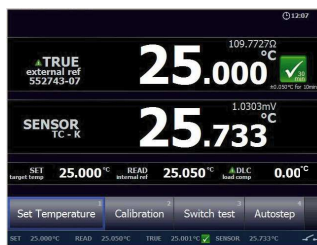



The functions in the horizontal menu are available using the soft keys or the arrow keys on the keyboard (see description in section 3.4).

4.6 Setting the temperature

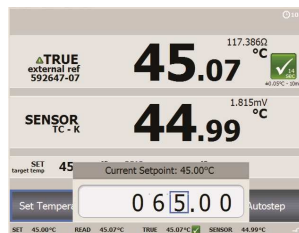
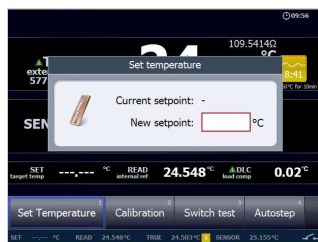
1. Access the Set Temperature function by selecting “Set Temperature “.



For RTC models

Use the NUMERIC keys to enter a new value, or  or  to accept the value. When pressing the ACTION key or the ENTER key the calibrator returns to the main menu screen.

For PTC models

Use the ARROW keys to enter a new value, and  to accept the value and return to the main menu screen. If pressing the BACK key the calibrator returns to the main menu screen without accepting the new value.

The Set temperature function can also be accessed using the vertical menu (press ). Through this menu a new set point value can be entered at any stage of the operation **except when one of the automatic functions is active.**

4.7 Calibration (optional - PTC)



Note...

This Calibration function is for B versions only.

This function enables you to perform automatic calibrations of different temperature sensors. The calibration procedure is semi-automatic, using parameters and settings, which are defined in workorders. These workorders are created and edited using the "JOFRACAL" PC program. Multiple calibrations can be performed using the same workorder settings.

1. Access the Calibration menu by selecting "Calibration" from the main menu.

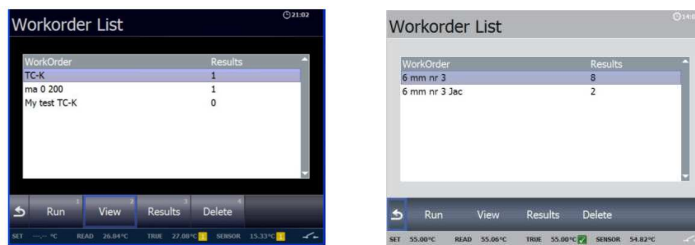

A Workorder List is displayed.

2. Run the selected workorder by activating "Run". A new calibration is started.

You can also chose to activate:

- "View" – shows the setting of the workorder.
- "Results" – shows the previous calibration results from this workorder.
- "Delete" – deletes the workorder setting and the results.

For operating the Results menu see section 4.7.2.

For operating the View menu see section 4.7.3.

For operating the Delete function see section 4.7.4.

4.7.1 Running a calibration

1. To run the calibration, select "Run" from the Workorder List menu.

If the serial number of the reference sensor used for calibration does not match the one specified in the workorder the following message is displayed :



If you proceed, the connected reference sensor will be documented along with the results.

If you do not wish this message to appear, the correct reference sensor must be specified when the workorder is edited using the "JOFRACAL" PC program.

2. Choose "YES" and press or if you want to proceed with the calibration.

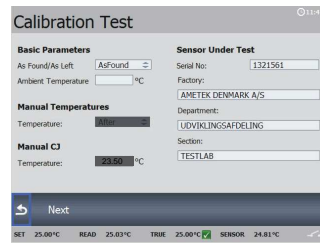

The Parameter setup menu is displayed.



Note...

If the sensor under test is a thermocouple sensor and the manual compensation mode is selected in work orders, a cold junction temperature must be defined.

The parameters in the workorder can be edited.



Note...

- Only numeric data can be entered.
- The BACK key  cancels a selection/edit or returning to previous menu. The ESC key can be used throughout the process.

3. Select “Next “ to proceed with the operation.

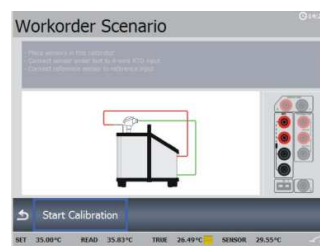
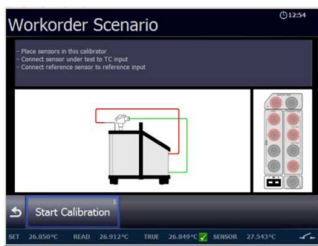

A workorder Scenario is displayed, giving a graphical display of the setup and sensor connections.

4. Start the calibration by selecting “Start Calibration”.

The Calibration Running step 1 of 2 is started and the temperature is heading towards step 1.

The following screen is displayed :



When the temperature has reached the stable criteria, the calibration data will be stored and the temperature goes towards the next set temperature.

If the workorder contains manual reading during calibration, you will be asked to enter the Sensor Under Test temperature before that.

The following screen is displayed :

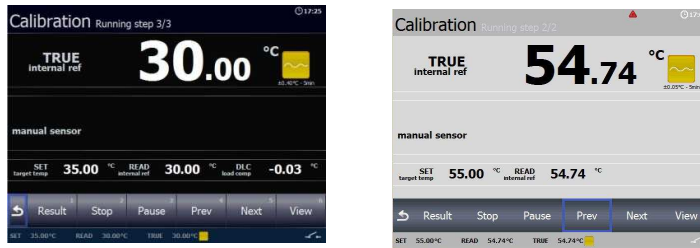

If manual readings are specified these will have to be entered before next step starts.



Note...

The calibration can be stopped at any time by activating “Stop”, but this will erase the calibration results.

During calibration several other functions are available:

- “Result” - To view the calibration results (no editing is possible).
- “Pause” - To pause the calibration.
- “Prev” - Force the calibration to jump a step backwards to the previous calibration screen regardless of the calibration stability.
- “Next” - Force the calibration to jump a step forwards to the next calibration screen regardless of the calibration stability. This will leave the current step without saving calibration results.
- “View” - To view the workorder settings.

When the calibration has completed a green check ✓ is shown on the screen and the Calibration Result follows quickly hereafter.



5. Select “Save” to store the results in the calibrator

or

select “Discard” and press “Yes” to delete the calibration results or “No” to return to the Calibration Result screen.

A full Calibration Result List can be viewed using the instructions in section 4.7.2.

4.7.2 Viewing calibration results

1. Access the Calibration Result function by selecting “Results” from the Workorder List menu.



A full Calibration Result List is displayed.

2. Select a workorder to be displayed showing the calibration details for the specific workorder.



3. The calibration results can be uploaded with the “JOFRACAL” PC program. This enables you to print out the results on a certificate.
4. Press  to exit the Calibration Result List and return to the Workorder List menu.

4.7.3 Displaying calibration information

Calibration information is defined within the work orders created on the PC using "JOFRACAL".

1. Access the Workorder Sensors menu by selecting “View” from the Workorder List menu.

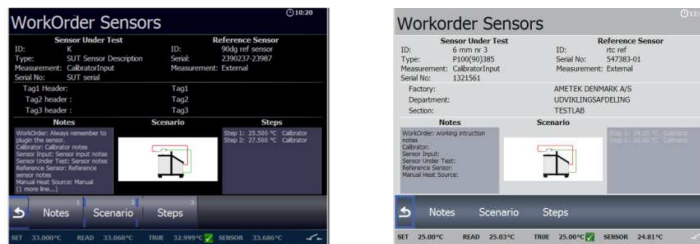

The Workorder Sensors menu is displayed.

This screen gives you an overview of the workorder sensor setup including a summary of Notes, Scenario and Steps. Each of these can be displayed in details.

2. Select “Notes” to access the Notes function.

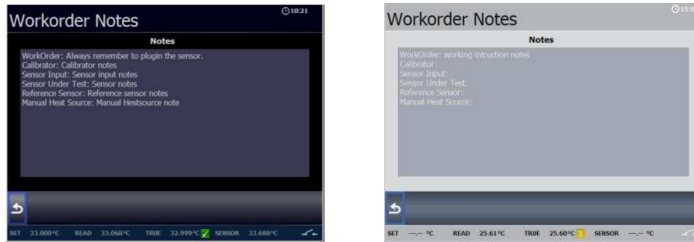

A list of Workorder Notes is displayed.

The notes are information entered via the PC program, when the workorder is created.

3. Press  to exit the Workorder Notes screen.
4. Select “Scenario” to access the Scenario function.

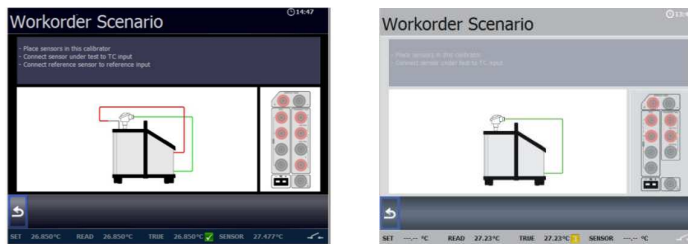

A Workorder Scenario is displayed.

The calibration set up is shown in a graphic format, and the active sensor input is marked. The parameters for this setup are defined in the work order created using the PC program.

5. Press  to exit the Workorder Scenario screen.
6. Select “Steps” to access the Step function.

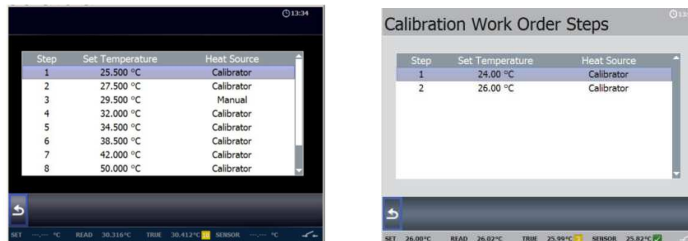

A list of Temperature Steps is displayed.

This function shows the pre-defined temperature steps for the calibration.

7. Press  to exit the Step function and return to the Workorder Sensors menu.

4.7.4 Deleting workorders

It is possible to delete a workorder using the Delete function from the Workorder List menu.

1. Select “Delete” to access the Delete function.

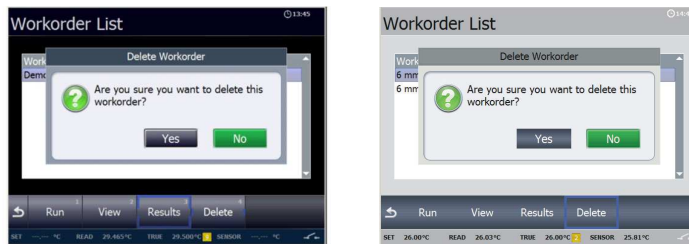

2. Press “Yes” if you want to delete your workorders and “No” if you want to exit the Delete function without deleting anything.



Warning

If you choose to delete a workorder, the whole workorder including the calibration results will be deleted.

3. Press  to exit the Workorder List menu and return to the main menu.

4.8 Switch test menu



Note...

This Switch test function is for B versions only.

Switch test automatically locates the switch temperatures of a thermostat.

Three parameters are required:

- Start temperature (T_1)
- End temperature (T_2)
- Rate of change in temperature (slope rate).

Hysteresis of a thermostat can also be determined here.

4.8.1 Running a switch test



Note...

Temperature range is limited by Min. SET Temp. and Max. SET Temp. settings editable in the System Settings menu and by the temperature range of the external reference sensor, if connected.

1. Access the Switch test menu by selecting “Switch test” from the main menu.

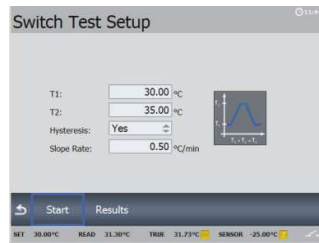

A Switch test setup menu is displayed.

The small graph illustrates the current T_1 , T_2 and hysteresis selections. Note that T_1 can be greater than T_2 .

2. Access the setup field to edit the parameters:

- T_1 - first set temperature
- T_2 - second set temperature
- Hysteresis - to determine hysteresis, toggle between "Yes" (a two-way-temperature measurement) and "No" (a one-way-temperature measurement).
- Slope rate - The permitted range is 0.1 - 9.9°C/min. / 0.2 - 17.8°F/min.



Note...

the slope rate should be set so that the thermostat sensor can follow the temperature in the calibrator's well.

3. Press  to exit the setup function and return to the Switch test setup menu.

Before starting the switch test ensure that the switch is connected to the switch input (see page 21, pos. 4).

4. Select "Start" to start the switch test.



The Switch Test is now in progress.

While the switch test is in progress, 2 options are available:

- “Result” – displaying the current switch test results.
- “Stop” – stopping the switch test. Press “Yes” to stop the switch test and “No” to return to the Switch Test screen.

4.8.2 Showing switch test results

Two types of switch test results are available:

- Results during a switch test.
- Results of a finished switch test.

Results during a switch test

1. Access the Switch Test Result List by selecting “Result” from the Switch Test menu.



Temperature	Time	Success
33.07 °C	21:55:56	✓

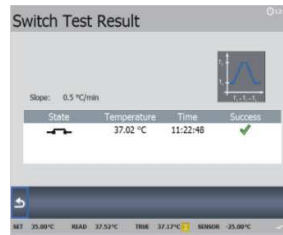

This shows the results that are currently available. These results change as the test progresses.

2. Press to return to the switch test.

Finished switch test results

At the end of a switch test the results are displayed. These show the temperature when the thermostat has closed and the temperature when it has opened – whichever comes first. The difference between these 2 temperatures is calculated as the hysteresis.

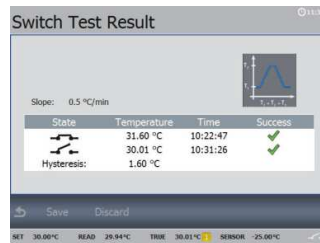

3. Select “Save” to save the results storing them in the calibrator’s memory.
4. Select “Discard” to delete the results from the screen.



Note...

A hysteresis result is only measured when hysteresis is set to “Yes”.

You will then automatically return to the Switchtest setup menu.

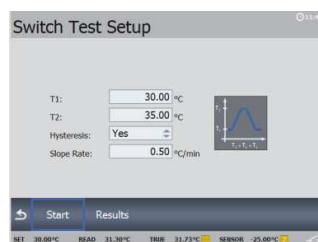

If no change in the switch position is registered during the test a red cross will be displayed in the Result list instead of a green check ✓.



5. Delete the result by selecting “Discard” or save the result by selecting “Save”.

To view stored switch test results

1. Access the Switch Test Result List by selecting “Results” from the Switch test setup menu.



2. Select a test result to be displayed.

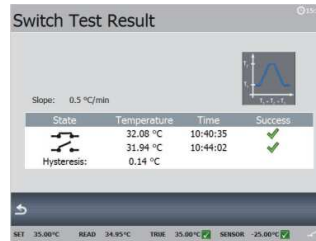

3. Press twice to return to the Switch test setup menu.

4.9 Auto step menu

Auto step is used to step automatically between a range of different calibration temperatures.

4.9.1 Running an Auto step calibration

1. Access the Auto Step Setup menu by selecting “Autostep” from the main menu.



The Auto Step Setup menu is displayed.

2. Access the Auto Step Setup to edit the parameters:

- **No of steps:** the number of temperature steps per direction ($T_1 \rightarrow T_x$) can be set using integers from 1 – 20. When a Two-way mode is selected, the same number of steps are used for the second direction ($T_x \rightarrow T_1$).
- **Mode:** toggle between “One-way” and “Two-way”.
- **Hold time:** defines the time (in minutes) the temperature is maintained (after it is stable) for each step.
- **T step values:** must be set within the sensors permitted range.

3. Press  to exit the editor and return to the Auto Step setup menu.

4. Access the Sensor setup menu by selecting “Next” from the Auto Step Setup menu.

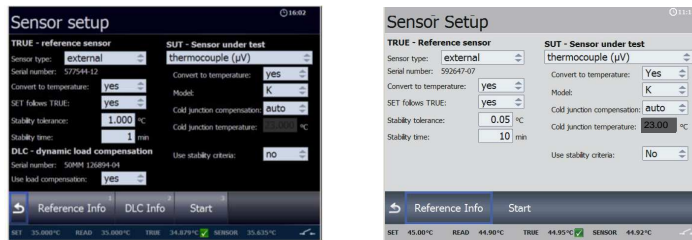

The Sensor setup menu is displayed. In this menu you have the opportunity to check and if necessary change the settings as described in section 4.10 – Sensor Setup menu.

5. Select “Start” to start the Auto Step calibration.

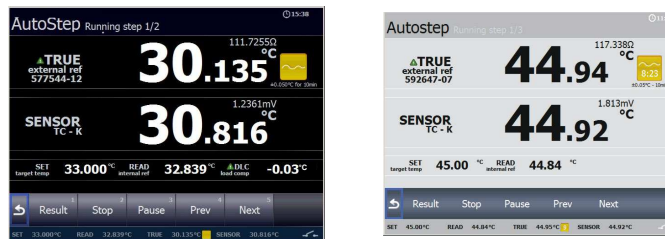

An Auto Step Running step screen is displayed.

While the step test is in progress, several functions are available:

- “Result” - To review the Auto Step results (no editing is possible).
- “Stop” - To stop the Auto Step test.
- “Pause” - To pause the test.
- “Prev” - Force the test to jump a step backwards to the previous running step regardless of the step’s stability.
- “Next” - Force the test to jump a step forwards to the next running step regardless of the step’s stability.

When the Auto Step test is complete the results are displayed.



6. Select "Save" to save the results storing them in the calibrator's memory.
7. Select "Discard" to delete the results from the screen.
The calibrator then returns to the Auto Step Setup menu.

4.9.2 Auto Step test results

At the end of an Auto Step test the results are displayed and stored in the calibrators memory.

The measured TRUE and SENSOR temperatures for each step are displayed.

To view stored Auto step test results

1. Access the Auto Step Result List by selecting "Results" from the Auto Step Setup menu.



The Auto Step Result List is displayed.

2. Select an auto step result to be displayed.



3. Press twice to return to the Auto Step Setup menu.

4.10 Sensor Setup menu

1. The Sensor Setup can be entered through the vertical menu (press)
The Sensor Setup can also be edited immediately before running the Auto step (section 4.9.1) or when starting a switch test.

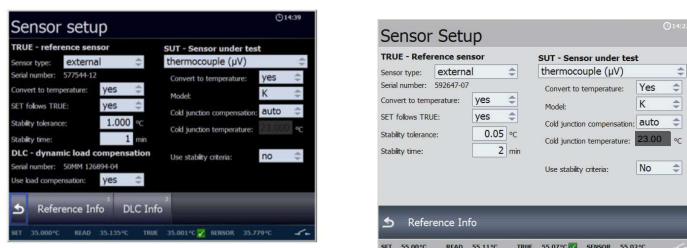

2. Activate "Sensor Setup".

4.10.1 Setting the additional stability time (A version)

1. Set the additional stability time by pressing  and the NUMERIC keys (RTC only) / ARROW keys (PTC only). Stability time can be set (in minutes) using integers from 0 – 99.

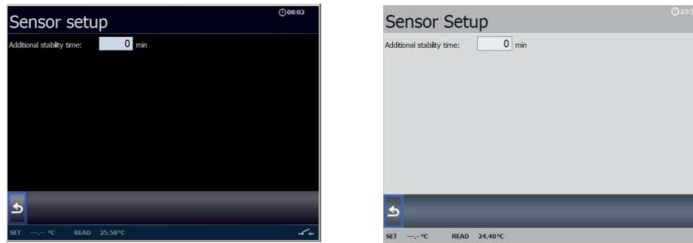

4.10.2 Setting the parameters for TRUE – reference sensor (B and C versions only)

Sensor type:

Internal reference source.

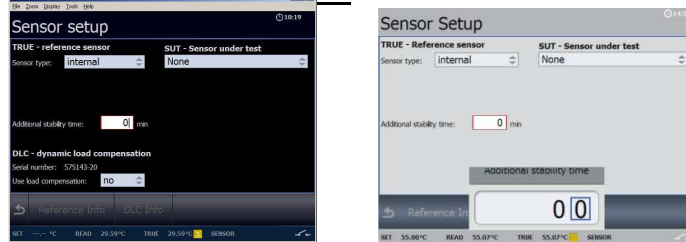

The internal reference sensor will be displayed as the TRUE value on the main screen.

The calibrator has a set of internal stability criteria it shall meet before stability is indicated. Additional stability time may be set beyond the internal stability criteria.

1. Set the additional stability time by pressing  and the NUMERIC keys (RTC only) / ARROW keys (PTC only). Stability time can be set (in minutes) using integers from 0 – 99.

External reference source

The TRUE value on the main screen will be read from the Intelligent Reference Sensor connected to the REF. INPUT on the front panel (see section 3.7 pos. 1). The calibrator automatically reads the calibration data and serial number of the Sensor.

Convert to temperature:

- “yes” sets the readout of the External reference as a temperature.
- “no” sets the readout of the External reference in Ω values.

SET follows TRUE:

This function enables you to reach the TRUE temperature measured by the External reference sensor.



Note...

that when “yes” is selected, the calibrator will control the temperature to the TRUE temperature. This means that it could take longer time before the calibrator indicates stability.

The “SET follows TRUE” function is indicated with the symbol  at the TRUE reading in the main display.



Note...

SET follows TRUE is only relevant when the External reference sensor is displayed in temperature units.

Stability tolerance:

The tolerance should be set low enough to utilize the good temperature stability of the calibrator – however a low value also gives a longer time to be stable.

Stability time:

Stability time can be set from 1 – 99 minutes.

When the TRUE temperature has reached the specified Stability tolerance during the specified Stability time, then the stability indicator in the main screen will turn green.

2. Press  to accept the new setting(s) and return to the Sensor setup menu or continue to edit the DLC sensor parameters or the Sensor under test parameters.

4.10.3 Setting the parameters for DLC– dynamic load compensation – (RTC, B and C versions only)

The DLC value on the main screen will be read from the Intelligent Load Sensor as soon as it is connected to the DLC INPUT on the front panel (see section 3.7 pos. 2). The calibrator automatically reads the calibration data and serial number of the Sensor. However if the Dynamic Load Compensation shall be active, it must be enabled.

Use load compensation:

The active “DLC” function is indicated with the symbol  at the DLC reading in the main display.



Note...

always use external reference sensor when calibrating with the DLC-function activated for specified accuracy.

1. Press  to accept the new setting(s) and return to the Sensor setup menu or continue to edit the reference sensor parameters or the Sensor under test parameters.

4.10.4 Setting the parameters for SUT– Sensor under test (B versions only)

Sensor type:

1. Choose between :
 - thermocouple sensors (μV)
 - voltage sensors (V) (RTC only)
 - current sensors (mA)
 - RTD sensors (resistance temp. detector (Ω))
 - None (no sensor connected)
2. Select a sensor.

The selected sensor and its list of parameters are now displayed. The various settings can be edited as described in the following :

Convert to temperature:

(using thermocouple, voltage, current and RTD)

- “yes” – the inputs are converted to temperatures.
- “no” – no conversion is made.
When “no” has been selected the type of model is the only other parameter which can be altered.

Model:

(using thermocouple and RTD)

1. Toggle between the models; K, L, N, R, S, T, U, B, E and J (thermocouple) or *P10(90)385, *P50(90)385, P100(90)385, *P200(90)385, *P500(90)385, P1000(90)385, *P50(90)391, P100(90)391, P100(90)392, *Pt-100 MILL, *YSI-400, H120(90)672, *M100(90)428... and *M50(90)428 (RTD).
* Optional – PTC

Cold junction compensation:

(using thermocouple)

- “auto” – when the automatic mode is selected, the calibrator measures the temperature in the T/C connector and uses this for the cold junction compensation of the thermocouple.
- “manual” – to define a manual temperature for cold junction compensation. Can be used when an external cold junction temperature can be established.

Cold junction temperature:

(using thermocouple)

1. When “manual” Cold junction compensation has been selected the temperature for cold junction can be set using the NUMERIC keys (RTC only) / ARROW keys (PTC only).

Voltage(V) and temperature(T) span (RTC only):

(using voltage)

The minimum and the maximum of the voltage and the corresponding temperature span can be set here.

1. Use the NUMERIC keys to set the value of the voltage and/or the temperature.

Current(C) and temperature(T) span:

(using current)

The minimum and the maximum of the current and the corresponding temperature span can be set here.

1. Use the NUMERIC keys (RTC only) / ARROW keys (PTC only) to set the value of the current and/or the temperature.

Number of wires:

(using RTD)

The number of wires used for the sensor under test can be selected here.

1. Choose between 2, 3 or 4 wires.

Use stability criteria:

(using thermocouple, voltage (RTC only), current and RTD)

Beside the stability check on the Reference sensor, it is also possible to ensure that the Sensor Under Test (SENSOR) is stable before the temperature is indicated as stable.

- “yes” – Stability will be checked on both Reference sensor (TRUE) temperature and Sensor Under Test (SENSOR) temperature.
- “no” – Stability will be checked on Reference sensor (TRUE) temperature only.

Stability tolerance:

(using thermocouple, voltage (RTC only), current and RTD)

1. Enter the Stability tolerance (temperature) by pressing the NUMERIC keys (RTC only) / ARROW keys (PTC only).

The expected performance of the Sensor Under Test should be considered before setting the tolerance.

Stability time:

(using thermocouple, voltage (RTC only), current and RTD)

1. Set the Stability time by pressing the NUMERIC keys (RTC only) / ARROW keys (PTC only). Stability time can be set from 1 – 99 minutes.

4.10.5 Viewing the Reference and DLC data (B and C versions only)

The calibration data of the Intelligent Reference sensor and the intelligent DLC sensor (RTC only) can be viewed using the Reference Info function or the DLC Info function (RTC only) from the Sensor setup menu.

1. View the Reference Info box by selecting “Reference Info”.

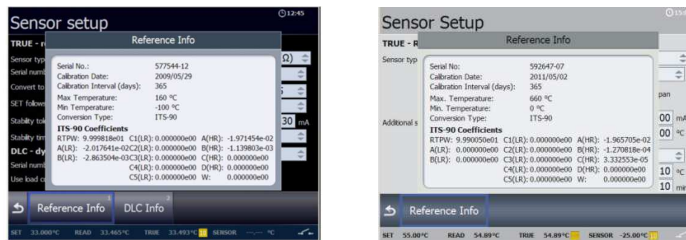

The Reference Info box is displayed.

2. Press  to return to the Sensor setup menu.
3. View the DLC Info box by selecting “DLC Info” (RTC only).

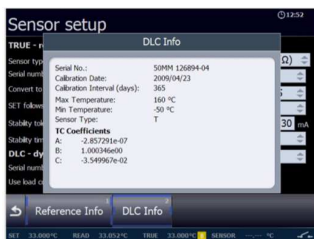

The DLC Info box is displayed.

4. Press  to return to the Sensor setup menu.

4.11 Calibrator Setup menu

1. The Calibration Setup can be edited through the vertical menu (press ).



2. Activate “Calibrator Setup”.

4.11.1 Setting the temperature parameters

Temperature unit:

1. Choose between:
 - °C (Celsius)
 - °F (Fahrenheit)
 - K (Kelvin)

Min SET temp / Max SET temp:

1. Enter the access code to get access to the editor.
2. Use the NUMERIC keys (RTC only) / ARROW keys (PTC only) to set the Min/Max SET temperature in Celsius, Fahrenheit or Kelvin.



Note...

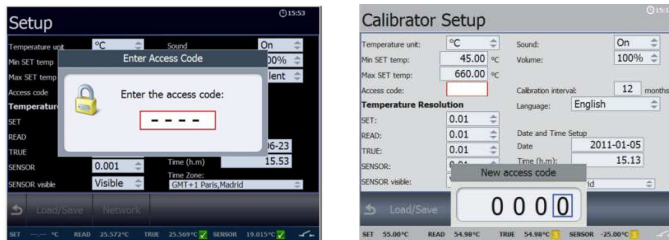

The Enter Access Code box is displayed every time you try to access the Min/Max SET temp parameters. Type in your access code and continue.



Access code:

The following features can be protected by an access code:

- Resetting the calibrator to Factory default settings.
- Setting the Min/Max SET Temperature.
- Editing the Access code while it is enabled.

1. Press  or  to access the Access code function.
2. Use the NUMERIC keys (RTC only) / ARROW keys (PTC only) to type in a value from 0000 to 9999. Use all 4 digits.
Typing 0000 disables the Access code function.

The access code is accepted showing a green check ✓ for a few seconds allowing you to continue.



Caution...

If you choose to let your access code consist of only 1, 2 or 3 digits you must enter the access code with 0 followed by the chosen value.



Example:

1. The access code 12 is selected.
2. Type in 0012 in the Enter Access Code box



Note...

The access code can be deleted allowing you to change the Min/Max SET temperature without having to enter the access code.

3. Press  or  to access the Access code function.
4. Type in your access code.
No new value is entered.
5. Accept the new setting (empty box).
It is now possible to enter the editor without using the access code.

4.11.2 Setting the temperature resolution

1. Choose between :
 - SET
 - READ
 - TRUE
 - SENSOR
2. Choose between the resolutions:
 - 0.001 (RTC only)
 - 0.01
 - 0.1

SENSOR visible:

1. Choose between :
 - Visible
 - Hidden

If the Hidden option is chosen the Sensor Under Test reading will not be displayed on the main screen.

4.11.3 Setting the sound, volume and operating mode

Sound:

1. Choose between :
 - On
 - Off

Enables the calibrator to make a sound during operation.

Volume:

1. The volume of the sound can be adjusted from 0 – 100%.

Operating mode (RTC only):

1. Choose between :

- Fast
- Silent

“Fast” – the fan operates in a fast mode giving the best performance of cooling.

“Silent” – the fan operates in a silent mode reducing the noise. Using this option the cooling process is made a little slower and the calibrator might not be able to reach the specified minimum temperature.

4.11.4 Setting recalibration interval

Sets the required recalibration interval for the calibrator.

1. Choose a value between 1 month and 99 months.

4.11.5 Changing the date and time**Date:**

1. Use the NUMERIC keys (RTC only) / ARROW keys (PTC only) to enter a new date.

The date can only be entered using the format yyyy-mm-dd. When entering the date with different format, the text will disappear when you try to accept the setting.

Time:

The calibrator is set up with a default time (present time).

2. Use the NUMERIC keys (RTC only) / ARROW keys (PTC only) to enter a new time using the format hh.mm.

Time Zone:

3. The relevant time zone is selected from a list of various zones.

4.11.6 Choosing a language (optional)

The calibrator is set up with a default language - English.

4.11.7 Saving a setup

Saving a setup saves parameters in the Setup menu.

1. Access the Instrument Settings menu by selecting “Load/Save” from the Calibrator Setup menu.

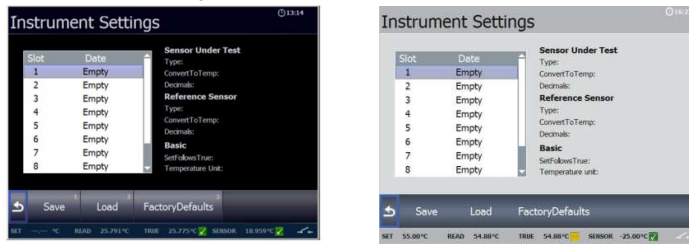

The Instrument Settings are displayed.

2. Select a register number to be used for saving.
The setup will be saved with the selected register number.



Note...

In the Calibrator Setup the following parameters will not be saved:

- Min SET temp
- Max SET temp
- SENSOR visible

You can save up to 10 setups.

When the setup is saved the parameters are visible in the right side of the screen.



4.11.8 Loading a setup

Loading a setup causes the setup parameters to be overwritten.

1. Select a setup from the list to be loaded.
The selected setup will be loaded into the calibrator's memory.
2. Press  to return to the Calibrator setup menu.

4.11.9 Resetting the instrument setup to factory defaults

Resetting to the factory default settings changes the active setup to the initial settings.

4.11.10 Network Configuration (for service use only)

1. Access the Network Configuration function by selecting “Network” from the Calibration Setup menu.

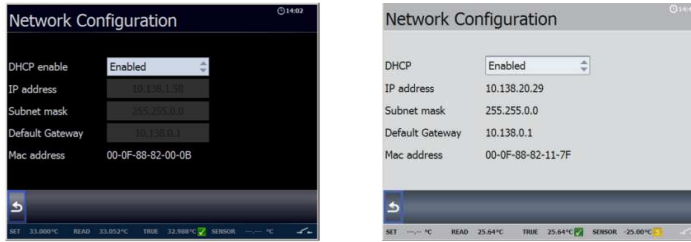

The Network Configuration screen is displayed.

When DHCP is set to Enabled, the IP address will be updated when leaving the network menu.

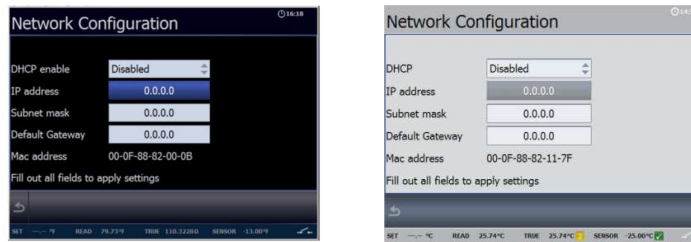

2. When DHCP is disabled, you can configure the IP-settings manually using the NUMERIC keys (RTC only) / ARROW keys (PTC only).



4.12 Selecting the stirrer speed (RTC-158/168/250 only)

1. The Set Stirrer Speed can be entered through the vertical menu (press ) Use the ARROW keys to select “Stirrer Speed”.



2. Use the NUMERIC keys to enter a value, or  or  to accept the value. When pressing the ACTION key or the ENTER key the calibrator returns to the main menu screen.
3. Select a speed setting between 0 and 100.
The normal setting is between 30 and 40.

When using the RTC-158/168/250 A/B/C with a dry block kit the stirrer speed must be set to 0.

The DLC will be disabled when the stirrer is started



Caution...

If the speed level chosen is too high, the magnet will fall off making a rattling sound and there will be no stirring in the fluid. With no stirring of the fluid, temperature gradients will emerge in the bath, which will again affect the result of the calibration.

To reconnect the magnet, set the speed level to 0 and select a speed setting lower than the previous.

4. Press or to accept the value and return to the setup menu.

4.13 Information Screen

1. Information about the status can be viewed using the Info function from the vertical menu (press).

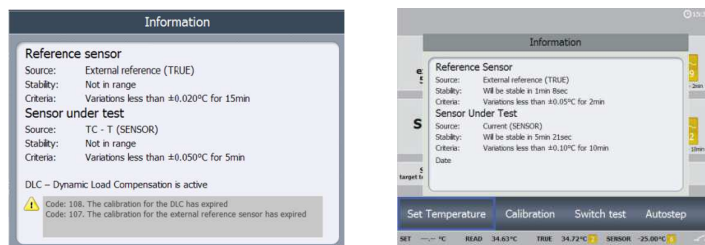

A status summary of the sensors setting and stability information is displayed.

If a warning or an error has occurred, it will be listed on the information screen.

2. Press to exit the Info function.

4.14 About the calibrator

1. Information about the calibrator can be viewed using the About function from the vertical menu (press).

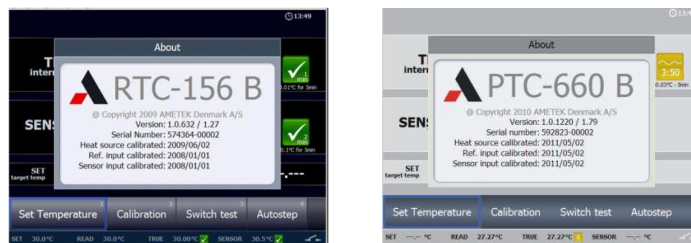

2. Press to exit the About function.

5.0 Setting the mains voltage and replacing the main fuses



Warning

- The calibrator **must** be switched off before any attempt to service the instrument is made. There are no user serviceable parts inside the calibrator.
- The fuse box **must not** be removed from the power control switch until the mains cable has been disconnected.
- The two main fuses must have the specified current and voltage rating and be of the specified type. The use of makeshift fuses and the short-circuiting of fuse holders are prohibited and may cause a hazard.

Fig. 3
Replacing fuses

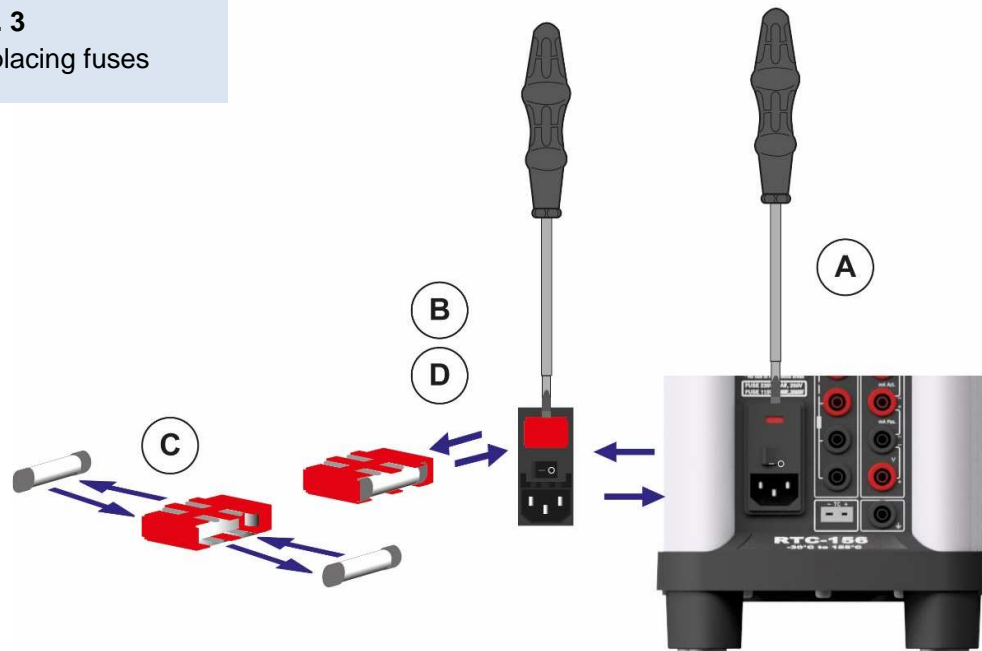

- Locate the main fuses in the fuse box in the power control switch and check the voltage of the power control switch (on/off switch (230V/115V)). If the voltage of the power control switch differs from the line voltage, you must adjust the voltage of the power control switch.
 - Open the lid of the fuse box using a screwdriver and remove the fuse box.
 - Replace the fuses. The fuses must be identical and should correspond to the line voltage.
 - RTC-156/157/158/159/168/187/: 115V 8AT = 127211 / 230V, 4AT = 127210 PTC-125/155
 - RTC-250/700/: 115V, 10AF = 60B302 / 230V, 5AF = 127573 PTC-350/25/660
- If the fuses blow immediately after you have replaced them, the calibrator should be returned to the manufacturer for service.
- Slide the fuse box into place with the correct voltage turning upwards.

6.0 After use

6.1 Storing and transporting the calibrators



Caution...

The following guidelines should always be observed when storing and transporting the calibrators. This will ensure that the instruments and the sensors remain in good working order.



Warning

- The calibrator **must** be switched off before any attempt to service the instrument is made. There are no user serviceable parts inside the calibrator.
- Remember to use appropriate protective equipment or get help when carrying the calibrator (for a longer distance) in order to prevent injuries from dropping the calibrator.

The following routine must be observed **before the insertion tube is** removed and the instrument switched off:

Dry-block calibrators only



Over 50°C/122°F

If the calibrator has been heated up to temperatures above 50°C/122°F, you must wait until the instrument reaches a temperature **below 50°C/122°F** before you switch it off.



Below 0°C/32°F

(applies only to the RTC-156/157/158/159/168/187, PTC-125/155 A/B/C models)

- **Do not** touch the well or insertion tube when these are below 0°C/32°F - they might create frostbite.
- If the calibrator has reached a temperature below 0°C/32°F, ice crystals may form on the insertion tube and on the well. This, in turn, may cause the material surfaces to oxidize.
To prevent this from happening, the insertion tube and the well must be dried. This is done by heating up the calibrator to min. 100°C/212°F until all water left has evaporated.

Remove the insulation plug while heating up.

It is very important that humidity in the well and insertion tube is removed to prevent corrosion and frost expansion damages.

1. Switch off the calibrator using the power control switch.
Note that the calibration procedure may be interrupted at any time using the power control switch. Switching off the calibrator during the calibration process will not damage either the instrument or the sensor.
2. Remove the insertion tube from the calibrator using the tool for insertion tube supplied with the instrument as shown in fig. 4.
3. **Optional:** Store the calibrator in its protective, aluminium carrying case.

Fig. 4
Removing insertion tube



Caution – Hot surface

Do not remove the insert from the calibrator before the insert has cooled down to less than 50°C/122°F.



Caution...

The insertion tube must **always** be removed from the calibrator after use.

The humidity in the air may cause corrosion oxidation on the insertion tube inside the instrument. There is a risk that the insertion tube may get stuck if this is allowed to happen.



Warning (all versions)

- **Never** leave hot insertion tubes that have been removed from the calibrator unsupervised – they may constitute a fire hazard or personal injury.

If you intend to store the calibrator in the optional protection carrying case after use, you **must** ensure that the instrument has cooled to a temperature **below 50°C/122°F** before placing it in the carrying case.

- **Never** place a hot insertion tube in the optional carrying case.
- **Do not** touch the well or insertion tube when these are deep frozen – they might create frostbite.

6.1.1 Transporting the dry-block calibrator



Caution...

The insertion tube **must** be removed to avoid damage to the instrument if the calibrator is to be transported long distances.

6.1.2 Transporting the liquid bath calibrator



Warning

Do not move the liquid bath calibrator containing hot fluid. When spilled the fluid might cause serious wounds. Before transporting the fluid it must be cooled down to a temperature near ambient.

When the fluid has cooled down it is possible to move the liquid bath calibrator by hand. The special designed lid must be used to reduce the risk of spilling.



Note...

Please be aware that the lid used for the RTC-158/250 instruments is not completely fluid tight. The oil might leak through the drainage hole in the lid. For the RTC-168 instrument, however, a fluid tight lid is available. The lid comes with a security valve, which, in case of overpressure, will let the air pass.



For any longer form of transportation the fluid **must** be removed (see section 6.2).

6.2 Emptying the well (liquid baths only)

It is not recommendable to leave the fluid in the well for long-term storage. The best way to store the fluid is in its original airtight container.



Caution – Hot surface

- **Do not** handle hot fluid.
- **Do not** attempt to remove hot fluid with the liquid drainage tube, as it might melt.
- **Do not** leave any fluid (silicone oil) in the spill tray.
- **Do not** touch the items removed from the well – they may be very hot and cause burns.

- **Never** leave hot items, which have been removed from the well, unsupervised – they may constitute a fire hazard or personal injury.

The following guidelines must be observed before emptying the well :

1. Switch off the calibrator using the power control switch.
2. Before handling the fluid, it must be cooled down to a temperature close to ambient.
3. Remove the sensor basket and clean it with disposable paper towels.
4. Remove the stirring magnet using the stirring magnet remover supplied and clean it with disposable paper towels (RTC-158 and RTC-250 only).
5. Empty the well using the liquid drainage tube supplied. Tilting the calibrator is not recommendable, as it increases the risk of splashing oil all over the test area.



Caution...

Avoid getting silicone oil on the clothes. It is impossible to wash off.

6. Any remaining oil in the well is cleaned up using disposable paper towels. It is recommendable to use the optional cleaning oil when cleaning the well



Warning

- **REMEMBER**, wear goggles when using the cleaning oil.
- **Do not** inhale vapours. Proper ventilation must be used.
- Product information on cleaning oil must be carefully investigated before use.

