



# Explorer™ Balances

## Instruction Manual



## Version History

Date	Version	Description
2025/6/1	A	<ul style="list-style-type: none"><li data-bbox="667 286 874 315">• Initial release</li></ul>
2025/9/26	B	<ul style="list-style-type: none"><li data-bbox="667 349 890 378">• Add accessory</li><li data-bbox="667 400 970 430">• Update specifications</li><li data-bbox="667 452 1050 481">• Update interface commands</li><li data-bbox="667 504 994 533">• Update span calibration</li><li data-bbox="667 555 1145 584">• Update preset user role accessibility</li></ul>

## TABLE OF CONTENTS

<b>1</b>	<b>INTRODUCTION.....</b>	<b>7</b>
1.1	Description.....	7
1.2	Features.....	7
1.2.1	Display.....	7
1.2.2	Digital Loadcell.....	7
1.2.3	Removable Draftshield Design.....	7
1.2.4	Digital Leveling Bubble.....	7
1.2.5	Status Lights.....	7
1.2.6	HID Data Transfer Function.....	7
1.2.7	Time Synchronization NTP (Network Time Protocol).....	7
<b>2</b>	<b>Safety Precautions.....</b>	<b>8</b>
2.1	Intended Use.....	8
2.2	Definition of Signal Warnings and Symbols.....	8
2.3	Safety Notes.....	8
<b>3</b>	<b>Installation.....</b>	<b>10</b>
3.1	Unpacking.....	10
3.2	Installing Components.....	10
3.2.1	For 0.01mg, 0.1mg, and 1mg Models.....	10
3.2.2	For 0.01g, and 0.1g Models.....	10
3.2.3	Selecting a Location.....	10
3.3	Connecting Power.....	11
3.4	Turn on the balance.....	11
3.4.1	Level the Balance Before Use.....	12
3.5	Remove Draftshield from the Base.....	13
3.6	Connecting the Interface.....	13
3.7	Overview of Parts and Features –Draft Shield Models.....	14
3.7.1	Side View.....	14
3.7.2	Rear View.....	14
3.7.3	Below Weighing Hook.....	15
3.8	Overview of Parts and Features –Non-Draft Shield Models.....	15
3.8.1	Side View.....	15
3.8.2	Rear View.....	15
3.9	Overview of Terminal.....	16
3.10	Main Screen Features.....	16
3.11	Warning and Notifications.....	17
3.11.1	Calibration Failure.....	17
3.11.2	Leveling Required.....	17

3.11.3	Password Expiration .....	17
3.12	Hotkeys .....	18
3.12.1	Standard Hotkeys .....	18
3.12.2	Additional Hotkeys (Add+) .....	19
3.13	Shortcut Buttons .....	19
3.14	HID Connections .....	19
3.14.1	English Keyboard .....	19
3.14.2	French Keyboard .....	20
<b>4</b>	<b>Weighing Application Modes .....</b>	<b>21</b>
4.1	Introduction .....	21
4.2	Basic Weighing .....	22
4.2.1	Weighing Result .....	22
4.2.2	Reference Fields – Basic Weighing .....	22
4.2.3	Item Setting .....	23
4.2.4	Minimum Weight .....	23
4.2.5	Set minimum weight value .....	24
4.2.6	Auto Tare .....	24
4.2.7	Sample Library .....	25
4.2.8	Printing Settings .....	25
4.2.9	Shortcut Buttons .....	25
4.3	Parts Counting .....	27
4.3.1	Application buttons .....	27
4.3.2	Begin Parts Counting .....	28
4.3.3	Accumulate the data for Parts Counting .....	28
4.3.4	Sample Library – Parts Counting .....	30
4.3.5	Printing Settings .....	30
4.4	Check Counting .....	31
4.4.1	Application buttons and Reference Field .....	31
4.4.2	Begin Check Counting .....	32
4.4.3	Accumulate the data for Check Counting .....	33
4.4.4	Sample Library – Check Counting .....	34
4.4.5	Printing Settings .....	35
4.5	Percent Weighing .....	35
4.5.1	Application buttons and Reference Field .....	35
4.5.2	Begin Percent Weighing .....	36
4.5.3	Accumulate the data for Percent Weighing .....	37
4.5.4	Sample Library – Check Counting .....	38
4.5.5	Printing Settings .....	38

4.6	Check Weighing.....	39
4.6.1	Reference Field.....	39
4.6.2	Begin Check Weighing.....	40
4.6.3	Sample Library – Check Weighing.....	41
4.6.4	Printing Settings.....	42
4.7	Dynamic Weighing.....	43
4.7.1	Application buttons.....	43
4.7.2	Begin Check Weighing.....	44
4.7.3	Sample Library – Dynamic Weighing.....	45
4.7.4	Printing Settings.....	45
4.8	Totalization.....	46
4.8.1	Application buttons.....	46
4.8.2	Begin Totalization.....	47
4.8.3	Accumulate the data for Totalization.....	47
4.8.4	Sample Library – Totalization.....	48
4.8.5	Printing Settings.....	48
4.9	Formulation.....	49
4.9.1	Application buttons.....	49
4.9.2	Begin Free Formulation.....	50
4.9.3	Begin Recipe Based Formulation.....	51
4.9.4	Printing Settings.....	52
4.10	Differential.....	53
4.10.1	Application Buttons.....	53
4.10.2	Begin Differential Weighing.....	54
4.10.3	Printing Settings.....	55
4.11	Peak Hold.....	56
4.11.1	Application Buttons/ Reference Field.....	56
4.11.2	Begin with Peak Hold.....	56
4.11.3	Begin with Display Hold.....	57
4.12	Density Determination.....	58
4.12.1	Application Buttons/ Reference Field.....	59
4.12.2	The Density Result Resolution.....	59
4.12.3	Begin Density Determination for Solid Material.....	60
4.12.4	Begin Density Determination for Porous Material.....	62
4.12.5	Begin Density Determination for Liquid Material.....	64
4.12.6	Sample Library – Density Determination.....	65
4.12.7	Printing Settings.....	65
4.12.8	Printing Settings.....	<b>Error! Bookmark not defined.</b>

<b>5</b>	<b>Menu Settings</b> .....	<b>66</b>
5.1	Menu Navigation.....	66
5.2	Menu Structure.....	66
5.3	Quick Setup.....	66
5.3.1	Language.....	66
5.3.2	Time Synchronization/ Network Server.....	67
5.3.3	Date and Time.....	67
5.3.4	Automatic Calibration.....	67
5.3.5	User Management.....	68
5.3.6	System Log.....	68
5.3.7	Balance Information.....	68
5.3.8	Digital Leveling.....	68
5.3.9	Repeatability Test.....	69
5.4	Calibration.....	70
5.4.1	Calibration Settings.....	71
5.4.2	Internal Calibration.....	71
5.4.3	Span Calibration.....	72
5.4.4	Calibration History.....	74
5.5	Balance Setup.....	74
5.5.1	Language.....	74
5.5.2	Time Synchronization/ Network Server.....	75
5.5.3	Date and Time.....	75
5.5.4	Balance Name.....	75
5.5.5	Change Password.....	75
5.5.6	Filter Level.....	75
5.5.7	Stability Indicator Range.....	76
5.5.8	Auto Zero Tracking.....	76
5.5.9	Gross Indicator.....	76
5.5.10	Graduation.....	76
5.5.11	Approved Mode.....	76
5.6	Sensor.....	77
5.7	System Log.....	78
5.8	ECO.....	78
5.8.1	Power Saving.....	79
5.8.2	Brightness.....	79
5.8.3	Volume.....	79
5.8.4	Status lights.....	79
5.9	User Management.....	79

5.9.1	Create, Edit Delete a User .....	80
5.9.2	Preset User Role Accessibility .....	80
5.9.3	Group User Permissions .....	81
5.9.4	Password Policy .....	81
5.10	Application Modes .....	81
5.11	Weighing Units .....	82
5.12	Communication .....	83
5.12.1	RS232 .....	84
5.12.2	RS232 (DB9) Pin Connections .....	85
5.12.3	Connections for the Label Printer .....	85
5.12.4	USB.....	85
5.12.5	Ethernet .....	86
5.12.6	WI-FI & Bluetooth .....	86
<b>6</b>	<b>Print Setting .....</b>	<b>88</b>
6.1	Print Content .....	88
6.2	Connect to Printer .....	89
6.3	Connect to PC.....	89
6.4	Data to Excel.....	90
6.5	Save to USB .....	91
6.5.1	Application Print Out Template .....	92
6.6	Printout Examples .....	95
6.6.1	Calibration Report Template .....	96
6.6.2	Batch Printing Output .....	97
<b>7</b>	<b>Library .....</b>	<b>98</b>
7.1	Library Data .....	98
7.2	Import and Export Library .....	99
<b>8</b>	<b>Maintenance.....</b>	<b>100</b>
8.1	Maintenance Menu .....	100
8.2	Software Upgrade .....	101
8.2.1	Software Upgrade Process .....	101
8.2.2	Balance Information .....	101
8.3	Service Menu .....	101
8.4	Service Log File .....	101
8.5	Factory Reset.....	102
8.6	Log Off .....	102
8.7	Power Off .....	102
<b>9</b>	<b>Legal For Trade Application.....</b>	<b>103</b>
9.1	Legal for Trade Setting .....	103

9.2	Balance Setting Changes .....	104
9.3	Verification .....	104
9.4	Sealing .....	105
9.5	Output Format.....	105
<b>10</b>	<b>MAINTENANCE.....</b>	<b>106</b>
10.1	Calibration .....	106
10.2	Cleaning .....	106
10.3	Troubleshooting .....	106
10.4	End of Life Instruction .....	106
10.4.1	Material Composition of 1mg, 0.1mg and 0.01mg Draftshield Models.....	107
10.5	Service Information .....	107
<b>11</b>	<b>TECHNICAL DATA.....</b>	<b>108</b>
11.1	Specifications.....	108
11.2	Model Specification Tables .....	109
11.3	Accessory Specifications .....	114
11.4	Drawings and Dimensions .....	115
11.5	Accessories.....	115
11.6	Interface Commands .....	117
<b>12</b>	<b>COMPLIANCE .....</b>	<b>117</b>
<b>13</b>	<b>LIMITED WARRANTY .....</b>	<b>123</b>



# 1 INTRODUCTION

## 1.1 Description

The new Explorer EXR series offers an intuitive interface, outstanding weighing performance, and an environmentally friendly design. The new generation Explorer establishes a groundbreaking standard for laboratory operations.

The Explorer EXR Balance is a highly accurate weighing balance, with proper care, it can offer over a decade of reliable service. It comes in various capacities, ranging from 120 grams to 12 kilograms.

## 1.2 Features

### 1.2.1 Display

The 7-inch display features vibrant colors and a glass panel that is easy to clean and protect chemical spills.

### 1.2.2 Digital Loadcell

The digital weighing cell offer the advantage of creating self-contained loadcell modules that perform all digital signal processing directly on the loadcell, and it leads to a high performance of the balance.

### 1.2.3 Removable Draftshield Design

Removable Draftshield for hassle-free cleaning and long-term care

### 1.2.4 Digital Leveling Bubble

The balances come with a digital-level bubble that guides users in adjusting the leveling feet.

### 1.2.5 Status Lights

Status lights for weighing visually indicate overload or underload behavior during the weighing process.

### 1.2.6 HID Data Transfer Function

Support for HID (Human Interface Device) connection to a computer without the need for drivers

### 1.2.7 Time Synchronization NTP (Network Time Protocol)

The NTP function enables users to synchronize the time for weighing data across the local network, ensuring consistency.

## 2 Safety Precautions

### 2.1 Intended Use

This instrument is intended for use in laboratories, pharmacies, schools, businesses and light industry. It must only be used for measuring the parameters described in these operating instructions. Any other type of use and operation beyond the limits of technical specifications, without written consent from OHAUS, is considered as not intended. This instrument complies with current industry standards and the recognized safety regulations; however, it can constitute a hazard in use. If the instrument is not used according to these operating instructions, the intended protection provided by the instrument may be impaired.

### 2.2 Definition of Signal Warnings and Symbols

Safety notes are marked with signal words and warning symbols. These show safety issues and warnings. Ignoring the safety notes may lead to personal injury, damage to the instrument, malfunctions and false results.

WARNING	For a hazardous situation with medium risk, possibly resulting in severe injuries or death if not avoided.
CAUTION	For a hazardous situation with low risk, resulting in damage to the device or the property or in loss of data, or minor or medium injuries if not avoided.
ATTENTION	For important information about the product. May lead to equipment damage if not avoided.
NOTE	For useful information about the product.

#### Warning Symbols



General hazard



Explosion hazard



Electrical shock hazard

### 2.3 Safety Notes



**CAUTION:** Read all safety warnings before installing, making connections, or servicing this equipment. Failure to comply with these warnings could result in personal injury and/or property damage. Retain all instructions for future reference.

- Before connecting power, verify that the AC adapter's input voltage range and plug type are compatible with the local AC mains power supply.
- Do not position the equipment such that it is difficult to reach the power connection.
- Make sure that the power cord does not pose a potential obstacle or tripping hazard.
- Operate the equipment only under ambient conditions specified in these instructions.
- This equipment is for indoor use only.
- Do not operate the equipment in wet, hazardous or unstable environments.
- Do not allow liquids to enter the equipment.
- Do not load the equipment above its rated capacity.
- Do not drop loads on the platform.
- Do not place the equipment upside down on the platform.
- Use only approved accessories and peripherals.
- Disconnect the equipment from the power supply when cleaning.
- Service should only be performed by authorized personnel.

- When shipping or transporting this product, follow the applicable regulations for equipment containing lithium-ion batteries.



**WARNING:** Never work in an environment subject to explosion hazards! The housing of the instrument is not gas tight. (Explosion hazard due to spark formation, corrosion caused by the ingress of gases).



**WARNING:** Electrical shock hazards exist within the housing! The housing should only be opened by authorized and qualified personnel. Remove all power connections to the unit before opening.



**CAUTION:** The protection provided by the unit may be impaired if used with accessories not provided or recommended by the manufacturer, or used in a manner not specified by the manufacturer.

## 3 Installation

### 3.1 Unpacking

Carefully unpack the Explorer EXR balance and its components. The components included may vary based on the balance model. Retain the packaging for safe storage and transportation.

- Balance
- Quick Start Guide
- Weighing Pan
- Power Adapter and Local Electronic Plug

### 3.2 Installing Components

The Explorer EXR balance is designed for quick, no-assembly installation, allowing for immediate use.

Simply follow the steps to assemble your balance within seconds.

Assembly of all components is required before using the balance.

#### 3.2.1 For 0.01mg, 0.1mg, and 1mg Models

Unpack the balance and install the weighing pan.

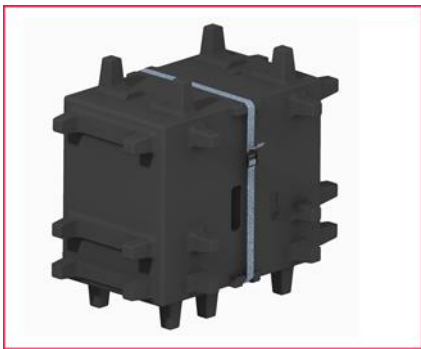

#### 3.2.2 For 0.01g, and 0.1g Models

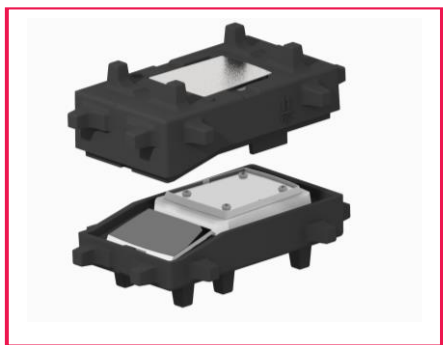
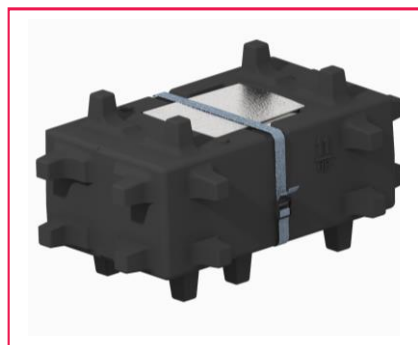

#### 3.2.3 Selecting a Location

External factors such as temperature fluctuations, air currents, electromagnetic interference, and vibrations can all have an impact on the accuracy of the analytical balance. It is important to keep the analytical balance in a controlled environment to minimize these factors and ensure accurate readings.



### 3.3 Connecting Power

- For Analytical and Precision models supplied with an AC adapter, connect the DC output connector to the power receptacle on the rear of the base. Then connect the AC power cord to a suitable electrical outlet.
- 



**Caution:**

- For use with CSA certified (or equivalent approved) power source, which must have a limited current output.
- Allow equipment to warm up for 60 minutes for optimal weighing performance.

### 3.4 Turn on the balance

Short press the power button to turn on the balance.



- Login the balance with default USERNAME AND PASSWORD.
  - USER ID: Admin
  - PASSWORD: No password required

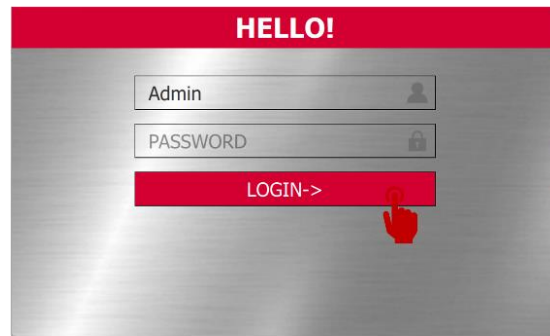

- When the balance run in sleep or standby or mode, press the LABMAN icon to start weighing.

### 3.4.1 Level the Balance Before Use

The Explorer EXR analytical and precision models are equipped with a digital level bubble. To level the balance, simply follow the provided steps. The digital level indicator will notify you if the weighing table is not level.

- If the environment is unstable or the weighing table is tilting too much, the leveling process may fail. In such cases, you need to move the balance to a stable, level surface that can absorb vibrations.
- Press the leveling button and adjust the leveling feet according to the position of the digital bubble until the bubble is centered.

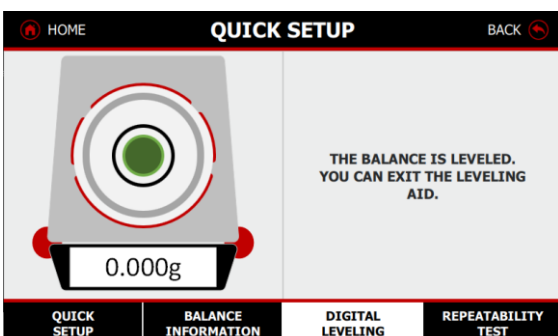
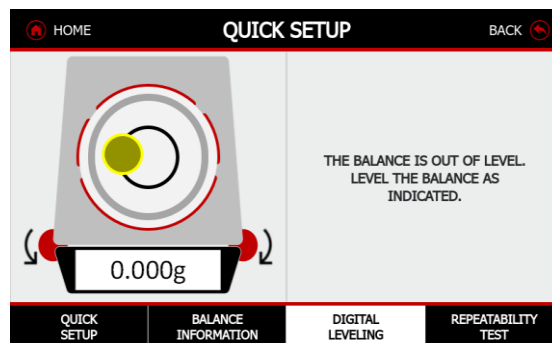
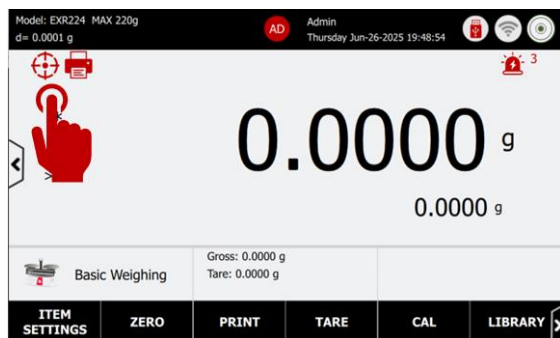

### 3.5 Remove Draftshield from the Base

- Remove the weighing pan and unlock the draft shield fixed ring.

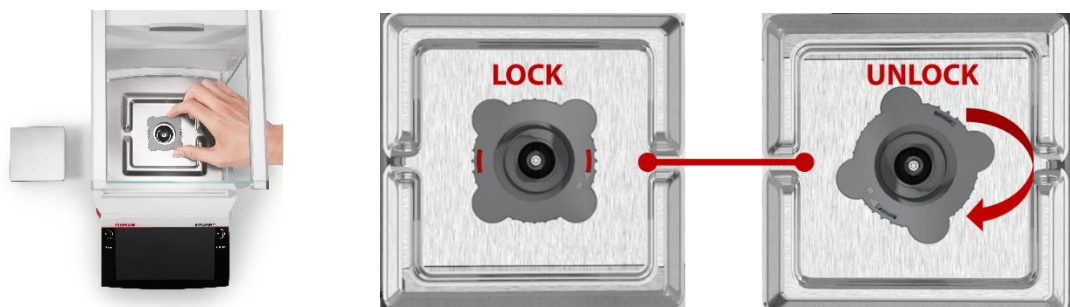

- Remove the EMC plate and take out the 4 screws beneath it. Raise the draft shield vertically.



### 3.6 Connecting the Interface

Enhanced communication options include 2 USB Host (Type A) x 2, USB Device (Type C) x 1, Ethernet Lan port (RJ45) x 1, RS232 x 1; Optional Wi-Fi, Bluetooth Dongle.



### 3.7 Overview of Parts and Features –Draft Shield Models

#### 3.7.1 Side View

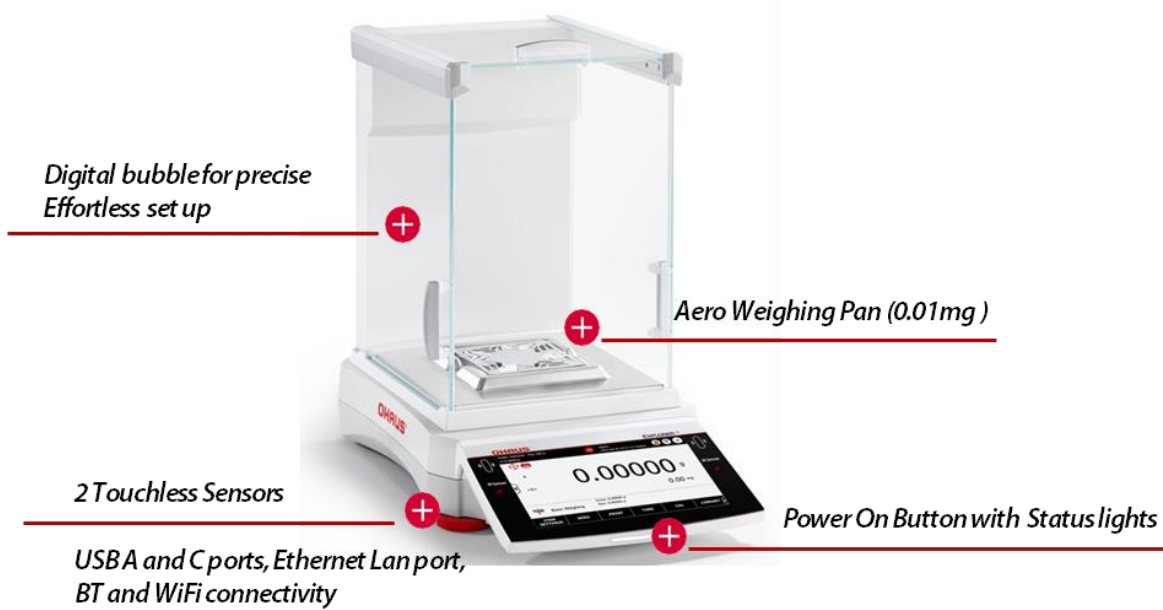

#### 3.7.2 Rear View

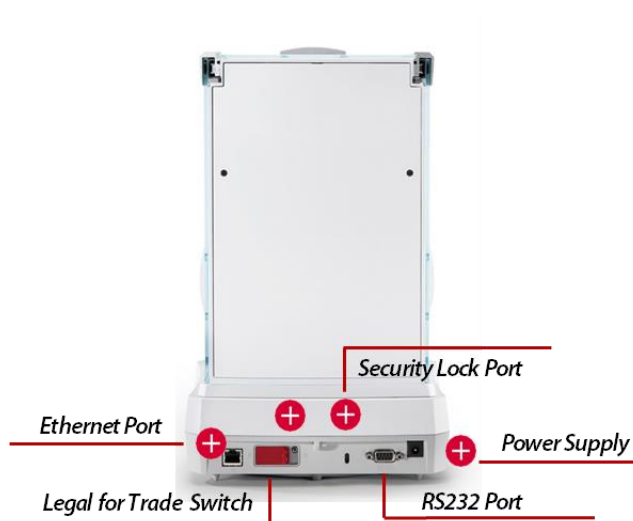



### 3.7.3 Weigh Below Hook



## 3.8 Overview of Parts and Features –Non-Draft Shield Models

### 3.8.1 Side View



### 3.8.2 Rear View



### 3.9 Overview of Terminal

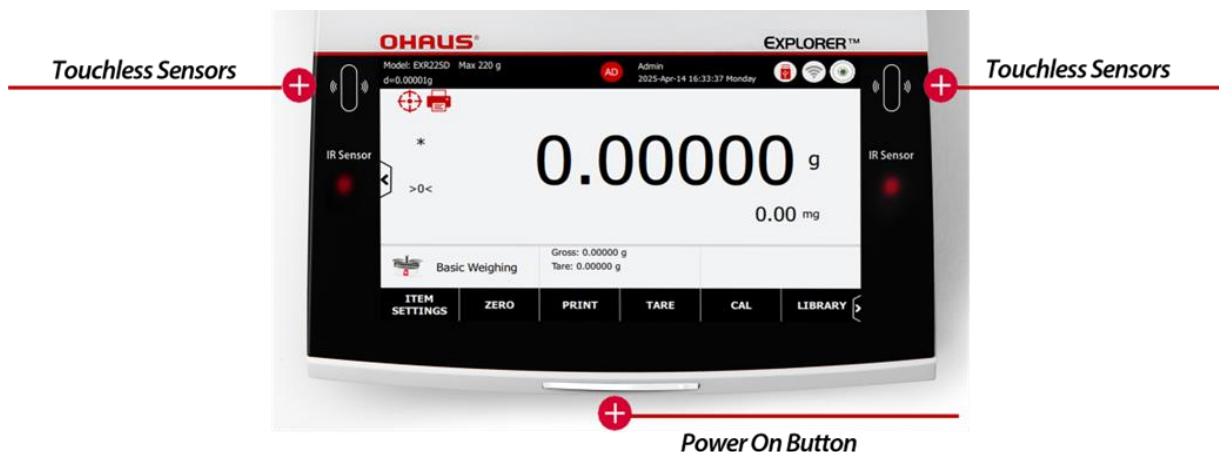

### 3.10 Main Screen Features

This Explorer EXR balance has built a 7-inch display features vibrant colors and a glass panel that is easy to clean and protect chemical spills.

<p><b>Upper Left (Shortcut buttons)</b></p> <ul style="list-style-type: none"> <li>✓ Leveling</li> <li>✓ Batch Print</li> </ul>	<p><b>Top Line</b></p> <ul style="list-style-type: none"> <li>✓ Display the essential balance information, such as model name, the max capacity, d value and e value.</li> <li>✓ User Name and Date/Time</li> </ul>	<p><b>Upper Right</b></p> <ul style="list-style-type: none"> <li>✓ Peripherals Icons connected to balance</li> <li>✓ Real time leveling bubble</li> <li>✓ Warning Sign</li> </ul>
<p><b>Press the trapezoidal key to switch between main menus.</b></p> <ul style="list-style-type: none"> <li>✓ Quick Setup</li> <li>✓ Calibration</li> <li>✓ Balance Setup</li> <li>✓ User Management</li> <li>✓ Application Modes</li> <li>✓ Weighing Units</li> <li>✓ Communication</li> <li>✓ Library</li> <li>✓ Maintenance</li> <li>✓ Factory Reset</li> <li>✓ Log Off</li> <li>✓ Power Off</li> </ul>	<p>The screenshot shows the main screen with a large display of '5.8787 g' and a smaller '5.8787 g' below it. The top line shows 'Model: EXR224 Max 220 g', 'd= 0.0001 g', 'Admin', and 'Monday Jun-30-2025 16:03:31'. The bottom menu includes 'ITEM SETTINGS', 'ZERO', 'PRINT', 'TARE', 'CAL', and 'LIBRARY 001'.</p>	<p><b>Main Display Area</b></p> <ul style="list-style-type: none"> <li>✓ Click “g” to switch an alternative unit</li> <li>✓ Display the parameter for the current application on the reference field</li> </ul>
<p><b>Press the “Basic Weighing” key to switch weighing application modes</b></p>	<p><b>Hotkeys</b></p> <ul style="list-style-type: none"> <li>✓ Item Settings, Zero, Print, Tare, Calibration, Library/Method, Sensors, and press “ADD+” key to add customized hotkeys</li> </ul>	<p><b>ADD+</b></p> <ul style="list-style-type: none"> <li>✓ 1d/10</li> <li>✓ Digital Leveling</li> <li>✓ Repeatability Test</li> </ul>

### 3.11 Warning and Notifications

The Explorer EXR balance features an internal warning and notification system that alerts users to take action in the following circumstances:

- Calibration failure: The balance has not calibrated successfully.
- Leveling required: The balance needs to be leveled when the digital level bubble is not centered.
- Password expiration: The password has expired in accordance with the password policy.

#### 3.11.1 Calibration Failure

- Press on the warning sign, and the notification will show up on the screen, press the message, you will find “Initial calibration” key.

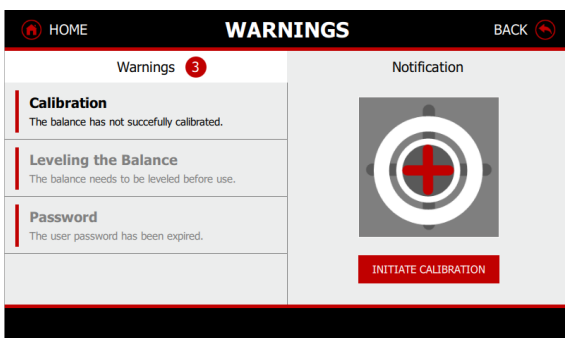

- Perform internal calibration or span calibration. Refer to Section 5.4 for detailed information on Calibration

#### 3.11.2 Leveling Required

- Press on the warning sign, and the notification will show up on the screen, press the message, you will find “Digital Leveling” key.

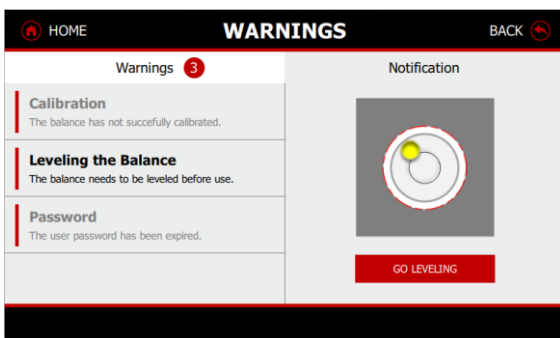

#### 3.11.3 Password Expiration

Press on the warning sign, and the notification will show up on the screen, press the message, you will find “Reset Password” key.

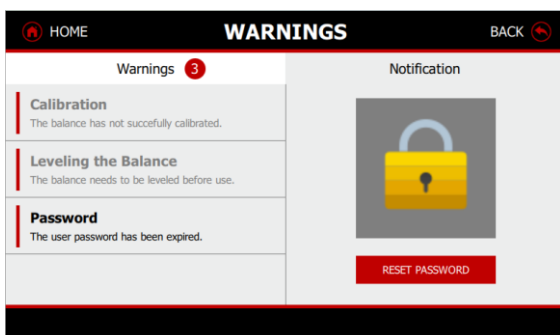

Note: If you forget your password, please contact Ohaus or your local Ohaus dealer for assistance.

## 3.12 Hotkeys

At the bottom of the main screen, there are eight hotkeys for basic weighing applications. Users can customize an additional five hotkeys by using the ADD+ feature.

### 3.12.1 Standard Hotkeys

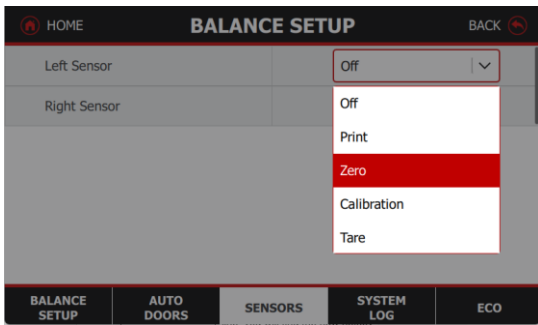
Hotkeys	Description
<b>Item Settings</b>	Press to configure current application mode settings.
<b>Zero</b>	Remove the load from the pan and press <b>Zero</b> to set the display to zero. When weighing pan is empty, the >0< indicator turns on when the measurement is within $\pm \frac{1}{4}$ division (d) of the zero setting.  <b>Note:</b> The balance also features Auto Zero Tracking (AZT) that automatically maintains a Center of Zero within the tolerances set in the AZT menu (see <b>Balance Setup</b> ).
<b>Print</b>	Press <b>Print</b> to send the displayed value to a printer or computer via the active COM port.  Make sure that the balance has connected with printer or PC and interface parameters are set up correctly.
<b>Tare</b>	Tare key is to tare the weight on the container to zero, and the net weight will show on the reference field
<b>CAL</b>	Press <b>CAL</b> to calibrate the balance or to set the calibration parameters.
<b>Library</b>	Press "Library" key to either create a new library or retrieve an existing one for the current application.
<b>Sensors</b>	<p>The balances have two pressless sensors that can be assigned a unique function when activated. The Sensor setting are: Off, Print, Zero, Calibration, and Tare</p>  <p>Once the sensor is set up for a specific function, waving your hand over it will trigger that function and cause the sensor light to turn green. If the sensor fails to activate, verify the settings. The sensor lights will remain red.</p>

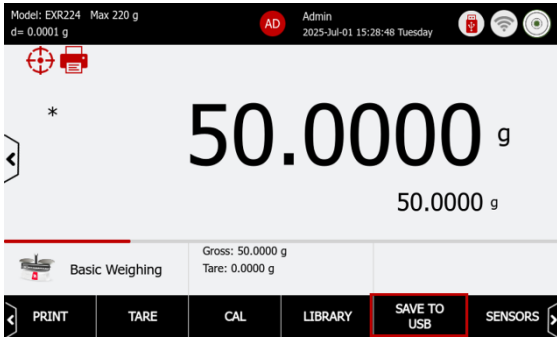
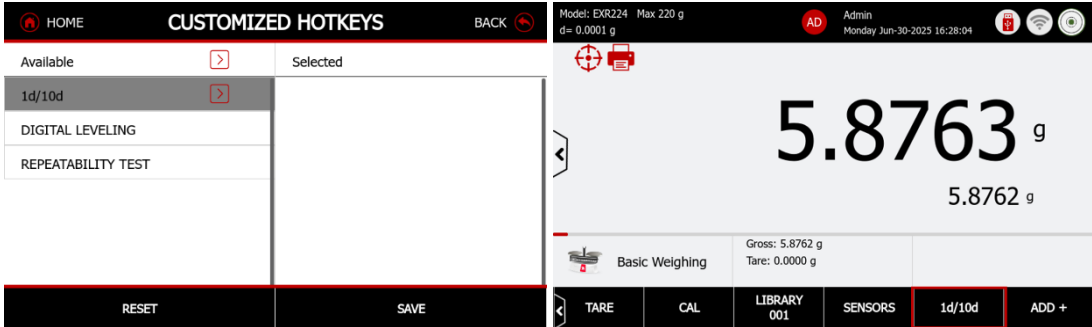
<p><b>Save to USB</b></p>	<p>When the user inserts the USB flash drive, an icon will appear on the right side of the Sensor. While data is being saved to the USB drive, the icon will display the progress.</p> <p>Do not unplug the USB drive during data transfer.</p> 
<p><b>Add+</b></p>	<p>Additional five hotkey to be customized.</p> <p>Click “Right Arrow” key to move the available hotkey to selected area and press “Save” to exit.</p> <p>The new hotkey will appear on the right side of the “Sensor” section. Swipe along the bottom line, you will find the new hotkey.</p> 

### 3.12.2 Additional Hotkeys (Add+)

<p>1d /10d</p>	<p>Press <b>1/10</b> to change 1d or 10d diviation for weighing result</p>
<p>Digital Leveling</p>	<p>Press to Leveling the balance</p>
<p>Repeatability Test</p>	<p>Press <b>Repeatability Test</b> to perform repeatability test</p>

## 3.13 Shortcut Buttons

The shortcut buttons are available only in Basic Weighing application. For details, please refer to shortcut button in section of 4.2.9

## 3.14 HID Connections

The Explorer EXR balance supports HID (Human Interface Device) connection to a computer without needing drivers. This allows users to use a mouse or keyboard to enter information such as User Name, USER ID, sample name, batch name, and other input details. The input field supports both English and French characters, as well as numbers, and symbols.

### 3.14.1 English Keyboard

- English keyboard is default setting, click “Upward arrow” key, you will find the lower-case letter and additional symbol such as @, %, -, ^ and etc.

- Repeat three times, and you can find all the characters you need to input.
- The currently selected language is displayed on the SPACE key.

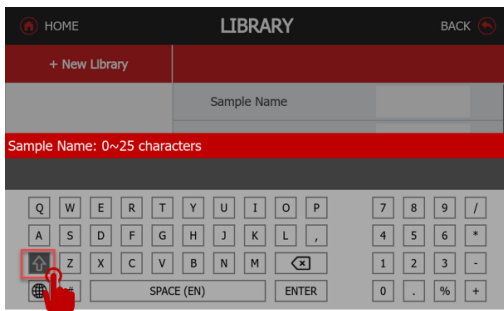

Uppercase Letter/ Numeric Input

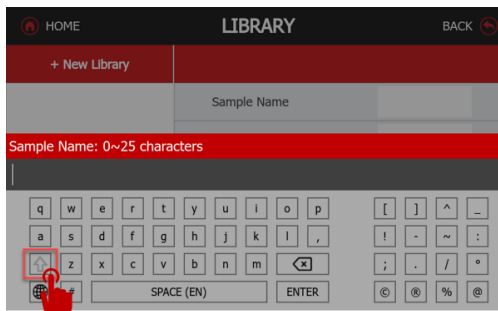

Lowercase Letter/ Symbol Input

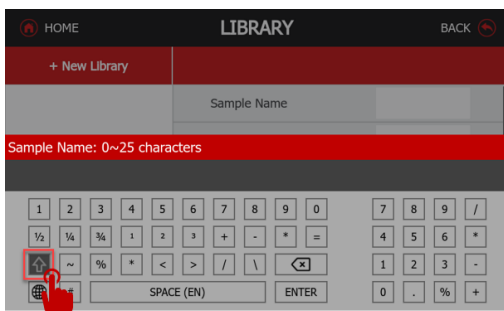

Numeric/ Symbol Input

### 3.14.2 French Keyboard

- Click “Earth” key, the keyboard changes to French language.
- Press the Upward arrow to access French characters, as well as symbols like %, 1/2, 1/4, 3/4, √2, ³3, ml, and more.
- Repeat three times, and you can find all the characters you need to input.
- The currently selected language is displayed on the SPACE key.

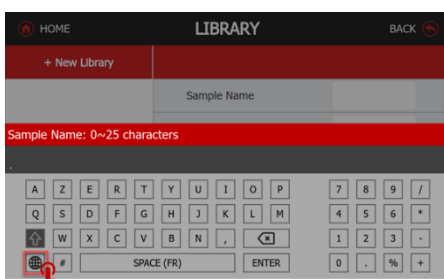

Uppercase Letter/ Numeric Input

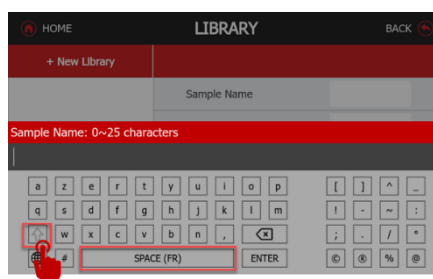

Lowercase Letter/ Symbol Input

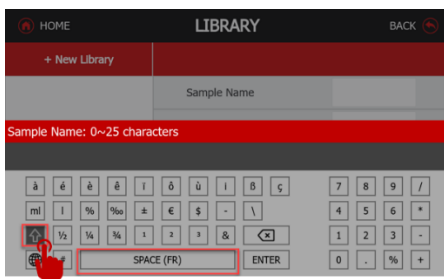

French character/ Number Input

## 4 Weighing Application Modes

### 4.1 Introduction

The Explorer EXR balance has 11 weighing application modes. All applications are by default enabled. You can disable the weighing application modes in Menu Menu/Application Modes. Before using any weighing application, ensure that the balance has been leveled and calibrated successfully

The application mode switch button is located in the lower left corner. Press the “Basic Weighing” key to switch weighing application modes.

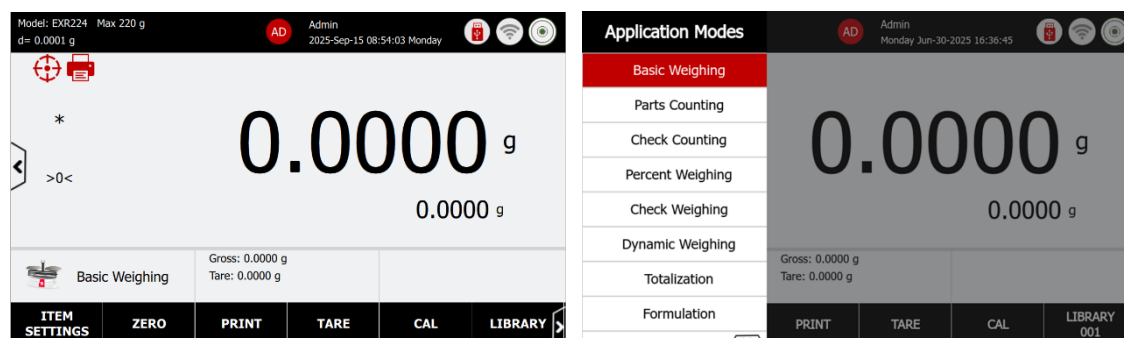

- **The Basic Weighing** application is used to determine the weight of items in the selected unit of measure.
- **Parts Counting** displays the number of pieces or parts based on an average piece weight. Checks if the current sample pieces are within tolerances (e.g. an over and under limit).
- **Check Counting** checks if the current sample pieces are within tolerances (e.g. an over and under limit).
- **Percent Weighing** displays the current weight as a percentage of a reference weight.
- **Check Weighing** checks if the current weight is within tolerances (e.g. an over and under limit).
- **Dynamic Weighing** is set to weigh objects that are not stable, such as animals.
- **Totalization** is used to sum the weights of multiple samples and report the statistical data for the series of samples.
- **Formulation** is used to combine various elements in proportionate amounts.
- **Differential** is used to calculate the difference in weights of multiple samples taken at different times.
- **Density Determination** is used to determines the density of a solid or a liquid.
- **Peak Hold** captures the maximum weight in a series of weighing.

## 4.2 Basic Weighing

- Basic weighing application modes are displayed by default on the main screen.
- Press **Tare** or **Zero** to start weighing.
- Place sample on the pan to display the weight. When stable, the \* appears.
- The resulting value is displayed in the main Weighing Line in the active unit of measure.

### 4.2.1 Weighing Result

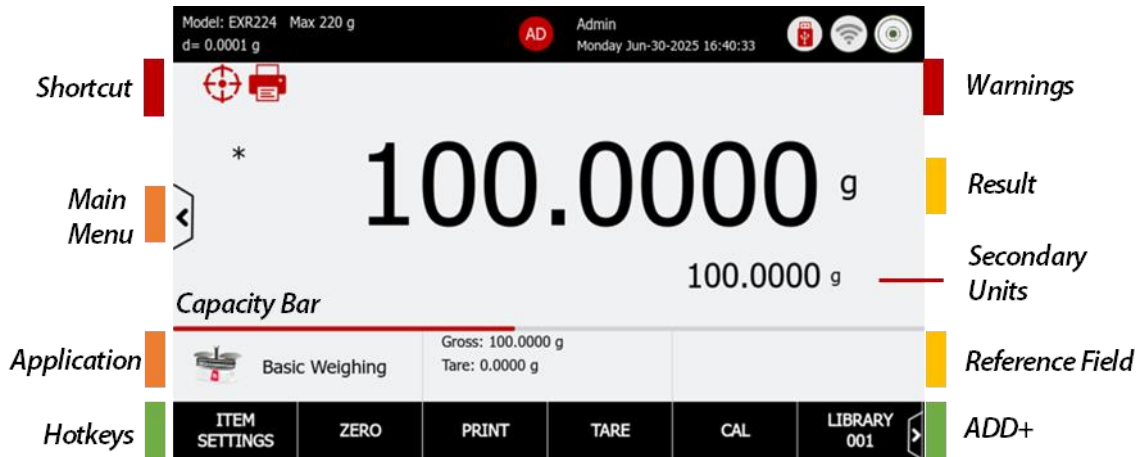

### 4.2.2 Reference Fields – Basic Weighing

Reference Fields	Description
Gross/ Tare	Display the Gross weight and tare value when the container is tared
Min Weight (Conditional)	When the Minimum Weight is set to On or Below Minimum Weight. Display the minimum weight value.
Capacity Bar	The red line represents the current load as a proportion of the balance maximum capacity.
Item Settings	<ul style="list-style-type: none"> <li>• Primary Weighing Unit: The default unit is grams. The operator can switch to alternative weighing units and two custom units.</li> <li>• Secondary Weighing Unit: able to alternative weighing units and 2 custom units</li> <li>• Weighing Mode: Standard, Sample Dosing Mode                             <ul style="list-style-type: none"> <li>■ Sample Dosing Mode is designed for powder sample, or any sample are sensitive to be stable</li> </ul> </li> <li>• Minimum Weighing</li> <li>• Auto Tare: Automatic tare the container value</li> </ul>



### 4.2.3 Item Setting

Press the ITEM SETTINGS button to change the application settings.

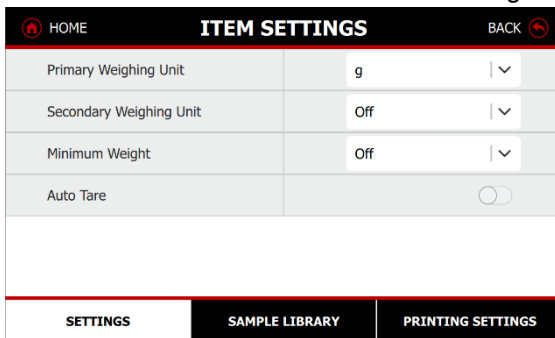

#### Primary Weighing Unit/ Secondary Weighing Unit

- Click “g” to switch an alternative primary weighing unit. The default unit is gram.
- Select a secondary unit to display below the primary line.

#### Switch to alternative Unit

Click “g” to switch an alternative unit

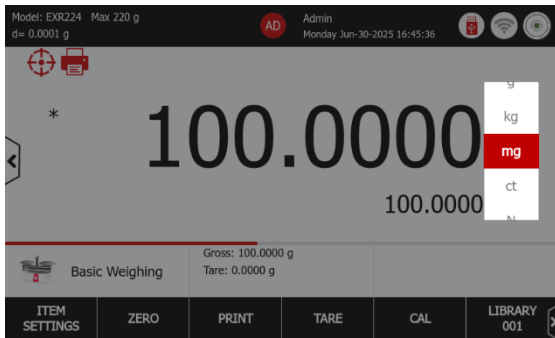

### 4.2.4 Minimum Weight

Determining the minimum weight in laboratories is crucial for ensuring accurate and reliable weighing results. The Explorer EXR balance has the min-weight function that the user has already get the result of the manual weight from repeatability test. In the basic weighing, user can input the known min-weight in this balance. When the result is lower than min-weight, the screen will show “Below Minimum Weight”, and the operator has to add more samples.

The Explorer EXR balance offers three options of minimum weight settings: Off, On, and Below Minimum Weight.

- **Off:** Disable function
- **On:** When the result is lower than min-weight, the screen will show “Below Minimum Weight”.
  - The operator had to add more samples. The result will not be printed in paper printouts.

- **Below Minimum Weight:** When the result is lower than min-weight, the screen will show “Below Minimum Weight”. The operator had to add more samples. The result will be printed in paper printouts.
- **Example:** If the minimum weight is set at 10 g and the sample weighs 5.8776 g, the screen will display “Below Minimum Weight.” Once additional samples are added and the weight reaches the min-weight standard, the screen will then show the standard weight.

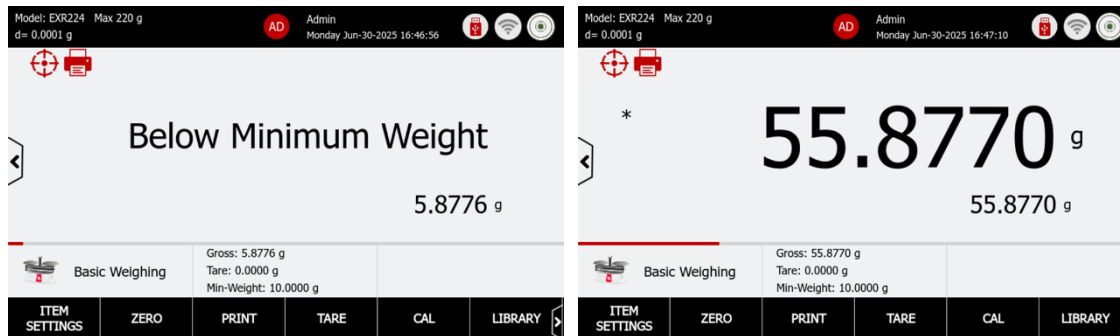

### 4.2.5 Setting the minimum weight value

- Press to the Sample Library tab to input the min-weight value when you turn on the min-weight in settings.
- Input the min-weight value, and the range of minimum weight is from 0g to max capacity. If the number is out of the range, it will display an error message “invalid entry”.

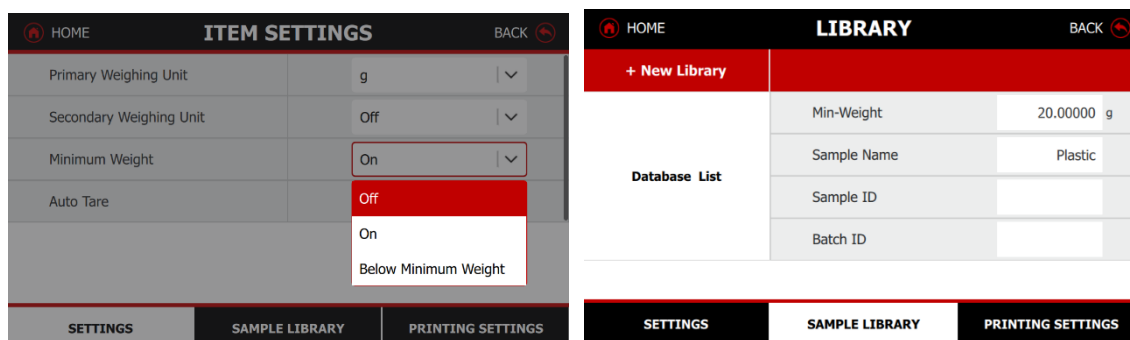

### 4.2.6 Auto Tare

- Auto tare allows users to tare the container weight
- When Auto Tare is enabled, the screen would display the message “Place container on the pan.”
- After a container is placed on the weighing pan, its weight will be stored in the balance. The net weight and gross weight values will then be displayed in the reference field.

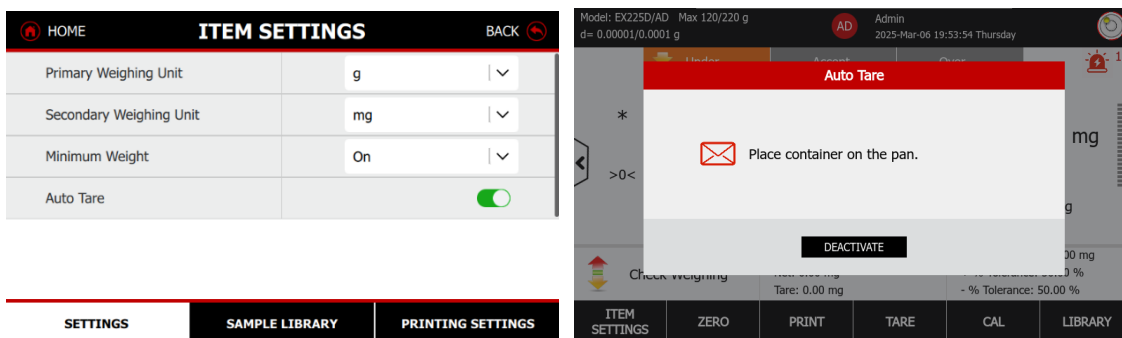

### 4.2.7 Sample Library

The Explorer EXR balance features a built-in library for managing multiple sample profiles. Up to 1,000 library records can be saved and recalled for use. The total library capacity and records are accessible across various application modes and through the library menu. When the library usage exceeds 80%, a pop-up message will alert the user to export the library or delete all items. The entire library menu, please refer to the section of Library.

#### Create, Activate and Delete a Library

- Press “+New Library” button to create a new Library.
- When a new library is created, it remains inactive. The operator has to activate the library after ticking the box.
- Press on the RUBISH BIN button to delete a library.
- After the library item is activated, the main screen will show the activated library number.
- Other sample information can be configured in the library, including sample name, sample ID, batch ID, lot ID, project ID, and the creation of 10 more customized ID.

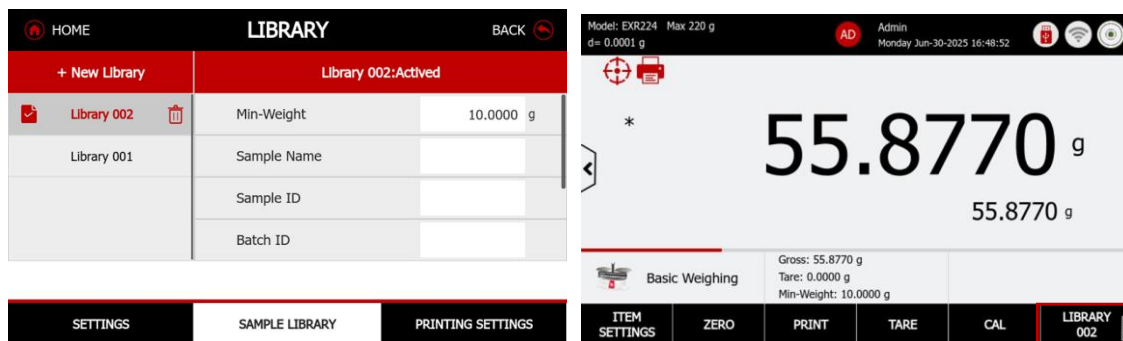

### 4.2.8 Print Settings

The Explorer EXR balance offers advanced print settings. Users can customize the output format and content and direct it to Excel or save it in a USB-compatible format. Additionally, users can review the print content to ensure all items are correctly selected before printing on paper or PC.

For details of Print Settings, please refer to section 6.0.

### 4.2.9 Shortcut Buttons

The Explorer EXR balance offers three shortcut buttons for easy leveling, and print batch sample result.

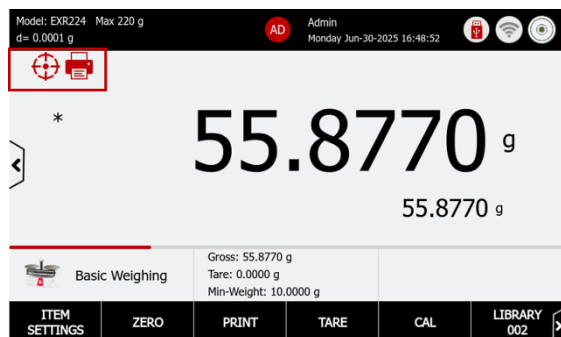

#### Digital Leveling

Press the leveling button and adjust the leveling feet according to the position of the digital bubble until the bubble is centered. See detail in section of leveling in Quick Setup 5.3.

**Batch Printing**

Batch Printing enables users to record and print a list of sample weights, with the capacity to handle up to 99 sample units in a single batch. This feature is exclusive to the Basic Weight application.

- Press the button to start measure batch samples. The batch sample information will show on the left side of screen. The right side of screen shows the current sample result.
- Place a sample onto the weighing pan, press accept when the weight is stable.
- Press “End Batch” button to complete the sample batch weighing, then the operator can print all the batch weighing data in once.
- Before printing, the user can go back to edit when the result has errors.
- User can export the data to PDF or print to PC/ Printer. After printing, operator can review the history result
  - The batch printing printout is detailed in Section 6.6 under Printout Examples.

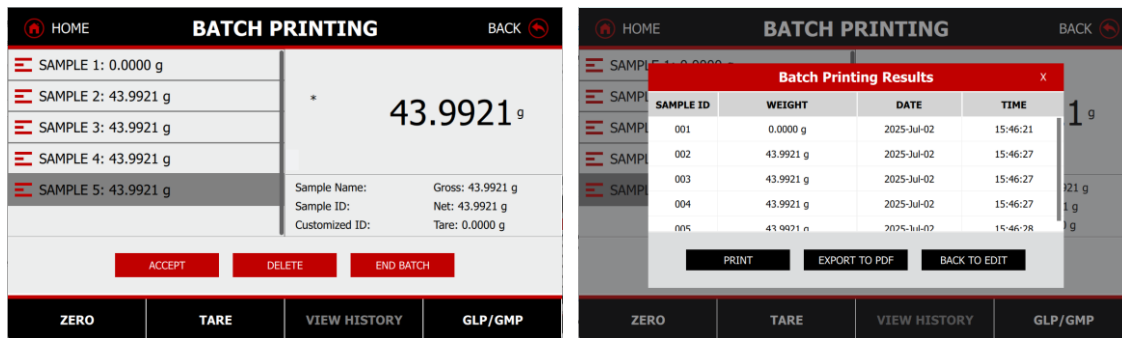

- The user can edit GLP/GMP sample information in the last tab, press save button before exit

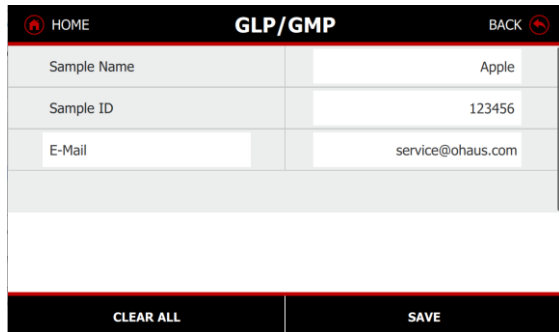

**Notes:**

- The batch printing value can start from 0 g in the batch weighing process.
- If users would like to continue with batch printing, tap "BACK TO EDIT" to exit the result screen. The result will neither be printed nor saved to the history.

### 4.3 Parts Counting

- Use this application to count samples of uniform weight.
- In the lower portion of the home screen, select Parts Counting.
- Press **Tare** or **Zero** to start weighing.
- Place objects on the pan to display the number of pieces. The default (or last) Average Piece Weight (APW) is displayed.
- Setup the SAMPLE SIZE, Average Piece Weight (APW) before starting Parts Counting application.

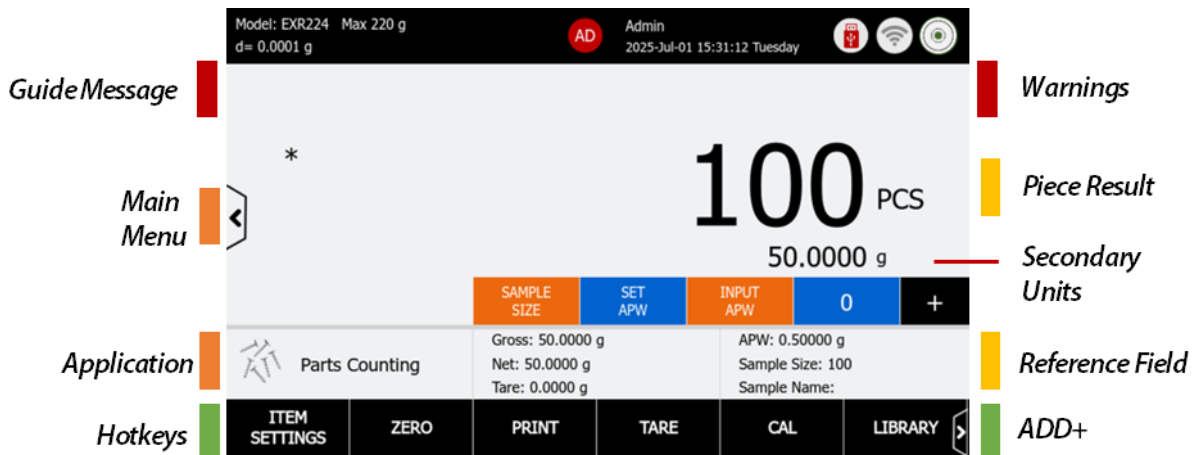

#### 4.3.1 Application buttons

Application Button	Description
Sample Size	Input sample size
Set APW	Place the sample on the pan, the balance will calculate Average Piece Weight (APW)
Input APW	Input Average Piece Weight (APW)
0	The statistic key is to recall the number of parts counting, and press this button, operator can review the statics results.
+	Press this button to manually accumulate weight. In Automatic Statistics mode, this button will be inactive.
Item Settings	<ul style="list-style-type: none"> <li>• Auto Optimization: able to automatically optimized APW Auto Optimization improves counting accuracy.</li> <li>• Statistics: Automatic, Manual</li> <li>• Secondary Weighing Units: able to use 15 weighing units and 2 customer units</li> <li>• Auto Tare: Automatic tare the container value</li> </ul>

### 4.3.2 Begin Parts Counting

#### Step 1: Establish an Average Piece Weight (APW)

Each time a new type of part is counted, the nominal weight of one piece (Average Piece Weight or APW) must be established using a small quantity of pieces.

#### Set a Known Average Piece Weight (APW)

- Press the INPUT APW button and enter the desired APW value.
- Tap ENTER to save the value

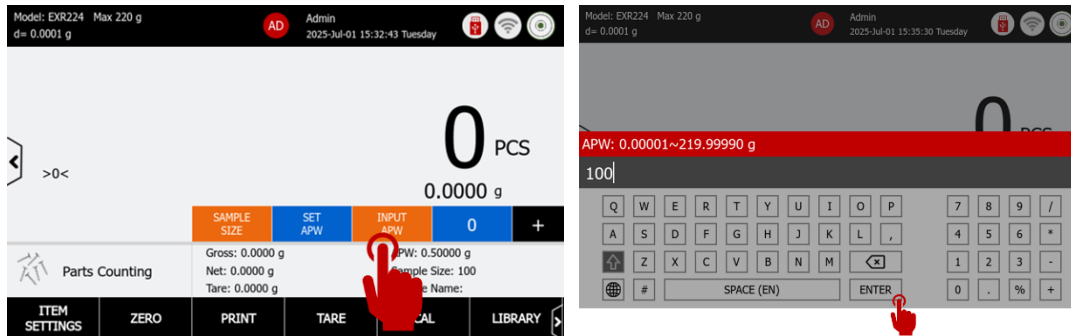

#### Set a new Average Piece Weight (APW) – Derived

- Press the Sample Size button and enter the desired Sample Size.
- Tap ENTER to save the value
- Place reference weight on the pan, and press Accept to establish a new APW.
- Example: The home screen displays 0.5 g at the new APW.

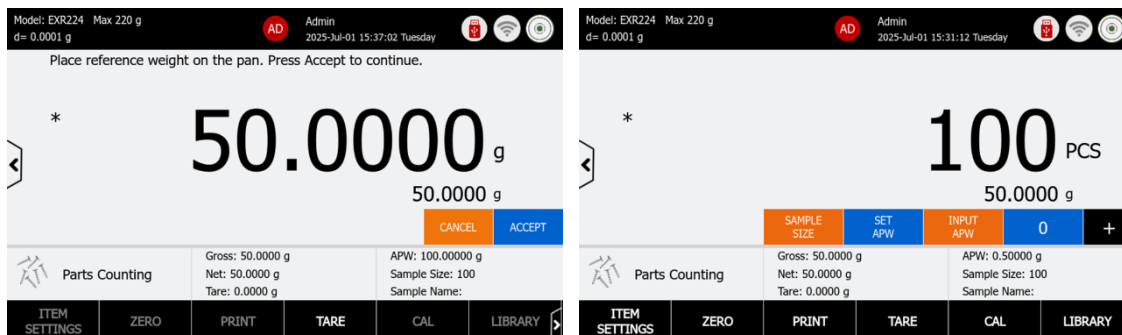

- The sample size can be 1 to 10 000 pieces. The default sample size is 10.
- Once a sample size is changed, the balance will immediately recalculate APW screen, expecting to establish a new APW. The home screen shows 100 pieces at the new APW

#### Step 2: Counting the Samples

Place samples on the pan, the balance will display the number of pieces.

### 4.3.3 Accumulate the data for Parts Counting

Utilize the Statistics "+" function to aggregate samples based on counting numbers and generate statistical reports.

The balance can store up to 99 accumulation records.

#### Step 1: Set the Statistic Mode in Parts Counting Mode

- Statistics can be determined Manual mode or automatically
- Automatic Mode: Weights are automatically recorded when stable
- To use the statistics function, enable it first in the Item Settings.
- Add items and press the "+" Statistic button to accumulate the statistical data

- Tap the statistics number to view the statistical results.

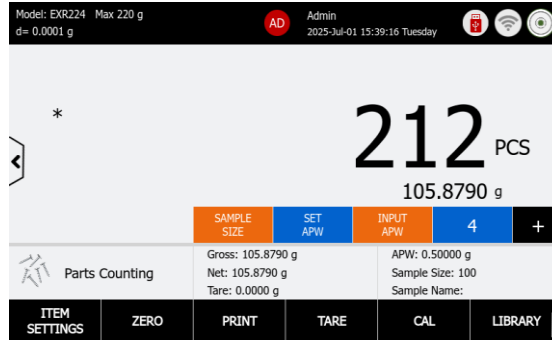
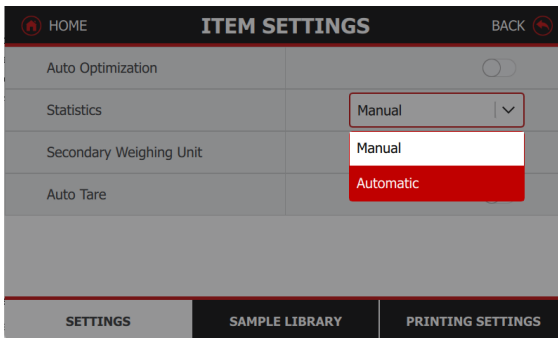

**Step 2: Statistics Report View**

- The report content includes Start Time, Number of Samples, Total, Average, Maximum, Minimum, Range, Standard Deviation, Relative Deviation % and individual item weighing values.

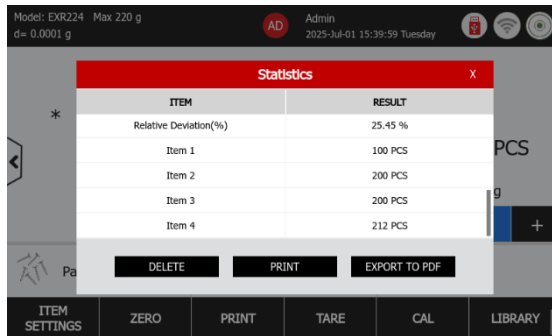
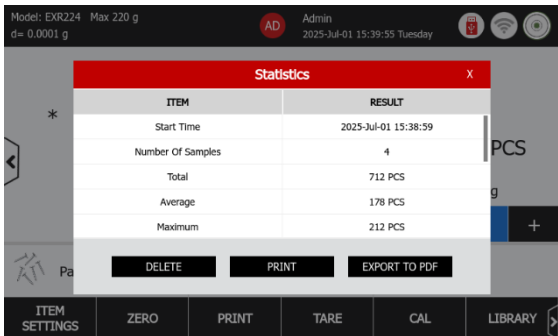

**Step 3: Print Report**

After reviewing the report, users can choose from several actions:

- Delete the statistics and restart the percent weighing process
- Print the report to a printer or PC based on the Print Settings
- Export the report as a PDF file to a USB flash drive

### 4.3.4 Sample Library – Parts Counting

The Explorer EXR balance features a built-in library for managing multiple sample profiles. Up to 1,000 library records can be saved and recalled for use. The total library capacity and records are accessible across various application modes and through the library menu. When the library usage exceeds 80%, a pop-up message will alert the user to export the library or delete all items. The entire library menu, please refer to section 7.0.

#### Create, Activate and Delete a Library

- Press “+New Library” button to create a new Library.
- When a new library is created, it remains inactive. The operator has to activate the library after ticking the box.
- Press on the RUBISH BIN button to delete a library.

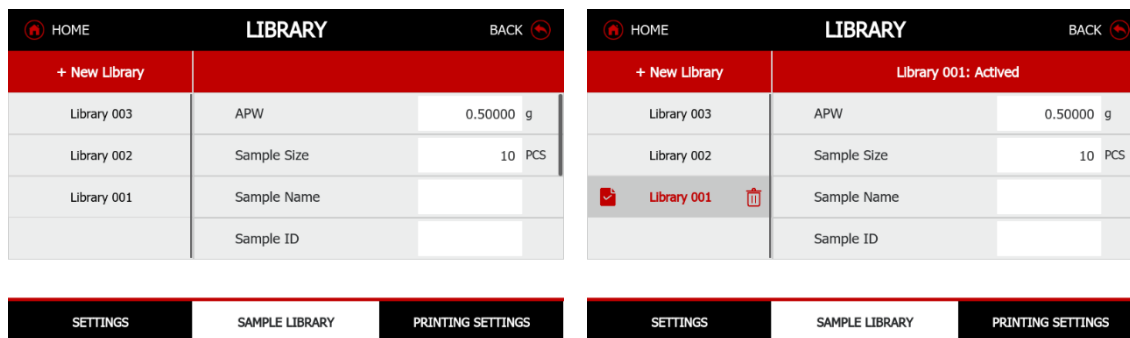

- After the library item is activated, the main screen will show the activated library number.

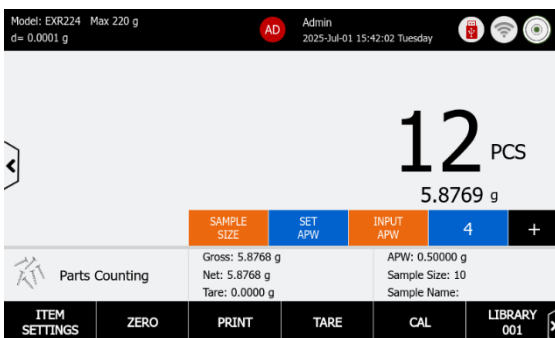

- Other sample information can be configured in the library, including sample name, sample ID, batch ID, lot ID, project ID, and the creation of 10 more customized ID.

### 4.3.5 Printing Settings

The Explorer EXR balance offers advanced print settings. Users can customize the output format, and content and direct it to Excel or save it in a USB-compatible format. Additionally, users can review the print content to ensure all items are correctly selected before printing on paper or PC.

For details of Printing Setting, please refer to section 6.0.



## 4.4 Check Counting

- Use this application to check if the current sample pieces are within tolerances (e.g. an over and under limit).
- In the lower portion of the home screen, select Check Counting.
- Press **Tare** or **Zero** to start weighing.
- Place objects on the pan to check if the number of pieces are within the tolerances. The default over and under limit pieces is displayed.
- Setup the SAMPLE SIZE, Average Piece Weight (APW) before starting Check Counting application.

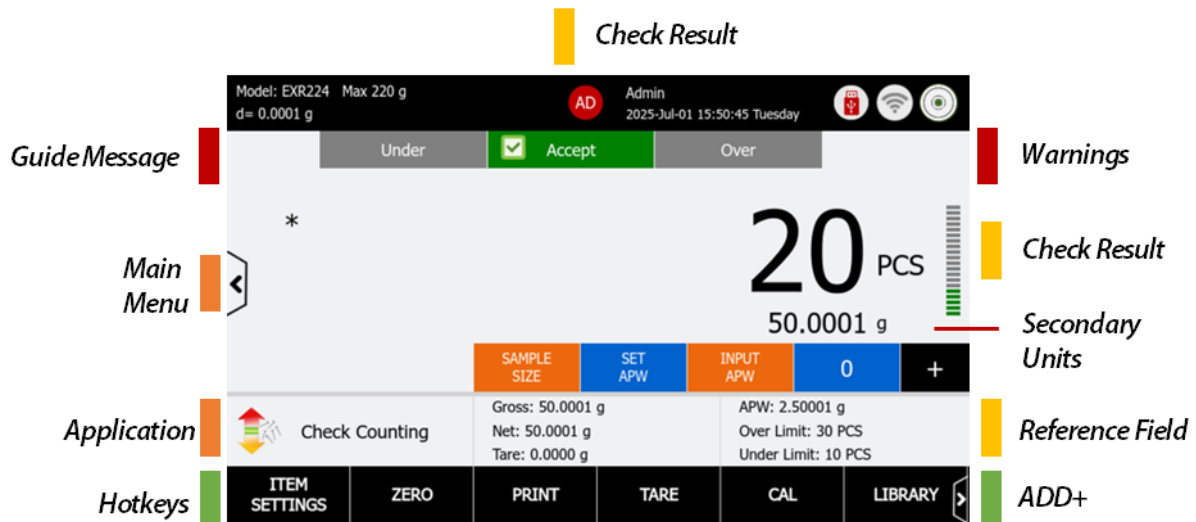

### 4.4.1 Application buttons and Reference Field

Application buttons/ Reference Field	Description
<b>Sample Size</b>	Input sample size
<b>Set APW</b>	Place the sample on the pan, the balance will calculate Average Piece Weight (APW)
<b>Input APW</b>	Input Average Piece Weight (APW)
<b>0</b>	The statistic key is to recall the number of check counting, and press this button, operator can review the statics results.
<b>+</b>	Press this button to manually accumulate weight. In Automatic Statistics mode, this button will be inactive.
<b>Item Settings</b>	<ul style="list-style-type: none"> <li>• Auto Optimization: able to automatically optimized APW Auto Optimization improves counting accuracy.</li> <li>• Statistics: Automatic, Manual</li> <li>• Secondary Weighing Units: able to use 15 weighing units and 2 customer units</li> <li>• Audible Signal: The balance beeper will sound to alert the user of the check status.</li> </ul>

	<ul style="list-style-type: none"> <li>Available Setting: Off, Under, Accept, Over, Under and Over</li> <li>Auto Tare: Automatic tare the container value</li> </ul>
<p><b>Check Status</b></p> 	<ul style="list-style-type: none"> <li><b>Under</b>-Orange indicator</li> <li><b>Accept</b>-Green Indicator</li> <li><b>Over</b>-Red Indicator</li> <li>The check status is divided into 20 segments to display the proportion of the current load relative to the total capacity. Each segment corresponds to 5% of the total capacity.</li> </ul>
<p><b>Status Lights</b></p>	<ul style="list-style-type: none"> <li>If the check status is either <b>Under</b> or <b>Over</b>, the lights will turn red to indicate this.</li> </ul>
<p><b>Over Limit</b></p>	<ul style="list-style-type: none"> <li>The piece value exceeds the maximum allowed threshold.</li> </ul>
<p><b>Under Limit</b></p>	<ul style="list-style-type: none"> <li>The piece value exceeds the maximum allowed threshold.</li> </ul>

### 4.4.2 Begin Check Counting

#### Step 1: Establish an Average Piece Weight (APW)

Each time a new type of part is counted, the nominal weight of one piece (Average Piece Weight or APW) must be established using a small quantity of pieces.

#### Set a Known Average Piece Weight (APW)

- Press the INPUT APW button and enter the desired APW value.
- Tap ENTER to save the value

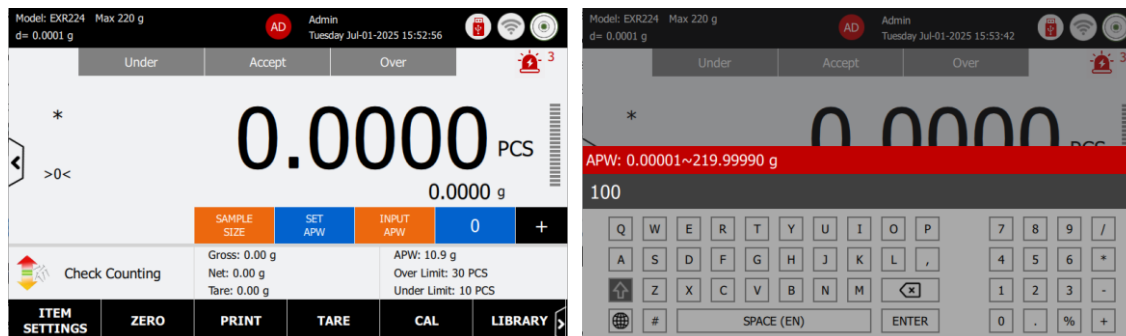

#### Set a new Average Piece Weight (APW) – Derived

- Press the Sample Size button and enter the desired Sample Size.
- Tap ENTER to save the value
- Place reference weight on the pan, and press Accept to establish a new APW.
- The sample size can be 1 to 10 000 pieces. The default sample size is 10.
- Once a sample size is changed, the balance will immediately recalculate APW screen, expecting to establish a new APW.
- Example: The home screen displays 5.00000 g as the new APW.

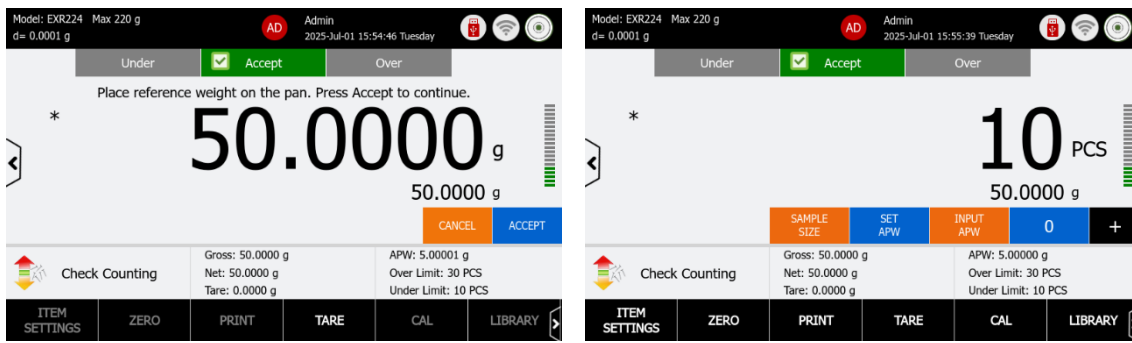

**Step 2: Establish Over Limit and Under Limit and check the result**

- The Over Limit and Under Limit are set in Library.
- The main screen will display the check status of the current sample in the library.
  - If the check status is either Under or Over, the lights will turn red to indicate this.
  - When the piece value exceeds the over limits, the screen will display Over.
  - When the piece value exceeds the under limits, the screen will display Under.
  - When the piece value is in the accept range, the screen will display Accept.
- Example: The home screen shows 30 pieces at the **Accept Range**.

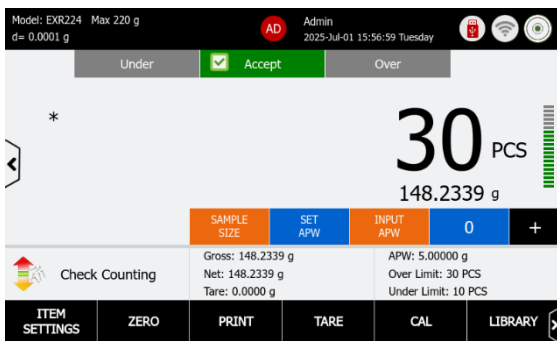

**4.4.3 Accumulate the data for Check Counting**

Utilize the Statistics "+" function to aggregate samples based on counting numbers and generate statistical reports.

The balance can store up to 99 accumulation records.

**Step 1: Set the Statistic Mode in Parts Counting Mode**

- Statistics can be determined Manual mode or automatically
- Automatic Mode: Weights are automatically recorded when stable

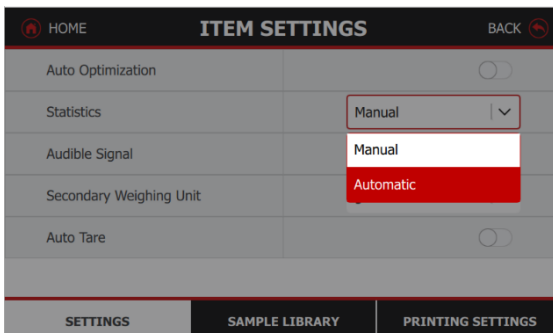

**Step 2: Statistics Report View**

- To use the statistics function, enable it first in the Item Settings.
- Add items and press the “+ Statistic button to accumulate the statistical data
- Tap the statistics number to view the statistical results.
- Statistics Report View
  - The report content includes Start Time, Number of Samples, Total, Average, Maximum, Minimum, Range, Standard Deviation, Relative Deviation % and individual item weighing values.

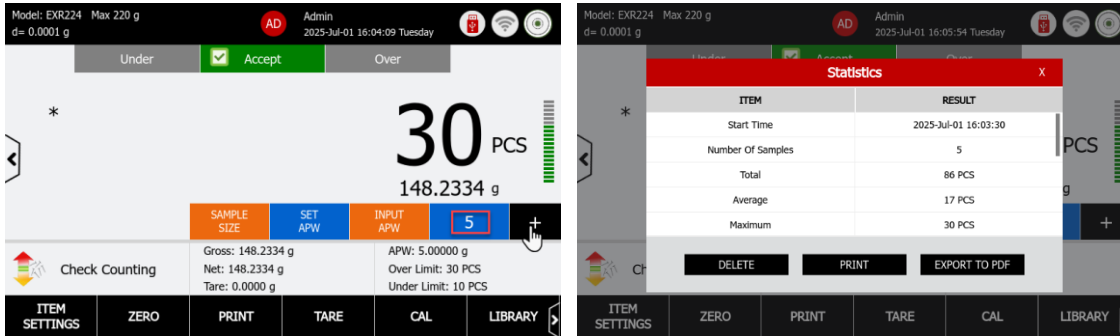

**Step 3: Print Report**

After reviewing the report, users can choose from several actions:

- Delete the statistics and restart the percent weighing process
- Print the report to a printer or PC based on the Print Settings
- Export the report as a PDF file to a USB flash drive

**4.4.4 Sample Library – Check Counting**

The Explorer EXR balance features a built-in library for managing multiple sample profiles. Up to 1,000 library records can be saved and recalled for use. The total library capacity and records are accessible across various application modes and through the library menu. When the library usage exceeds 80%, a pop-up message will alert the user to export the library or delete all items. The entire library menu, please refer to section 7.0.

**Create, Activate and Delete a Library**

- Press “+New Library” button to create a new Library.
- When a new library is created, it remains inactive. The operator has to activate the library after ticking the box.
- Press on the RUBISH BIN button to delete a library.
- After the library item is activated, the main screen will show the activated library number.
- Other sample information can be configured in the library, including sample name, sample ID, batch ID, lot ID, project ID, and the creation of 10 more customized ID.

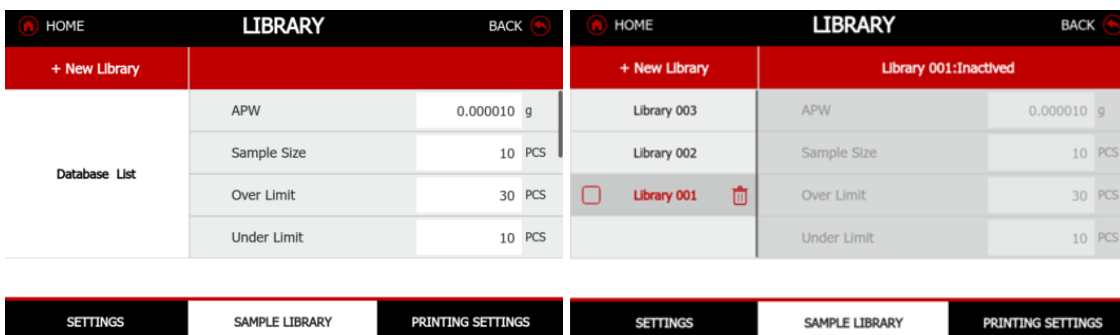

### 4.4.5 Print Settings

The Explorer EXR balance offers advanced print settings. Users can customize the output format and content and direct it to Excel or save it in a USB-compatible format. Additionally, users can review the print content to ensure all items are correctly selected before printing on paper or PC.

For details of Print Settings, please refer to section 6.0.

## 4.5 Percent Weighing

Use this application to displays the current weight as a percentage of a reference weight.

- In the lower portion of the home screen, select Percent Weighing.
- Place objects on the pan to display the percentage of a reference weight.
- Press **Tare** or **Zero** to start weighing.
- The default Reference weight is displayed.
- Setup the Reference Weight, Reference Adjust or Set Reference Weight before starting Percent Weighing application.

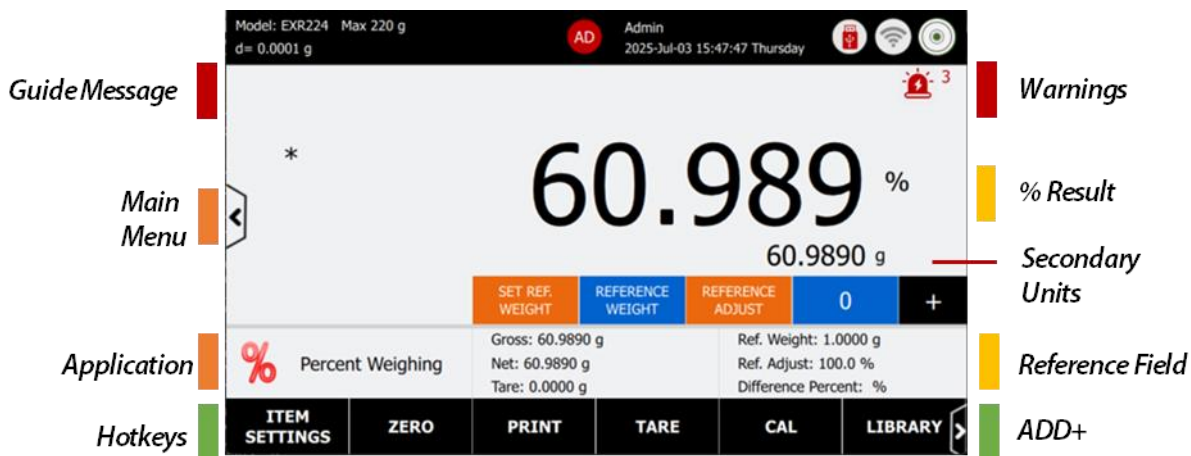

### 4.5.1 Application buttons and Reference Field

Application Button/ Reference Field	Description
<b>Reference Weight</b>	In manufacturing or quality control processes, a reference weight can be used to verify that products meet specified weight standards. The reference weight can be set within the range of 100d to the maximum capacity.
<b>Reference Adjust</b>	Reference adjust is a known value used to adjust the Reference Weight
<b>Set Ref. Weight</b>	Place the sample on the pan, the balance will store the reference weight.
<b>0</b>	The statistic key is to recall the number of percent weighing, and press this button, operator can review the statics results.

<b>+</b>	Press this button to manually accumulate weight. In Automatic Statistics mode, this button will be inactive.
<b>Item Settings</b>	<ul style="list-style-type: none"> <li>Statistics: Automatic, Manual</li> <li>Secondary Weighing Units: able to use 15 weighing units and 2 customer units</li> <li>Auto Tare: Automatic tare the container value</li> </ul>
<b>Ref. Factor</b>	<ul style="list-style-type: none"> <li>It displays the percentage of the current reference weight, with the unit in %, accurate to one decimal place.</li> </ul>
<b>Diff. Factor</b>	<ul style="list-style-type: none"> <li>It displays the percentage difference between the sample weight and the predetermined reference weight in weighing calculations.</li> <li>The unit is %, accurate to two decimal places.</li> </ul>

### 4.5.2 Begin Percent Weighing

#### Set a Known Reference Weight

- Press the REFERENCE WEIGHT button and enter the desired Reference Weight value.
- Tap ENTER to save the value
- Example: The home screen displays 50.0000 g as the Reference Weight.

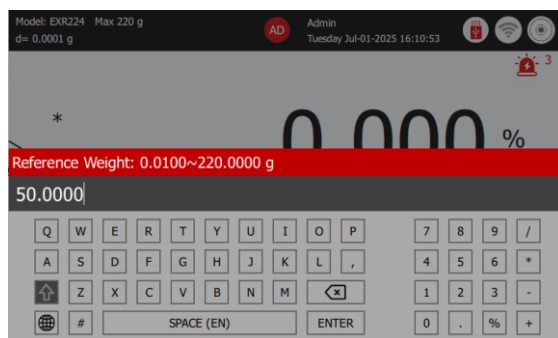

#### Set a new Reference Weight – Derived

- Place reference weight on the pan, and press Accept to establish a new Reference Weight
- The home screen displays 50.0022 g at the new Reference Weight

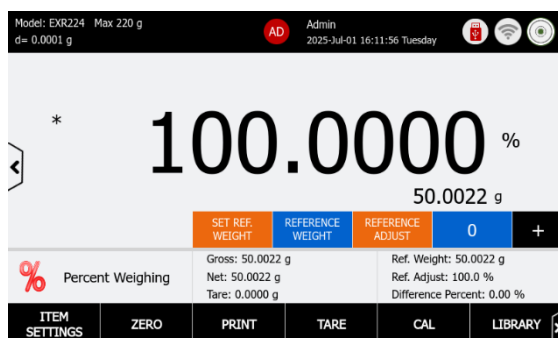

#### Step 2: Establish a Reference Adjust

Adjust the reference in a desired adjust.

- Press the REFERENCE adjust button and set the adjust percentage.
- Tap ENTER to save the value
- If a library is activated, the new Reference Weight will overwrite the existing value in the library.

- Example: The home screen displays an 80% Ref. Factor for adjusting the Reference Weight.

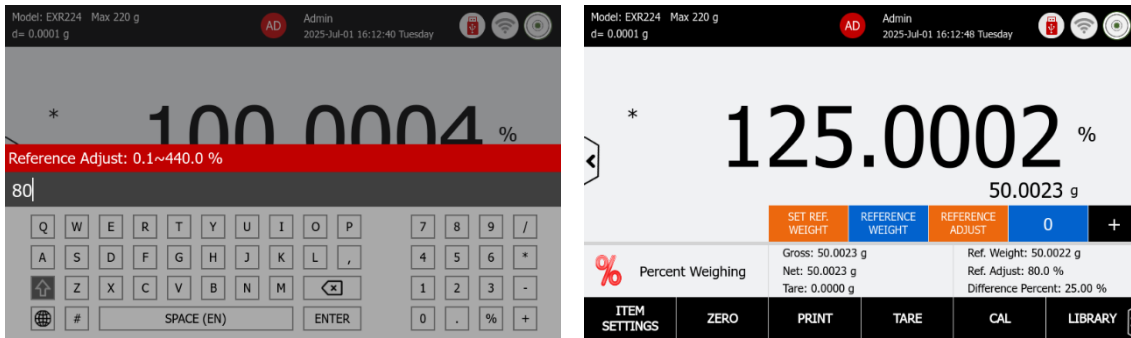

### Step 3: Weighing the Samples

Place an object on the pan. The difference between the sample and the Reference Weight is displayed as both a weight and a percentage.

Place samples on the pan, the balance will display the percentage of reference weight. The reference weight value, the set of ref factor and difference factor will display in the reference field.

## 4.5.3 Accumulate the data for Percent Weighing

Utilize the Statistics "+" function to aggregate samples based on the numbers of samples and generate statistical reports. The balance can store up to 99 accumulation records.

### Step 1: Set the Statistic Mode in Percent Weighing Mode

- Statistics can be determined Manual mode or automatically
- Automatic Mode: Weights are automatically recorded when stable

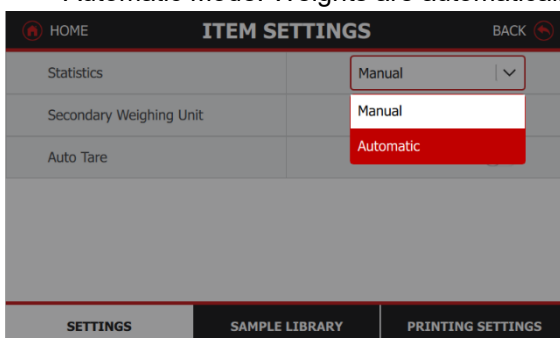

### Step 2: Statistics Report View

- To use the statistics function, enable it first in the Item Settings.
- Add items and press the "+ Statistic button to accumulate the statistical data
- Tap the statistics number to view the statistical results.
- Statistics Report View
  - The report content includes Start Time, Number of Samples, Total, Average, Maximum, Minimum, Range, Standard Deviation, Relative Deviation % and individual item percent weighing values.

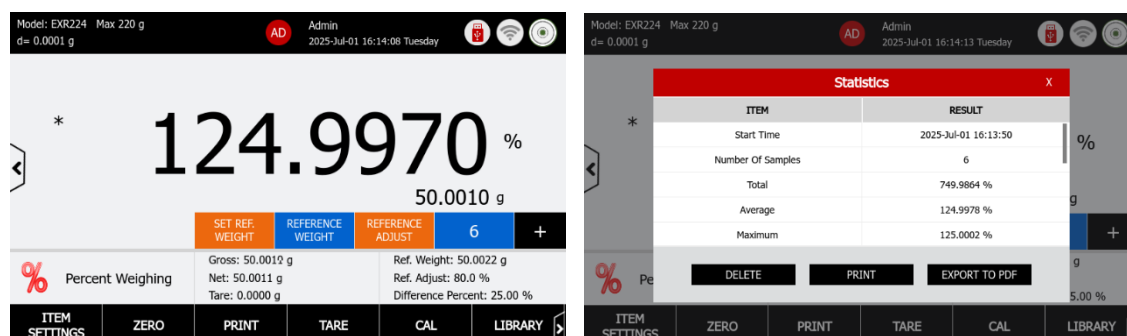

**Step 3: Print Report**

After reviewing the report, users can choose from several actions:

- Delete the statistics and restart the percent weighing process
- Print the report to a printer or PC based on the Print Settings
- Export the report as a PDF file to a USB flash drive

**4.5.4 Sample Library – Check Counting**

The Explorer EXR balance features a built-in library for managing multiple sample profiles. Up to 1,000 library records can be saved and recalled for use. The total library capacity and records are accessible across various application modes and through the library menu. When the library usage exceeds 80%, a pop-up message will alert the user to export the library or delete all items. The entire library menu, please refer to section 7.0.

**Create a Library Record**

- Press “+New Library” button to create a new Library.
- When a new library is created, it remains inactive. The operator has to activate the library after ticking the box.
- Press on the RUBISH BIN button to delete a library.
- After the library item is activated, the main screen will show the activated library number.

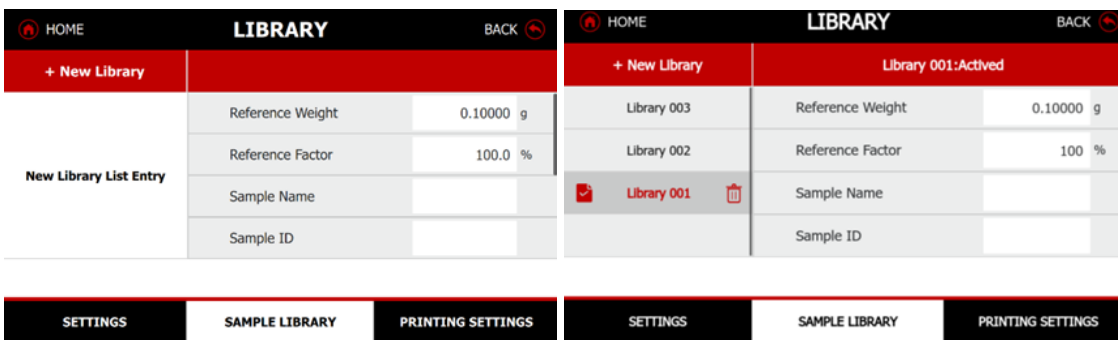

- Other sample information can be configured in the library, including sample name, sample ID, batch ID, lot ID, project ID, and the creation of 10 more customized IDs.

**4.5.5 Print Settings**

The Explorer EXR balance offers advanced print settings. Users can customize the output format and content and direct it to Excel or save it in a USB-compatible format. Additionally, users can review the print content to ensure all items are correctly selected before printing on paper or PC.

For details of Print Settings, please refer to section 6.0.





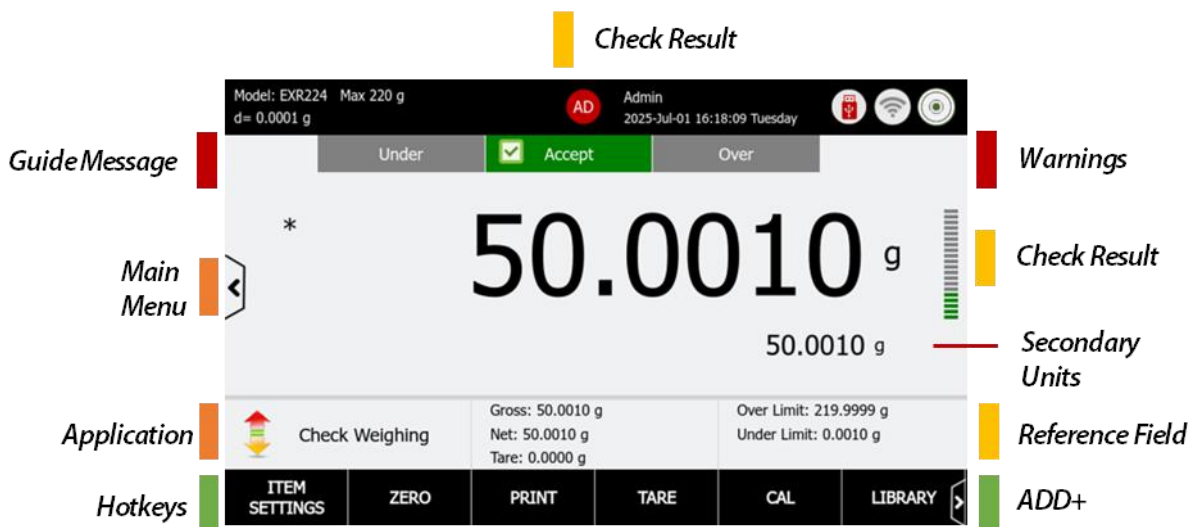

## 4.6 Check Weighing

- Use this application to check if the current sample pieces are within tolerances (e.g. an over and under limit, nominal weight vs.  $\pm$ tolerance).
  - This function serves to alert the operator of the check status and overload lights rather than requiring them to read the weighing value from the working distance
- In the lower portion of the home screen, select Check Weighing.
- Press **Tare** or **Zero** to start weighing.
- Place objects on the pan to check if the number of pieces is within the tolerances. The default over and under limit pieces is displayed.
- Setup the Over and Under Limits, and or Nominal weight & Tolerance before starting Check Weighing application.



### 4.6.1 Reference Field

Reference Field	Description
Over Limit	The piece value exceeds the maximum allowed threshold.
Under Limit	The piece value exceeds the maximum allowed threshold.
Item Settings	<ul style="list-style-type: none"> <li>Limits Setting Mode: check result with different limits setting.                             <ul style="list-style-type: none"> <li>Under and Over</li> <li>Nominal weight and Tolerance</li> <li>Nominal Weight and Percent Tolerance</li> </ul> </li> <li>Display: Weight or Check Status</li> <li>Audible Signal: The balance beeper will sound to alert the user of the check status.                             <ul style="list-style-type: none"> <li>Available Setting: Off, Under, Accept, Over, Under and Over</li> </ul> </li> <li>Primary Weighing Unit: The default unit is grams. The operator can switch to alternative weighing units and two custom units.</li> <li>Secondary Weighing Units: able to use 15 weighing units and 2 custom units</li> </ul>

	<ul style="list-style-type: none"> <li>The check status are divided into 20 segments to display the proportion of the current load relative to the total capacity. Each segment corresponds to 5% of the total capacity.</li> <li><b>Under-Orange</b> indicator</li> <li><b>Accept-Green</b> Indicator</li> <li><b>Over-Red</b> Indicator</li> </ul>
<p><b>Check Indicator</b></p>	<ul style="list-style-type: none"> <li>Color-coded status indicators (green / orange / red) correspond to sample weight, visually signaling:</li> <li> Acceptable (green)</li> <li> Underweight (orange)</li> <li> Overload (red)</li> </ul>

### 4.6.2 Begin Check Weighing

#### Step 1: Establish an Over Limits and Under Limits

- The Over Limit and Under Limit are set in Library.
- The main screen will display the check status of the current sample in the library.
- If the check status is either Under or Over, the status lights will turn red to indicate this.
- When the piece value exceeds the over limit, the screen will display Over.
  - When the piece value below the under limit, the screen will display Under.
  - When the piece value is above the under limit and below the over limit, the screen will display Accept.

In ITEM SETTINGS, select the Mode as Over and Under, Nominal Weight Tolerance, or Nominal Percent Tolerance.

Example: The home screen displays 60.0000 grams as Over Limited Value, and 50.0010 g is in the range of Accept.

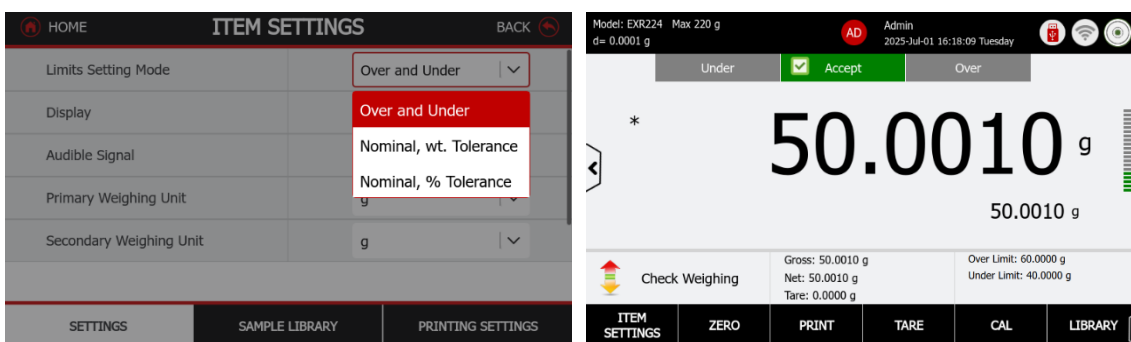

**Step 2: Set the check result display as Under, Accept and Over**

This function serves to alert the operator of the check status and overload lights rather than requiring them to read the weighing value from the working distance

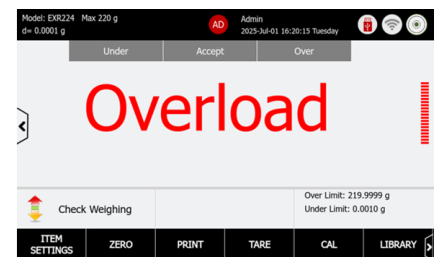
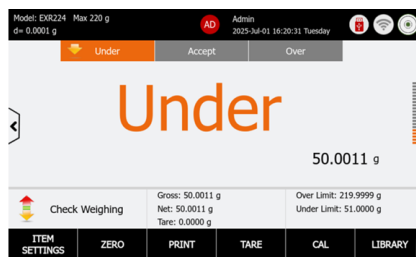
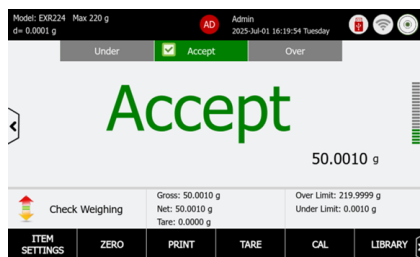
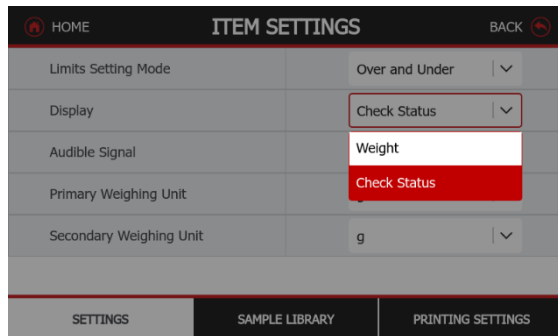

**Step 3: Set up the Audible Signal**

The operator can configure check sounds for Under, Accept, and Over in the Item Settings menu. Available Setting: Off, Under, Accept, Over, Under and Over

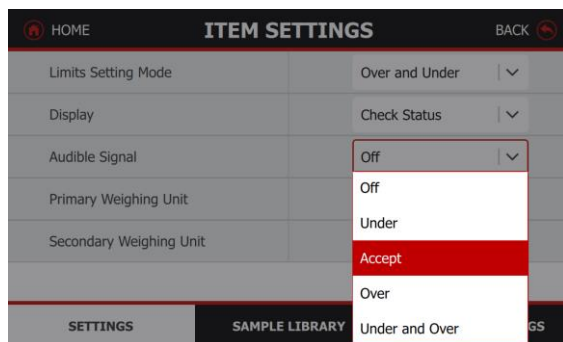

**4.6.3 Sample Library – Check Weighing**

The Explorer EXR balance features a built-in library for managing multiple sample profiles. Up to 1,000 library records can be saved and recalled for use. The total library capacity and records are accessible across various application modes and through the library menu. When the library usage exceeds 80%, a pop-up message will alert the user to export the library or delete all items. The entire library menu, please refer to section 7.0.

**Create, Activate and Delete a Library**

- Press “+New Library” button to create a new Library.
- When a new library is created, it remains inactive. The operator has to activate the library after ticking the box.
- Press on the RUBISH BIN button to delete a library.
- After the library item is activated, the main screen will show the activated library number.
- Example: Limits setting mode is Under and Over

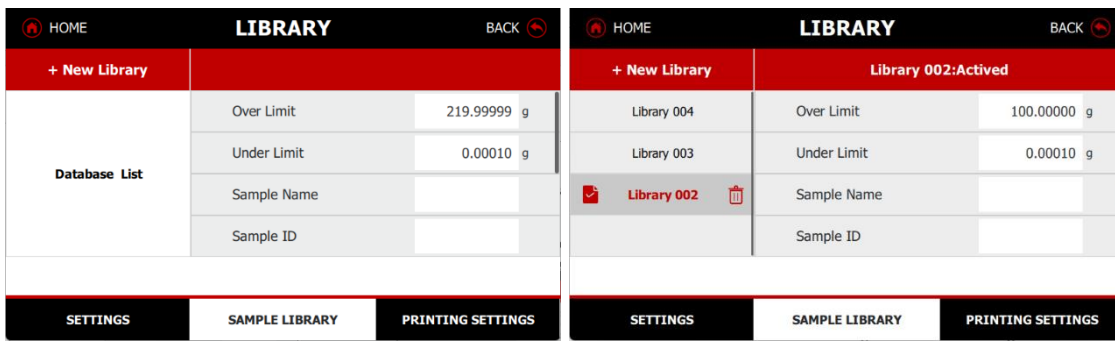

Example: Nominal weight and Tolerance

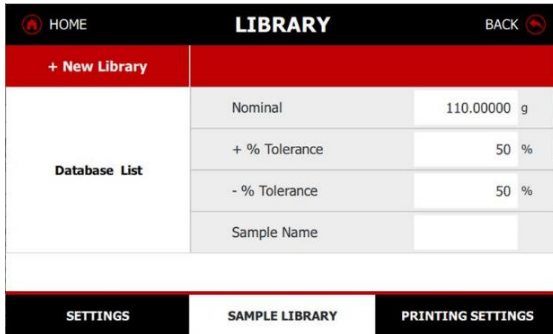

Example: Nominal Weight and Percent Tolerance

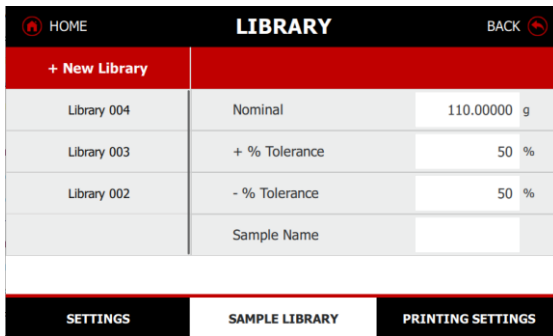

Other sample information can be configured in the library, including sample name, sample ID, batch ID, lot ID, project ID, and the creation of 10 more customized ID.

### 4.6.4 Print Settings

The Explorer balance offers advanced print settings. Users can customize the output format and content and direct it to Excel or save it in a USB-compatible format. Additionally, users can review the print content to ensure all items are correctly selected before printing on paper or PC.

For details of Print Settings, please refer to section 6.0.

## 4.7 Dynamic Weighing

This function serves to is set to weigh objects that are not stable, such as animals.

- In the lower portion of the home screen, select Dynamic Weighing.
- Press **Tare** or **Zero** to start weighing.
- Place the moving sample on the pan to achieve an average weight reading within seconds. The default weighing average time is displayed.
- Setup the Start Mode, Weighing Average Time, Auto Print Result before starting Check Weighing application.

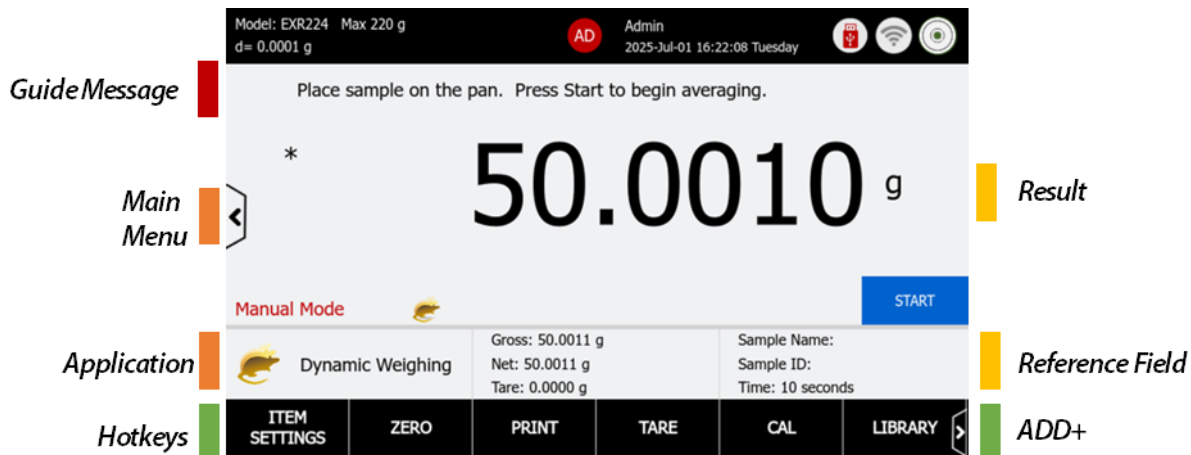

### 4.7.1 Application buttons

Application Button/ Reference Field	Description
<b>Start</b>	Press “Start” button to begin averaging.
<b>Time</b>	It displays the averaging time.
<b>Item Settings</b>	<ul style="list-style-type: none"> <li>• Start Mode: Automatic and Manual Automatic start without press Start button after second dynamic weighing</li> <li>• Auto Print Result: The averaged result will be printed immediately, without press “Print” button in the main screen.</li> <li>• Main Unit: The default setting is gram. It is able to change to other weighing units</li> <li>• Auto Tare: Automatic tare the container value</li> </ul>

### 4.7.2 Begin Check Weighing

#### Step 1: Setup the weighing averaging time in the Sample Library

- The weighing averaging time are set in Library.
- The main screen will display the averaging weight of the current sample.

Example: The screen displays 10 seconds as the averaging time.

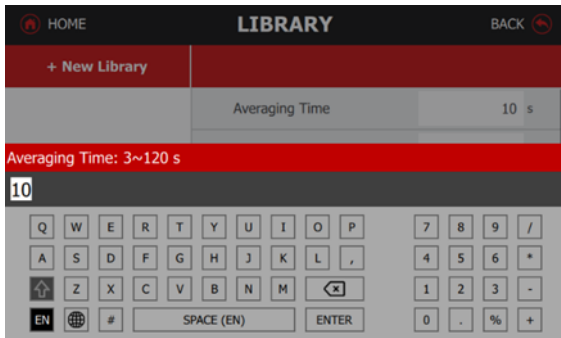

#### Step 2: Weigh movement sample on the weighing pan

- Place a sample on the weighing pan, and the balance will immediately calculate the average weight.
- The process will then commence a countdown based on the pre-set time configuration.
- The moving mouse icon will be stop at the end of the process, the result will be highlighted.

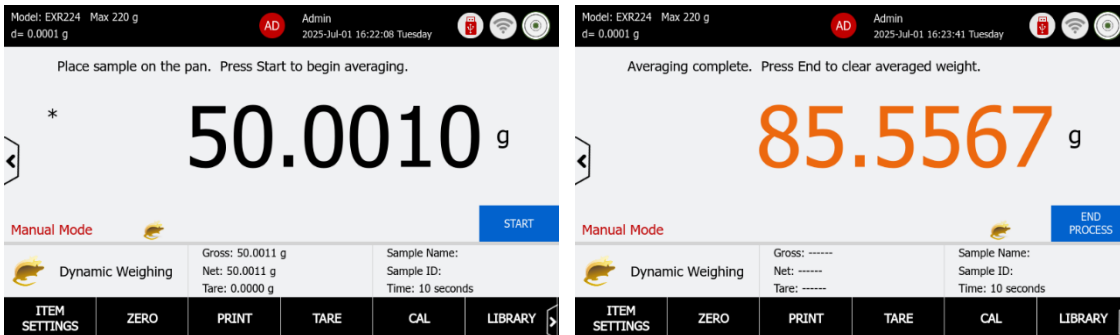

### 4.7.3 Sample Library – Dynamic Weighing

The Explorer EXR balance features a built-in library for managing multiple sample profiles. Up to 1,000 library records can be saved and recalled for use. The total library capacity and records are accessible across various application modes and through the library menu. When the library usage exceeds 80%, a pop-up message will alert the user to export the library or delete all items. The entire library menu, please refer to section 7.0.

#### Create, Activate and Delete a Library

- Press “+New Library” button to create a new Library.
- When a new library is created, it remains inactive. The operator has to activate the library after ticking the box.
- Press on the RUBISH BIN button to delete a library.
- After the library item is activated, the main screen will show the activated library number.
- Example: Limits setting mode is Under and Over

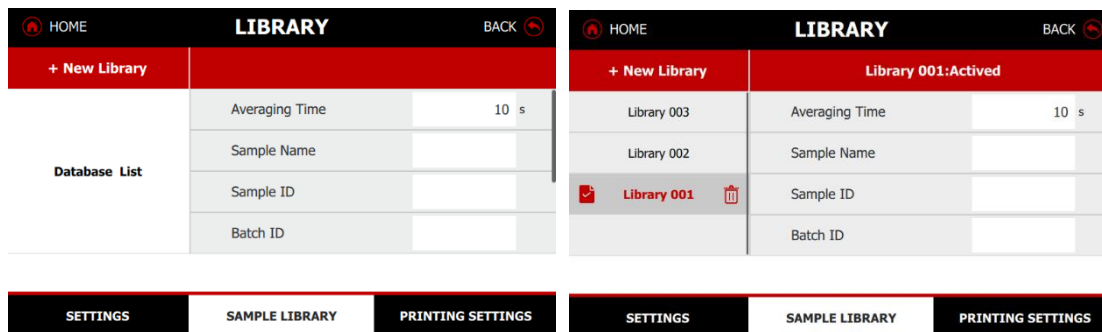

### 4.7.4 Print Settings

The Explorer EXR balance offers advanced print settings. Users can customize the output format and content and direct it to Excel or save it in a USB-compatible format. Additionally, users can review the print content to ensure all items are correctly selected before printing on paper or PC.

For details of Print Settings, please refer to section 6.0.

## 4.8 Totalization

This function serves to is used to sum the weights of multiple samples and report the statistical data for the series of samples.

- In the lower portion of the home screen, select Totalization.
- Press **Tare** or **Zero** to start weighing.
- Place the series sample on the pan. Press the Accumulate button to add up the weights. The total weight of the samples will be displayed in the reference field.
- Setup the Start Mode before starting Totalization application.

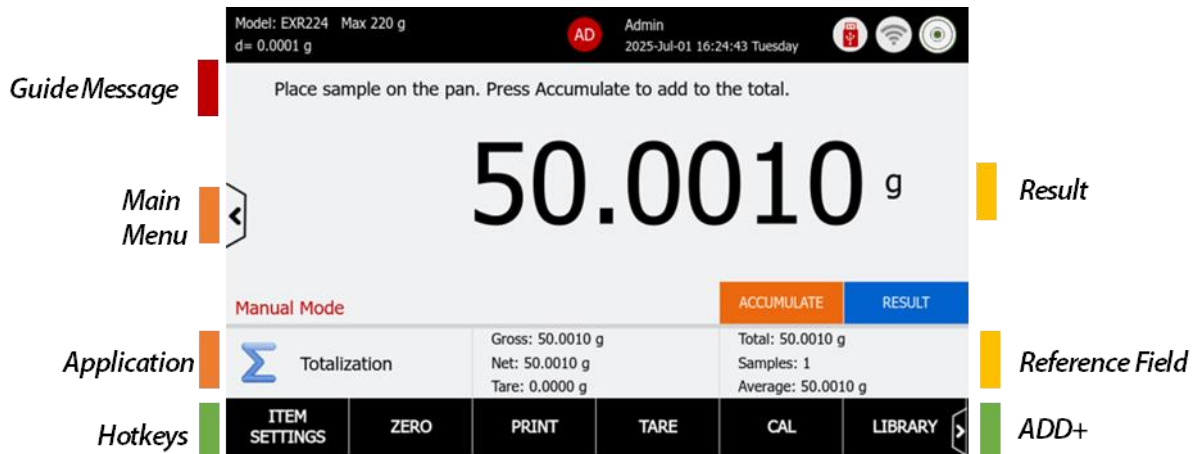

### 4.8.1 Application buttons

Application Button/ Reference Field	Description
<b>Accumulate</b>	Press the “Accumulate” button to add up the sample weight.
<b>Result</b>	After the weight series samples, press “Result“ button to review the total and other statistic data
<b>Item Settings</b>	<ul style="list-style-type: none"> <li>• Start Mode: Automatic and Manual. Automatic start without press Accumulate button after second sample weighing</li> <li>• Primary Weighing Unit: The default unit is grams. The operator can switch to alternative weighing units and two custom units.</li> <li>• Auto Tare: Automatic tare the container value</li> </ul>



## 4.8.2 Begin Totalization

### Step 1: Setup the start mode in the Item Settings

- Start Mode: Automatic and Manual. Automatic start without pressing Accumulate button after second sample weighing e.

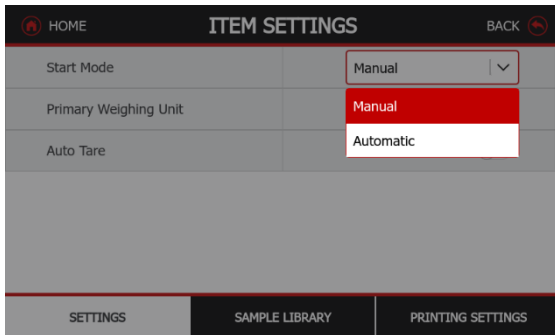

### Step 2: Weigh the samples on the weighing pan

- Place a sample on the weighing pan,
- Press the Accumulate button to add up the weights.

Example: The home screen displays 50.0010 gram as the fourth weight value and press Result button to review the data

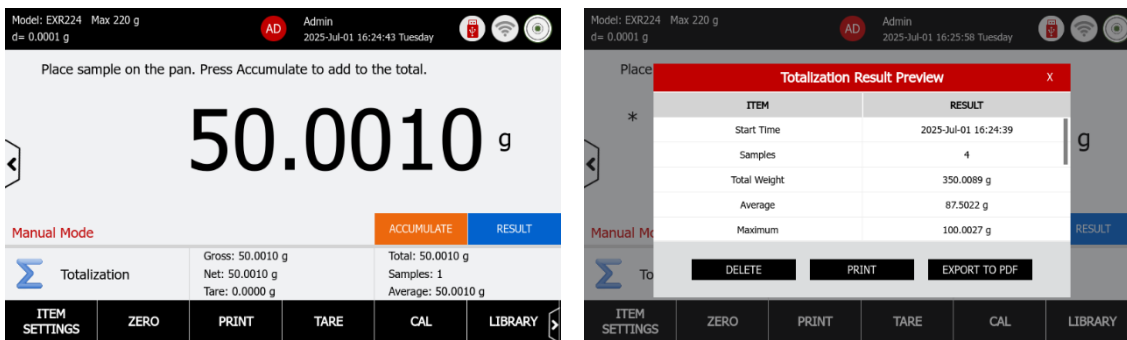

## 4.8.3 Accumulate the data for Totalization

Utilize the Accumulate function to aggregate samples and generate statistical reports.

The balance can store up to 99 accumulation records. Tap the Result to view the totalization and other statistical results.

The report content includes Start Time, Number of Samples, Total, Average, Maximum, Minimum, Range, Standard Deviation, Relative Deviation % and individual item weighing values.

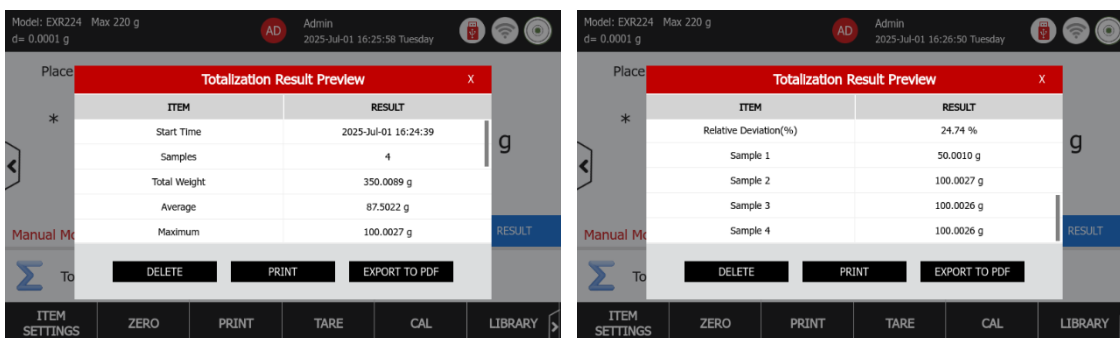

### 4.8.4 Sample Library – Totalization

The Explorer EXR balance features a built-in library for managing multiple sample profiles. Up to 1,000 library records can be saved and recalled for use. The total library capacity and records are accessible across various application modes and through the library menu. When the library usage exceeds 80%, a pop-up message will alert the user to export the library or delete all items. The entire library menu, please refer to section 7.0.

#### Create, Activate and Delete a Library

- Press “+New Library” button to create a new Library.
- When a new library is created, it remains inactive. The operator has to activate the library after ticking the box.
- Press on the RUBISH BIN button to delete a library.
- After the library item is activated, the main screen will show the activated library number.
- Example: Limits setting mode is Under and Over

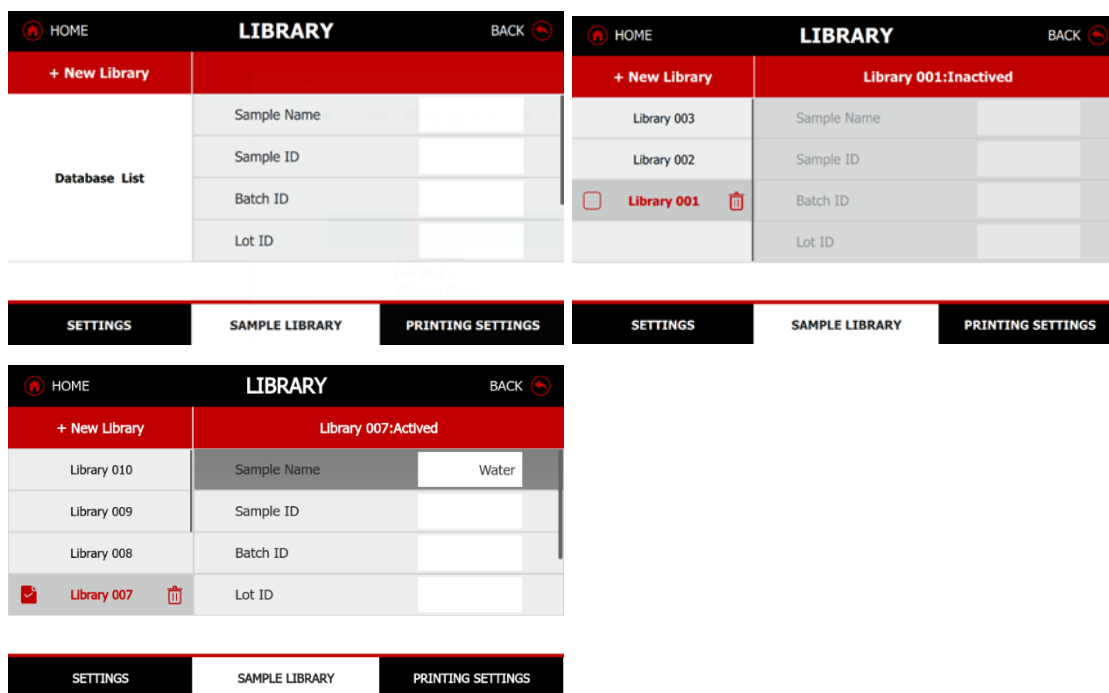

### 4.8.5 Print Settings

The Explorer EXR balance offers advanced print settings. Users can customize the output format and content and direct it to Excel or save it in a USB-compatible format. Additionally, users can review the print content to ensure all items are correctly selected before printing on paper or PC.

For details of Print Settings, please refer to section 6.0.

## 4.9 Formulation

This function serves to is used to combine various elements in proportionate amounts. It has two formulation modes, free recipe and recipe-based formulation. Both modes allow filer to increase the volume of the formulation, enabling the dosage form to achieve the desired size and weight. This is particularly important for formulations containing small amounts of active pharmaceutical ingredients (APIs).

- In the lower portion of the home screen, select Formulation.
- Press **Tare** or **Zero** to start weighing.
- Please the ingredients on the pan to start the process. The total weight of the samples will be displayed in the reference field.
- Setup the Filler weight before starting Formulation application.

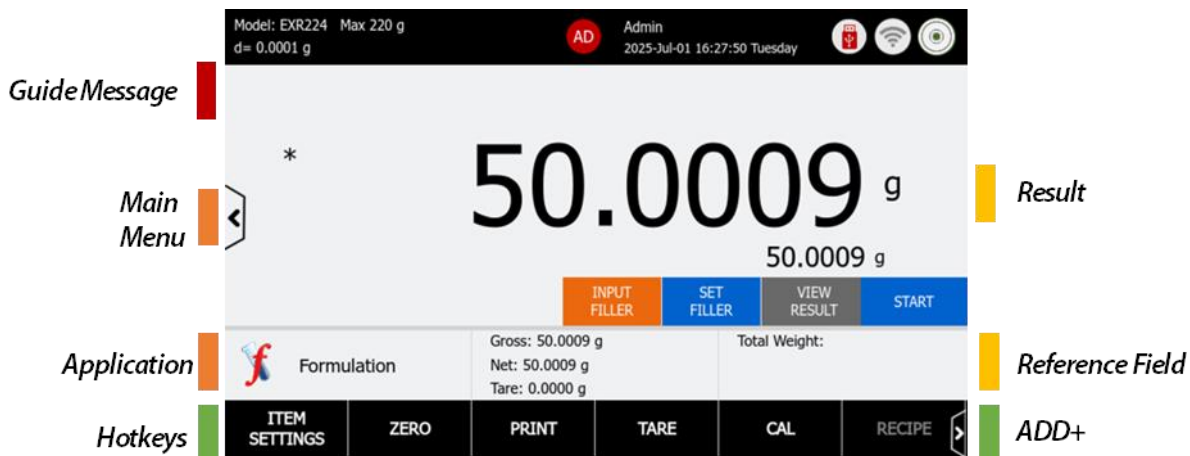

### 4.9.1 Application buttons

Application Button/ Reference Field	Description
Input Filler	Input Filler value
Set Filler	Place Filler on the pan and accept the value
View Result	Press this button to view the formulation results once the process has finished.
Start	Press the button to start formulation.
Diff. (wt.):	Display the weight difference.
Diff. (%)	Display the difference in percentage.
Target	Display the target weight based on the recipe library.
Item Settings	<ul style="list-style-type: none"> <li>• Formulation Mode: Recipe Based and Free Formulation</li> </ul>

	<p>The system can store up to 99 ingredients in a recipe, and there are 25 recipes available for setup.</p> <ul style="list-style-type: none"> <li>• Filler: Turn on and off</li> <li>• Primary Weighing Unit: The default unit is grams. The operator can switch to alternative weighing units and two custom units.</li> <li>• Secondary Weighing Unit: The operator can switch to alternative weighing units and two custom units.</li> <li>• Auto Tare: Automatic tare the container value</li> </ul>
--	---

### 4.9.2 Begin Free Formulation

#### Step 1: Setup the formulation mode in the Item Settings

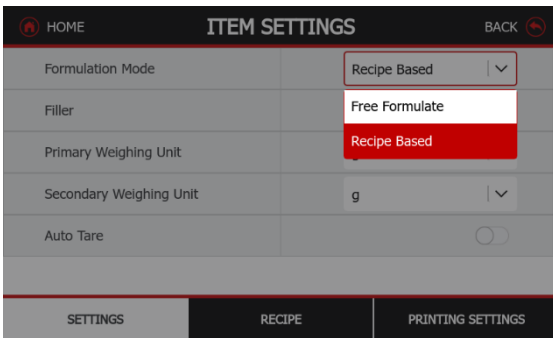

#### Step 2: Input Filler

- If the user has enabled the Filler option in the item settings, a filler value must be entered before creating a Free Recipe.
- The user can input the filler value by pressing the "Input Filler" button.
- Alternatively, the user can place the filler on the weighing pan and store the displayed value as the Filler weight.

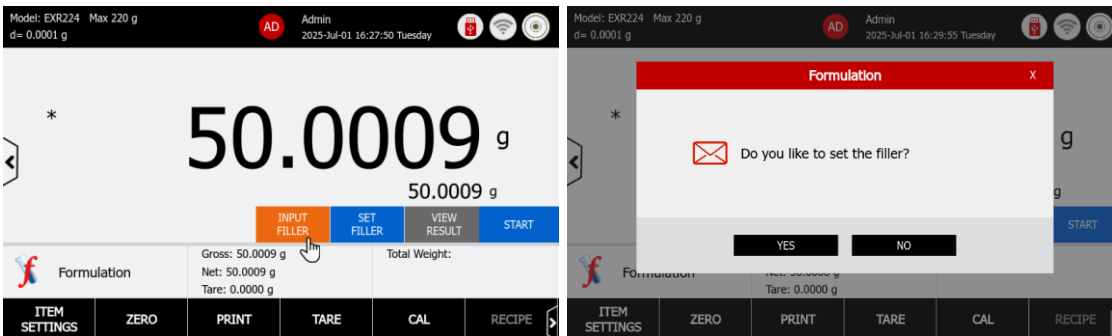

### Weigh the samples on the weighing pan

- Place a sample on the weighing pan,
- Press the Accumulate button to add up the weights.
- The user can choose to Add this free formulation to Recipe for future use in Recipe based formulation
- Print the Result or transfer the data to a PDF file using a USB flash drive.

Example: The home screen displays 67.7920 gram as the fourth weight value and press **View Result** button to review the data

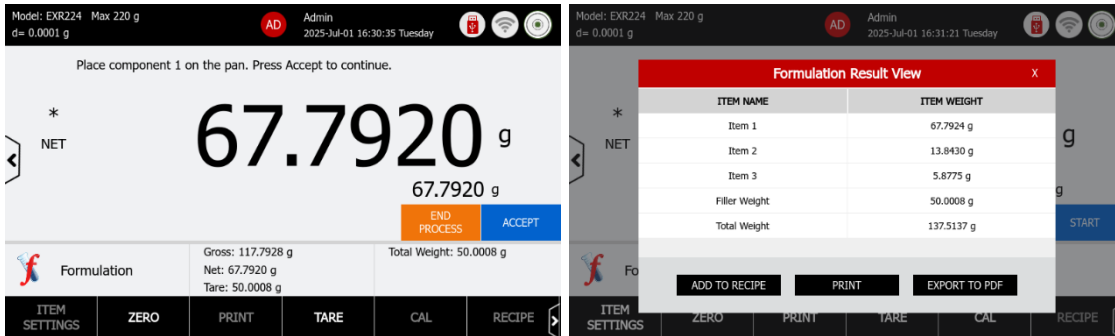

### 4.9.3 Begin Recipe Based Formulation

#### Step 1: Setup the formulation mode in the Item Settings

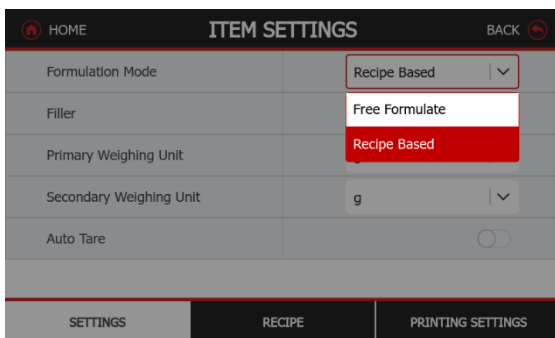

#### Step 2: Create Recipe ID and Name

- Press the **Create Recipe** button and create a New Recipe Name
- Click the tick box to activate Recipe 01
- Press the **Edit** button to go to next step

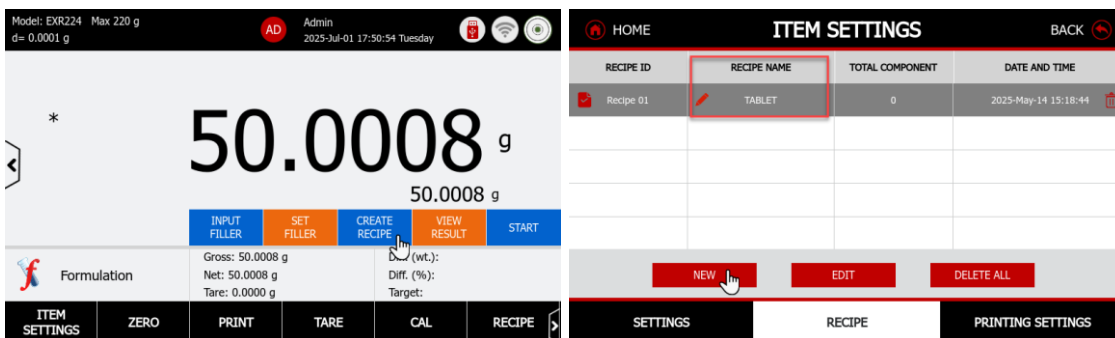

#### Step 2: Input Filler

- If the user has enabled the Filler option in the item settings, a filler value must be entered before creating a Free Recipe.
- The user can input the filler value by pressing the "Input Filler" button.

Alternatively, the user can place the filler on the weighing pan and store the displayed value as the Filler weight.

**Step 3: Create Recipe Items**

- Press **Add New** button to create ingredient names and their corresponding weight in grams.
- Use the **Up** and **Down** buttons to adjust the sequence order of the ingredients.
- Press the **Save** button before exiting the Recipe screen.
- Once the recipe has been saved, the user can press the **Start** button to begin the formulation process.

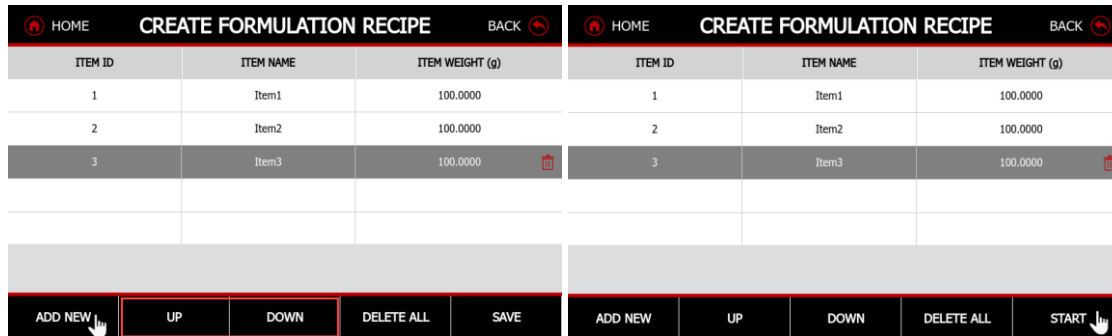

**Step 4: Weigh the ingredients in the order by activated Recipe.**

- Place the sample on the weighing pan and press the Accept button to confirm the weight.
- Follow the on-screen guide messages and repeat this process until all ingredients have been weighed.
- Once the process is completed, a result screen will appear with a button to review the data.
- The user can choose to Print the Result or transfer the data to a PDF file using a USB flash drive.

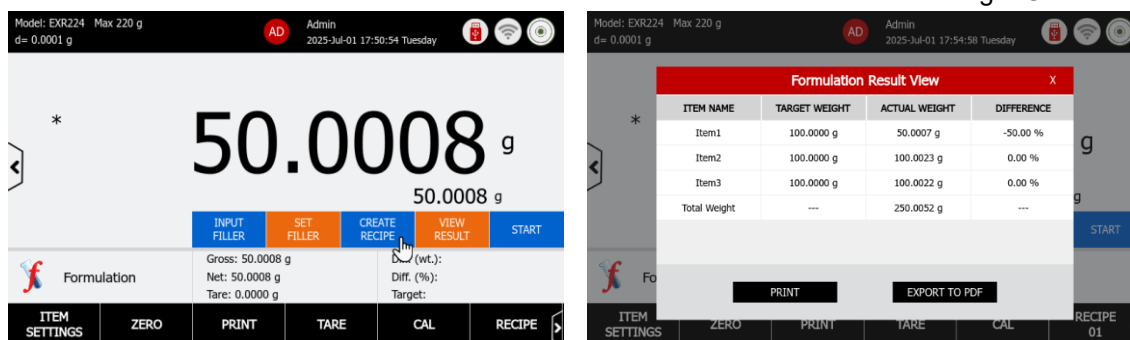

**4.9.4 Print Settings**

The Explorer EXR balance offers advanced print settings. Users can customize the output format and content and direct it to Excel or save it in a USB-compatible format. Additionally, users can review the print content to ensure all items are correctly selected before printing on paper or PC.

For details of Print Settings, please refer to section 6.0.

## 4.10 Differential

This function serves to is used to calculate the difference in weights of multiple samples taken at different times.

- In the lower portion of the home screen, select Differential.
- Press **Tare** or **Zero** to start weighing.
- Setup the Sample Groups number before starting Differential Weighing. The initial weight, final weight and difference weight will be displayed in the reference field.

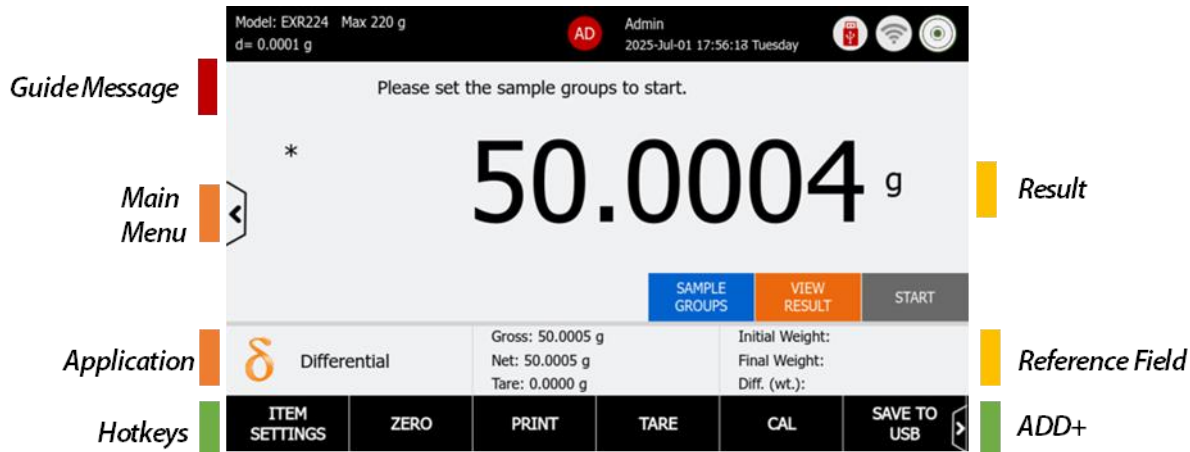

### 4.10.1 Application Buttons

Application Button	Description
<b>Sample Groups</b>	The number of sample groups requiring both initial and final weight measurements.
<b>View Result</b>	Press this button to view the Differential results once the process has finished.
<b>Start</b>	Press Start button to start the process
<b>Accept</b>	Accept the weight on the pan.
<b>End Process</b>	Press this button to complete the process
<b>Initial Weight</b>	Display the sample initial weight value.
<b>Final Weight</b>	Display the sample final weight value.
<b>Difference Weight</b>	Display the difference weight between initial and final measurement.
<b>Item Settings</b>	Sample Sequence: Off, A set of the initial and final weight

HOME ITEM SETTINGS BACK

Sample Sequence Off

Reciprocal Proportion Off

Absolute Value A set of the initial and final weight

Auto Tare

SETTINGS PRINTING SETTINGS

Reciprocal Proportion: ON/OFF

Absolute Value

Auto Tare: Automatic tare the container value

**Sample Sequence mode**

- Off: After weight the series samples initial weight, and then weight the final weight.
  - Weigh the initial weight of items 1, 2, 3, 4, 5, and then weigh the final weight of items 1, 2, 3, 4, 5.
- The set of sample measurement is design to place sample initial and final weight in a set
  - Weigh the initial weight of items 1 and then final weight,
  - After the first step, user weigh the initial weight of items 2 and then the final weight of items 2

**Reciprocal Mode**

- Set off:
  - $Difference\ Weight = Final\ Weight - Initial\ Weight$
- Set on:
  - $Difference\ Weight = Initial\ Weight - Final\ Weight$

**Absolute Value**

The difference result will be positive no matter initial weight is heavier than final weight

- Set on:
  - $Difference\ Weight = |Final\ Weight - Initial\ Weight|$

**4.10.2 Begin Differential Weighing**

**Step 1: Setup Group Sample: Multiple samples can be tested in the differential weighing application.**

- Input group sample number

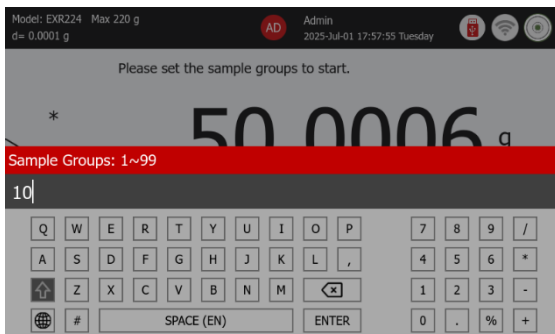



**Step 2: Establish the initial weight of each sample**

- Press START button and place the sample on the pan
- Press Accept to confirm the initial weight
- Follow the on-screen guide messages and repeat this process until all samples initial weight have been weighed.
- After that process, weigh the samples final weight in order, and the result screen will pop up at the end.

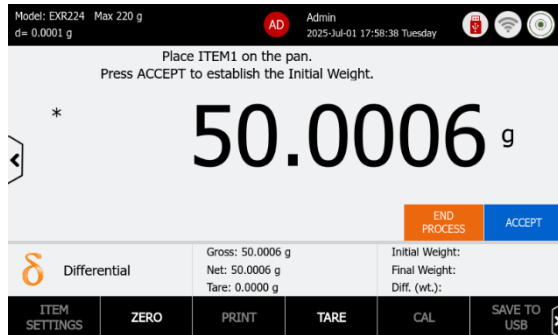

**Step 2: Result Review**

- The results include the initial weight, the final weight, the difference in weight, and the percentage difference.
- Users can clear the information, print the results to a PC or printer, and transfer the data to a PDF file via a USB flash drive.

#	INITIAL WEIGHT	FINAL WEIGHT	DIFFERENCE WEIGHT	DIFFERENCE %
ITEM1	9.4870 g	9.4870 g	0.0000 g	0.0 %
ITEM2	9.4870 g	9.4870 g	0.0000 g	0.0 %
ITEM3	9.4870 g	9.4870 g	0.0000 g	0.0 %
ITEM4	9.4870 g	9.4870 g	0.0000 g	0.0 %
ITEM5	9.4870 g	9.4870 g	0.0000 g	0.0 %

**4.10.3 Print Settings**

The Explorer EXR balance offers advanced print settings. Users can customize the output format and content and direct it to Excel or save it in a USB-compatible format. Additionally, users can review the print content to ensure all items are correctly selected before printing on paper or PC.

For details of Print Settings, please refer to section 6.0.

## 4.11 Peak Hold

This function serves to capture the maximum weight in a series of weighings.

- In the lower portion of the home screen, select Peak Hold.
- Press Tare or Zero to start weighing.
- Select the hold mode before you start the application mode

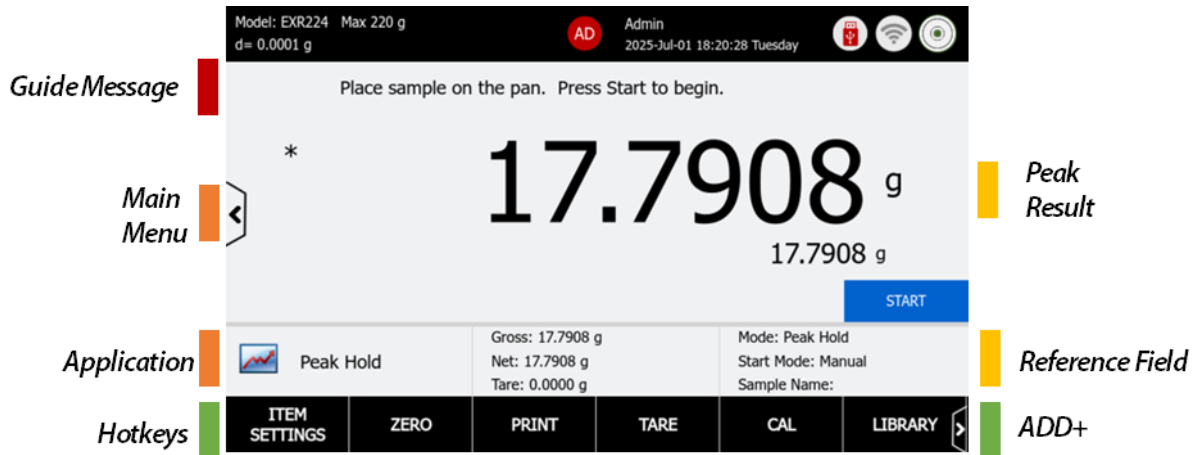

### 4.11.1 Application Buttons/ Reference Field

Application Button	Description
<b>Start</b>	Press Start button to begin the process
<b>Mode</b>	Peak Hold: Balance result screen will hold the highest weighing value. Display Hold: Balance result screen will hold the last weighing value.
<b>Start Mode</b>	Manual, Automatic
<b>Item Settings</b>	<ul style="list-style-type: none"> <li>• Mode: <b>Peak Hold</b>, Display Hold</li> <li>• Start Mode: <b>Manual</b>, Semi-Automatic, Automatic,</li> <li>• Stable Weight Only: <b>ON/OFF</b></li> <li>• Primary Weighing Unit: The default unit is grams. The operator can switch to alternative weighing units and two custom units.</li> <li>• Secondary Weighing Unit: able to alternative weighing units and 2 custom units</li> <li>• Auto Tare: Automatic tare the container value</li> </ul>
<ul style="list-style-type: none"> <li>• * Default settings are in bolds</li> </ul>	

### 4.11.2 Begin with Peak Hold

#### Step 1: Setup the Peak mode and Start Mode in the Item Settings

- Peak Mode: Select mode to Peak Hold. Peak Hold means balance will captures the maximum weight in a series of weighing.
- The user can choose the Start Mode: Manual, Semi-Automatic, and Automatic

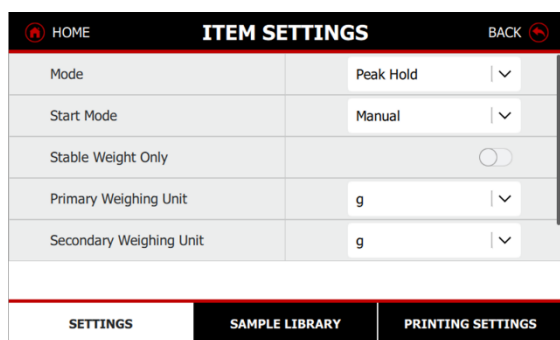

**Step 2: Weigh the samples on the weighing pan**

- Place a sample on the weighing pan
- Press the Start button to check the weight
- Press Stop button to restart the peak hold mode

Example: The home screen displays 67.7924 grams as the highest weight value.

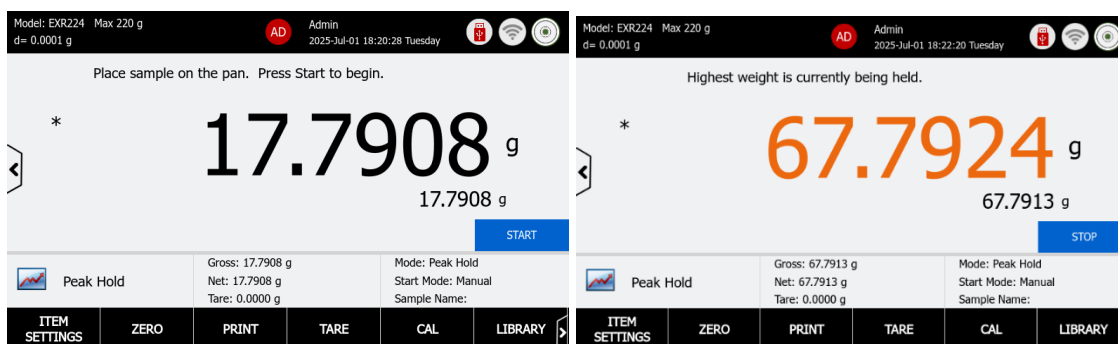

**4.11.3 Begin with Display Hold**

**Step 1: Setup the Peak mode and Start Mode in the Item Settings**

- Peak Mode: Select mode to Display Hold. Display Hold will hold the last weighing value.

**Step 2: Weigh the samples on the weighing pan**

- Place a sample on the weighing pan
- Press the Hold button to record the last weight.
- Press Cancel button to restart the display hold mode

Example: The home screen displays 17.7907 grams as the last weight value.

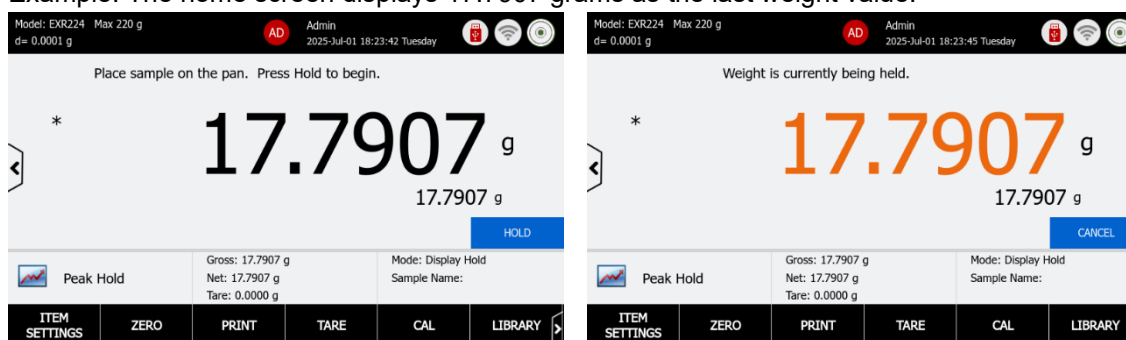

**4.11.4 Sample Library – Peak Hold**

The Explorer EXR balance features a built-in library for managing multiple sample profiles. Up to 1,000 library records can be saved and recalled for use. The total library capacity and records are accessible across various application modes and through the library menu. When the library usage exceeds 80%, a pop-up message will alert the user to export the library or delete all items. The entire library menu, please refer to section 7.0.

### Create, Activate and Delete a Library

- Press “+New Library” button to create a new Library.
- When a new library is created, it remains inactive. The operator has to activate the library after ticking the box.
- Press on the RUBISH BIN button to delete a library.
- After the library item is activated, the main screen will show the activated library number.
- Example: Sample Name is Parts.

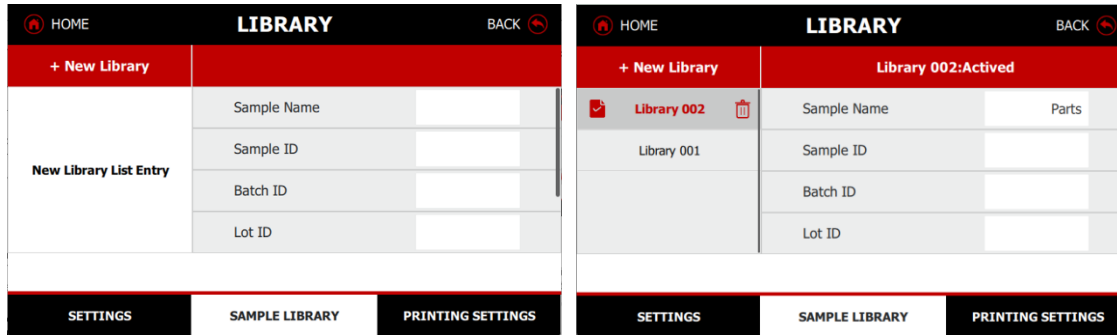

### 4.11.5 Print Settings

The Explorer EXR balance offers advanced print settings. Users can customize the output format and content and direct it to Excel or save it in a USB-compatible format. Additionally, users can review the print content to ensure all items are correctly selected before printing on paper or PC.

For details of Print Settings, please refer to section 6.0.

## 4.12 Density Determination

This function serves to is used to determines the density of a solid or a liquid.

A density determination kit must be installed on the balance. For installation instructions, please refer to the density kit manual. The balance software includes a built-in reference density table for water at temperatures ranging from 10°C to 30°C. Before attempting density measurements, please review this entire section thoroughly.

- In the lower portion of the home screen, select Density Determination.
- Press Tare or Zero to start weighing.
- User Help is available for review before setting up the process.

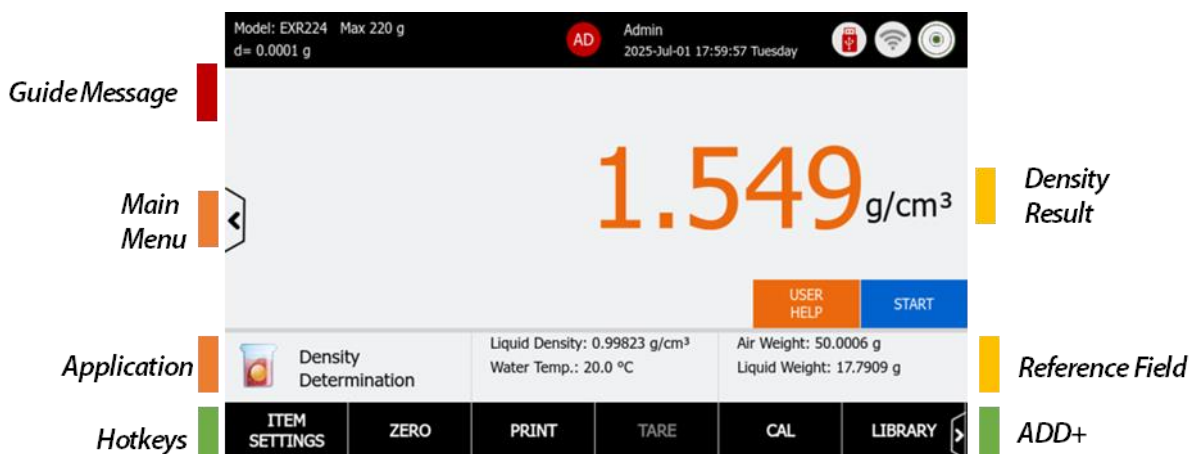

## 4.12.1 Application Buttons/ Reference Field

Application Button	Description
User Help	The user guide outlines the procedures for determining the density of solid materials.
Start	Press Start button to begin the process
Liquid Density	The current auxiliary liquid density value. Default setting is according to the Distilled water temperature
Water Temp.	Auxiliary liquid temperature. Default setting is according to the Distilled water temperature The water temperature range: 10-30 °C
Air Weight	The sample weight in the air
Liquid Weight	The sample weight in the auxiliary liquid
Sinker	Used for determining liquid density
Item Settings	g/cm <sup>3</sup> (the resolution of Density Value): <ul style="list-style-type: none"> <li>0.1 g/cm<sup>3</sup>, 0.01 g/cm<sup>3</sup>, <b>0.001 g/cm<sup>3</sup></b>, 0.0001 g/cm<sup>3</sup>, 0.00001 g/cm<sup>3</sup></li> </ul> Density Type: <b>Solid</b> , Liquid Liquid Type: <b>Water</b> , Other Liquid Porous Materials: <b>ON/OFF</b> Auto Print Result: Printout the density result without any button Auto Sample: Auto process the sample one after the other. Auto Tare: Auto Tare: Automatic tare the container value

Note: Bold text indicates default settings.

## 4.12.2 The Density Result Resolution

Item	Density Resolution
g/cm <sup>3</sup>	<ul style="list-style-type: none"> <li>0.01mg balance model: 0.1g/cm<sup>3</sup>, 0.01g/cm<sup>3</sup>, <b>0.001g/cm<sup>3</sup></b>, 0.0001g/cm<sup>3</sup>, 0.00001g/cm<sup>3</sup></li> <li>0.1mg balance model: 0.1g/cm<sup>3</sup>, 0.01g/cm<sup>3</sup>, <b>0.001g/cm<sup>3</sup></b>, 0.0001g/cm<sup>3</sup></li> <li>1mg balance model: 0.1g/cm<sup>3</sup>, 0.01g/cm<sup>3</sup>, <b>0.001g/cm<sup>3</sup></b></li> <li>0.01g balance model: 0.1g/cm<sup>3</sup>, <b>0.01g/cm<sup>3</sup></b></li> <li>0.1g balance model: <b>0.1g/cm<sup>3</sup></b></li> </ul>
* Default settings are in bolds	

### 4.12.3 Begin Density Determination for Solid Material

The principle of measuring the density of a solid using a balance is based on the definition of density and the measurement of mass and volume. Density is defined as the mass of an object divided by its volume.

When measuring the density of a solid, distilled water is generally used as the medium. This is because the density of distilled water is known (it reaches its maximum density of 1 g/cm<sup>3</sup> at 4 °C), and it does not chemically react with most solid materials, thus meeting the requirements of Archimedes' principle. Archimedes' principle states that when an object is fully or partially submerged in a fluid, it experiences an upward buoyant force. This buoyant force is equal to the weight of the fluid that the object displaces.

#### Preparation

- Set up the Density Kit on the balance, follow the instruction manual of Density Kit



- 
- When measuring the density of a solid, distilled water is generally used as the medium. This is because the density of distilled water is known (it reaches its maximum density of 1 g/cm<sup>3</sup> at 4 °C), and it does not chemically react with most solid materials, thus meeting the requirements of Archimedes' principle that the liquid should not react with the material of the sample and should be able to completely wet the sample material.
- Press the Item Setting button to setup the Density Settings
- Confirm the following Setups are selected:
  - Density Type: Solid
  - Liquid Type: Water
    - ◆ If user use other liquid, change the liquid density in Sample Library
  - Porous Material: Off
  - Water Temperature: Change the Water temperature in Sample Library (default is 20 °C )

LIBRARY	
+ New Library	
Database List	Water Temp. 20.0 °C
	Sample Name
	Sample ID
	Batch ID
<div style="display: flex; justify-content: space-between;"> <span>SETTINGS</span> <span>SAMPLE LIBRARY</span> <span>PRINTING SETTINGS</span> </div>	

- Press BACK to return to the Density Determination home screen.

- Prepare the Sample: Ensure the solid material sample is clean and dry.
- Push the sample down into the liquid until it is fully submerged

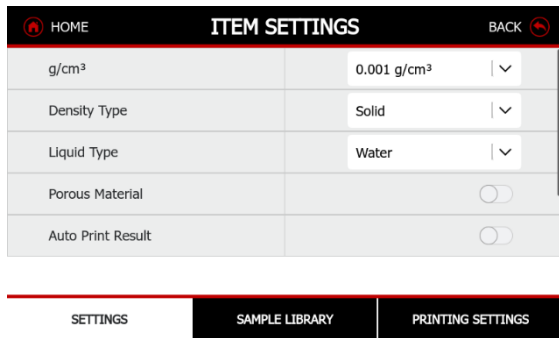

**Create, Active and Delete a library**

- Press “+New Library” button to create a new library
- When a new library is created, it remains inactive. The operator has to activate the library after ticking the box.
- Press on the RUBISH BIN button to delete a library.
- After the library item is activated, the main screen will show the activated library number.

For instance, the screen below displays Library 004 as the sample utilizing the active library settings.

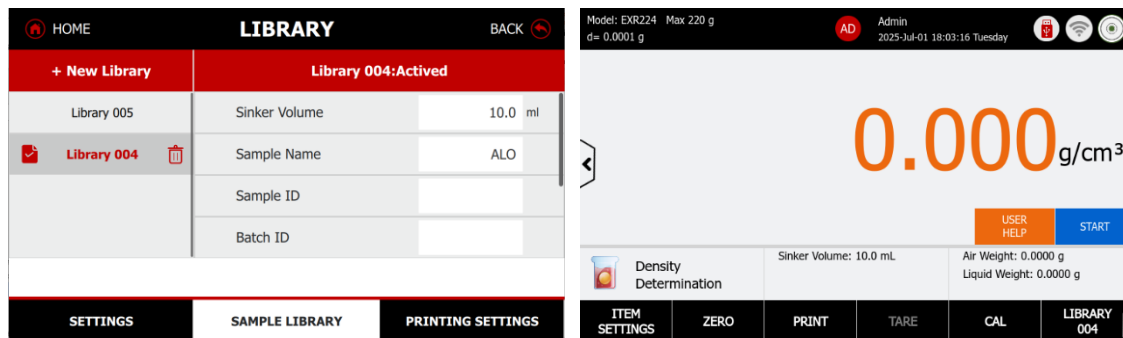

**Immersion Process**

- Initial Weighing: Press Start to weigh the dry material sample in air and the balance will record its mass

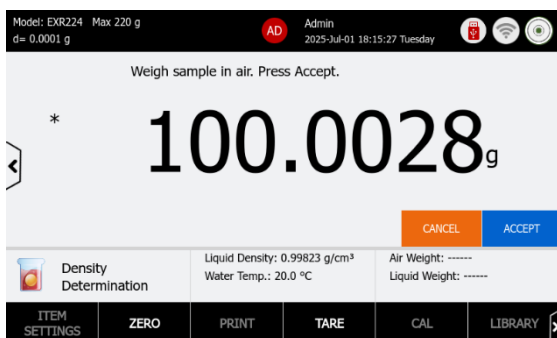

- Water Immersion: Fully submerge the sample in water, ensuring that the water fills all cavities, and no bubbles are trapped.
- Weighing in Water: Press Accept button after the sample is fully saturated with water, weigh the sample again

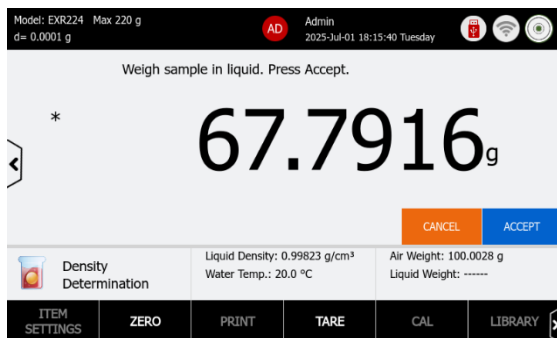

- Density Result is shown in the screen, user can print it or save it to the USB flash driver.

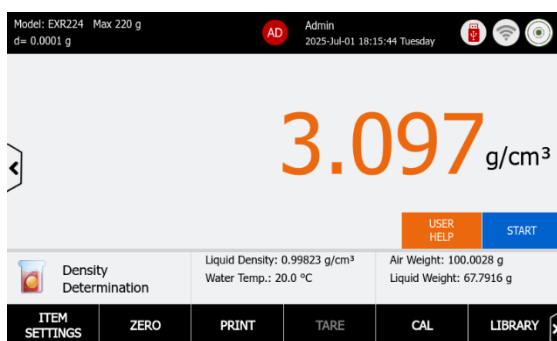

#### 4.12.4 Begin Density Determination for Porous Material

The method of testing the density of porous materials using the oil immersion method mainly involves the following steps:

##### Preparation

- Setup the Density Kit on the balance, follow the instruction manual of Density Kit



- Press the Item Setting button to setup the Density Settings



- Confirm the following Setups are selected:
  - Density Type: Solid
  - Liquid Type: Water
  - Porous Material: On
  - Sample Library: Change the Oil Density (default is 0.8000 g/cm<sup>3</sup>)
  - Press BACK to return to the Density Determination home screen.

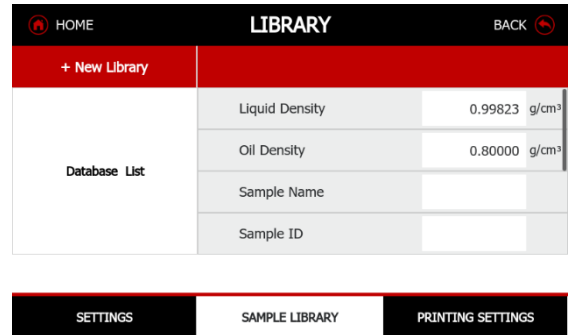

- Select Appropriate Oil: Choose an oil that has good wettability with the porous material. Commonly used oils include kerosene, light machine oil, etc.
- Prepare the Sample: Ensure the porous material sample is clean and dry.

**Immersion Process**

- Initial Weighing: Weigh the dry porous material sample in air and the balance will record its mass

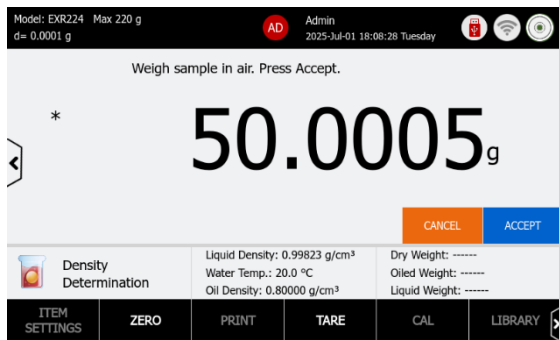

- Oil Immersion: Submerge the sample completely in the selected oil. Ensure that the oil fills all the open pores of the material. Weight oil sample in the air and press Accept button. The weight of the oiled porous sample must be less than the weight of the sample in air.

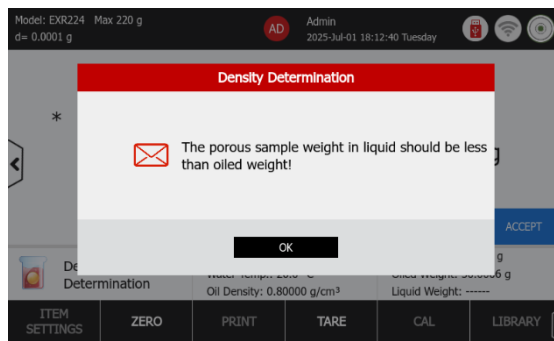
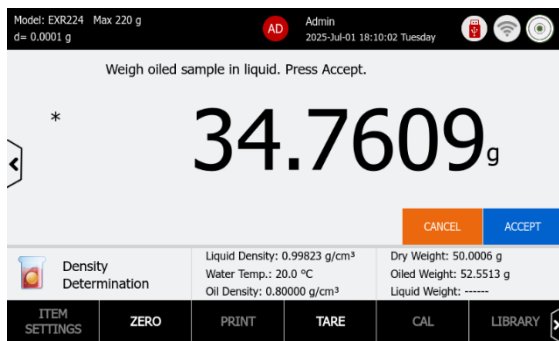

- Weighing in Oil: After the sample is fully saturated with oil, weigh the sample again while it is still submerged in the oil. Weight oil sample in the liquid and press Accept button.

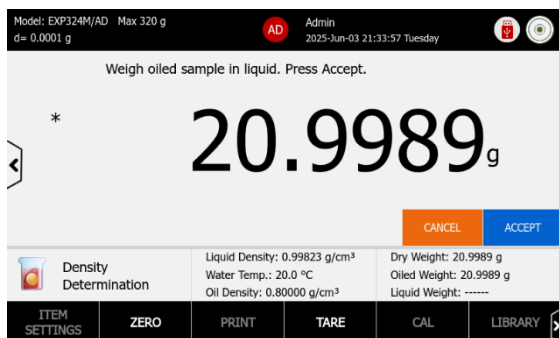

- Density Result is shown in the screen, user can print it or save it to the USB flash driver.

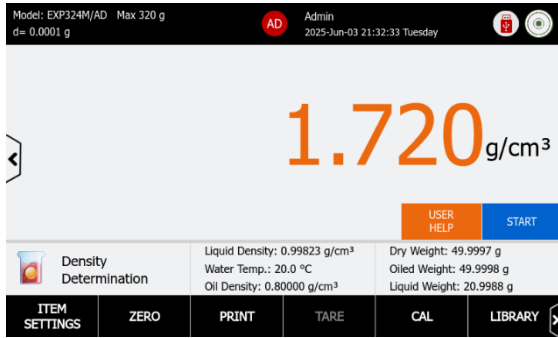

### 4.12.5 Begin Density Determination for Liquid Material

The principle of measuring the density of a liquid using a balance is based on Archimedes' principle and the definition of density.

#### Preparation

- Setup the Density Kit on the balance, follow the instruction manual of Density Kit.
- A sinker is required as it serves as a standard volume reference for determining liquid density.
- Prepare the Sample: Ensure the liquid is free of bubbles or gas.
- Setup the Sinker Volume in the Sample Library, the default setting is 10.0 ml

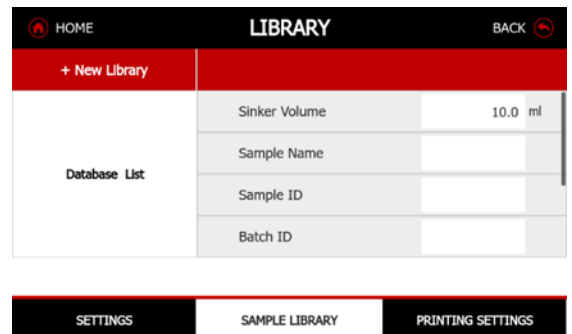

#### Immersion Process

- Initial Weighing: Weigh the sinker in air and the balance will record its mass. Press Accept to continue.

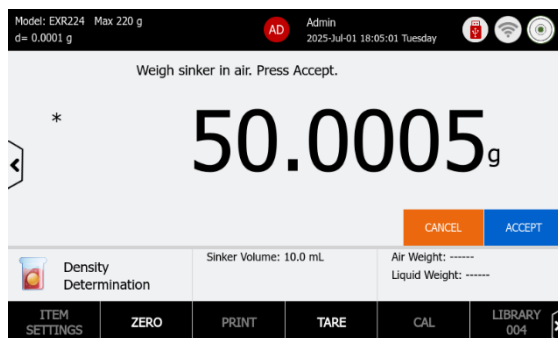

- Liquid Immersion: Submerge the sinker completely in the liquid. Press Accept to continue.

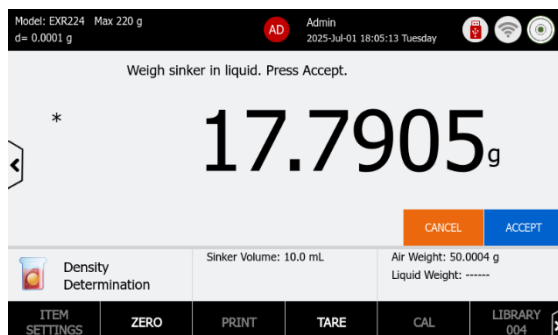

- Density Result is shown in the screen, user can print it or save it to the USB flash driver.

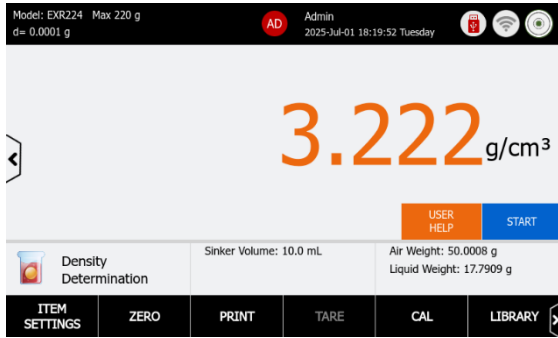

### 4.12.6 Sample Library – Density Determination

The Explorer EXR balance features a built-in library for managing multiple sample profiles. Up to 1,000 library records can be saved and recalled for use. The total library capacity and records are accessible across various application modes and through the library menu. When the library usage exceeds 80%, a pop-up message will alert the user to export the library or delete all items. The entire library menu, please refer to section 7.0.

#### Create, Activate and Delete a Library

- Press “+New Library” button to create a new Library.
- When a new library is created, it remains inactive. The operator has to activate the library after ticking the box.
- Press on the RUBISH BIN button to delete a library.
- After the library item is activated, the main screen will show the activated library number.
- Example: Water Temperature is 20 °C

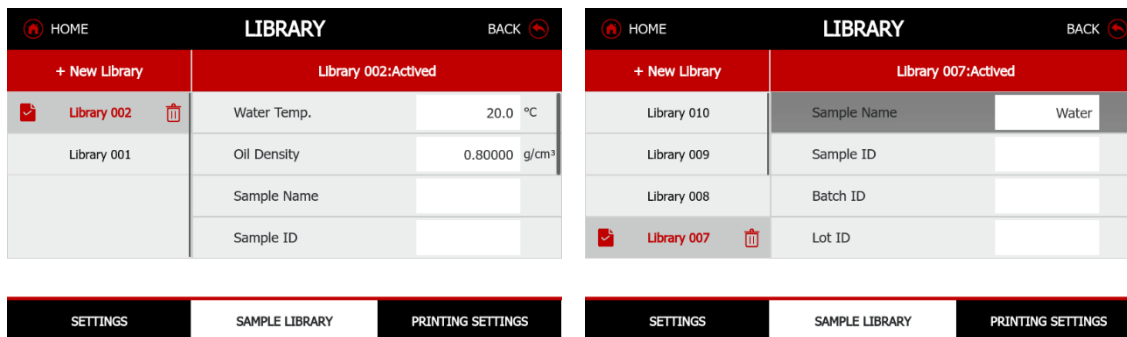

### 4.12.7 Print Settings

The Explorer EXR balance offers advanced print settings. Users can customize the output format and content and direct it to Excel or save it in a USB-compatible format. Additionally, users can review the print content to ensure all items are correctly selected before printing on paper or PC.

For details of Print Settings, please refer to section 6.0.

## 5 Menu Settings

### 5.1 Menu Navigation

To change a menu setting, navigate to that setting using the following steps:

#### Enter the Menu

The main menu button is hidden on the middle-left side. Press the button to reveal the menu.

#### Select the Sub-Menu

Locate the item on the Main Menu List and touch it. The display will highlight the item in red for about 1 second, after which the sub-menu will appear.

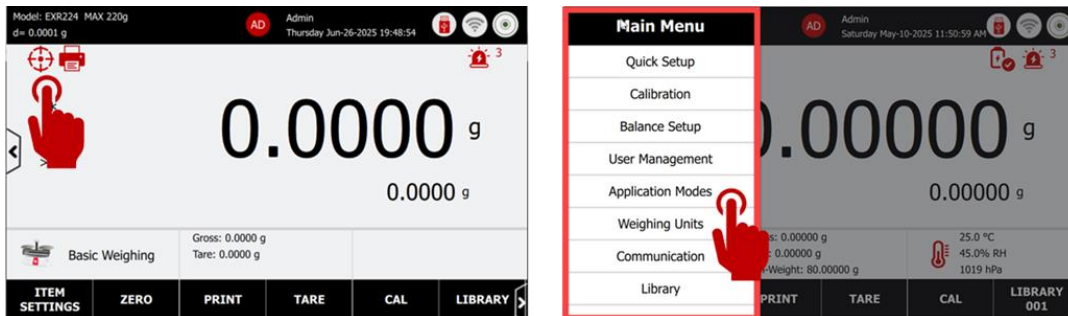

### 5.2 Menu Structure

Quick Setup	Calibration	Balance Setup	User Management	Application Modes	Weighing Units	Communication	Library	Maintenance	Factory Reset	Log Off	Power Off
Language	Internal Calibration	Language	User Management	Basic Weighing	Gram	RS232	Library List	Diagnostics Menu	Reset All		
Time Synchronization	Automatic Calibration	Time Synchronization	Group User Permissions	Parts Counting	Milligram	USB	Delete Library	Software Upgrade	Quick Setup		
Time Zone: (UTC)	Span Calibration	Time Zone: (UTC)	Password Policy	Check Counting	Carat	ETHERNET	Import Library	Service Log	Calibration		
Date and Time	Perform Internal Calibration	Date and Time		Percent Weighing	Grain	WIFI&BLUETOOTH	Export Library	Service Menu	Balance Setup		
Automatic Calibration	Perform Span External Calibration	Balance Name		Check Weighing	Pennyweight				Application Modes		
User Management	Calibration History	Change Password		Dynamic Weighing	Momme				Weighing Units		
System Log		Fingerprint		Totalization	Mesghal				Communication		
Balance Info		Fingerprint Setting		Formulation	Tical				Library		
Digital Leveling		Stability Indicator Range		Differential	Tola						
Repeatability Test		Filter Level		Density Determination	Baht						
		Auto Zero Tracking		Peak Hold							
		Gross Indicator									
		Graduation									
		Ionizer									
		Approved Mode									
		Auto Doors									
		Sensor									
		System Log									
		ECO									

### 5.3 Quick Setup

The Quick Setup menu is designed for first-time users. By quickly navigating through this menu, you can easily configure the most desired functions.

#### 5.3.1 Language

Set the language for menu display and pop-up messages. The default setting is configured based on the country of sale. The 13 available languages are English, German, French, Spanish, Italian, Polish, Czech, Hungarian, Portuguese, Chinese, Japanese, Korean, and Turkish.

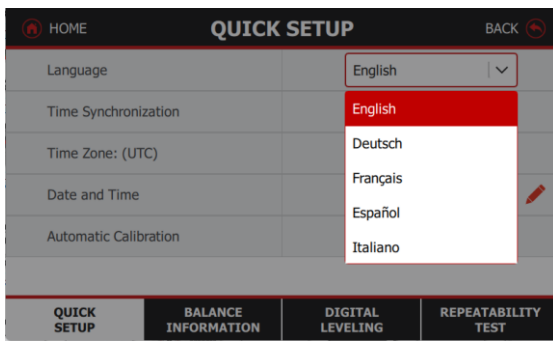

### 5.3.2 Time Synchronization/ Network Server

The new balance features Synchronization with Network (NTP function) which can use consistent time and data from the local network. The NTP system supports DNS domain name resolution.

- When you input the address of a public domain server, it will automatically convert it into an IP address. Here are some examples of NTP public time server address
  - “0.europe.pool.ntp.org” when the location is in Europe
  - “cn.ntp.org.cn” for China
  - “0.us.pool.ntp.org” for the US

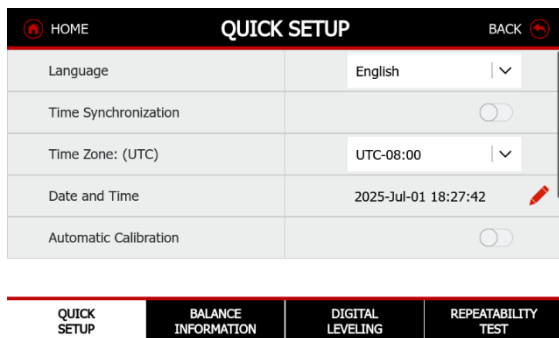

### 5.3.3 Date and Time

If you are offline use the balance, the new date/time setting fulfill your documentation needs with UTC time zone and customized the time format MMM-DD-YY HH-MM-SS and working weekdays setting.

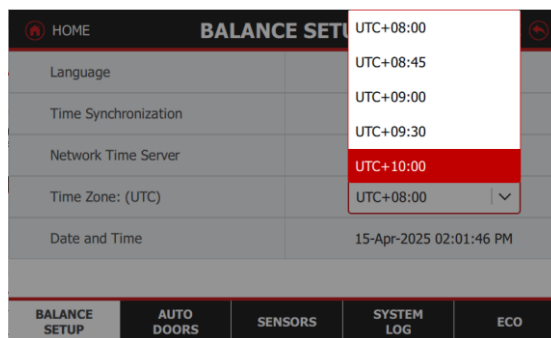
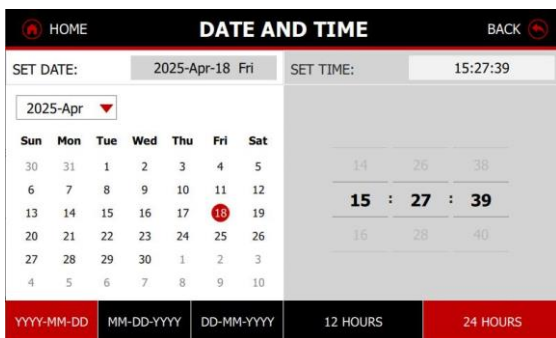

### 5.3.4 Automatic Calibration

When Automatic Calibration is set ON, the balance performs a self-calibration: AutoCal will automatically calibrate the Balance (using the internal mass) each time there is a change in temperature significant enough to affect accuracy or every 11 hours.

An information screen will appear when an Automatic Calibration is about to start. Three option buttons will be displayed:

- Now – Press to perform the calibration directly.

- After 5 min – Press to perform the calibration after 5 minutes.
- Deactivate – Press to deactivate the Automatic Calibration function

### 5.3.5 User Management

When **User Management** is set ON, the balance will be able to create up to 200 user accounts, featuring four predefined roles. 4-level user management with an underdefined user group with access rights to the balance.

- Administrator (1)
- Supervisor (maximum of 20)
- 179 allocated to other roles like operator, log viewer, and group users

See detail setting in User Management section 5.9.

### 5.3.6 System Log

When the **System Log** is enabled, the balance can store up to 100,000 log entries. It has consist with System Log, Calibration Log, Printed Data Log, and Failure log. These electronic records include changes made on balance setting will keep records in system log file. e.g. every printed data, date/time change, balance setting changes, perform calibration action, user log in/log out, user account create/edit/delete and etc.

See detail setting in Maintenance section 8.0.

### 5.3.7 Balance Information

The balance information will display the Information displayed includes:

- Balance Information: Balance ID, Balance Model, Balance Software Version, Digital Loadcell Type, and Digital Loadcell Software Version
  - The balance max capacity, readability, d and (e) value are displayed in the Upper left corner of the main screen.

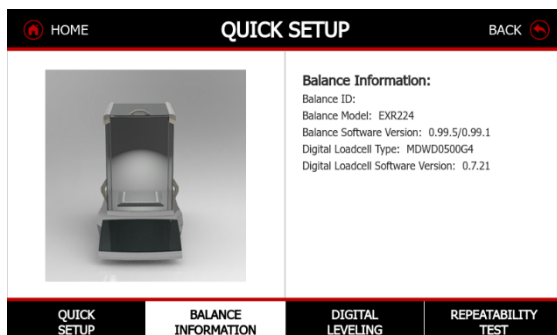

### 5.3.8 Digital Leveling

The Leveling System is a simple and effective balance feature for the first setup user and the technician dealers. The internal digital level bubble will indicate the bubble real time status.

- Press the leveling button and adjust the leveling feet according to the position of the digital bubble until the bubble is centered.
- Before starting the motorized leveling process, kindly remove the weight from the weighing pan.

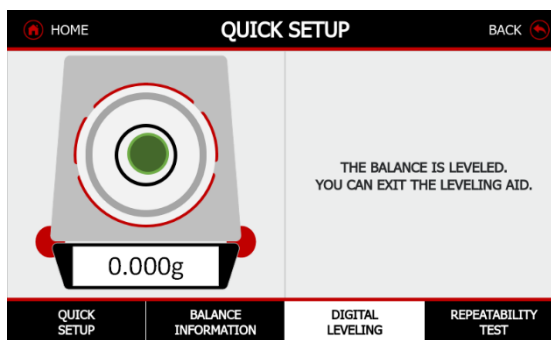
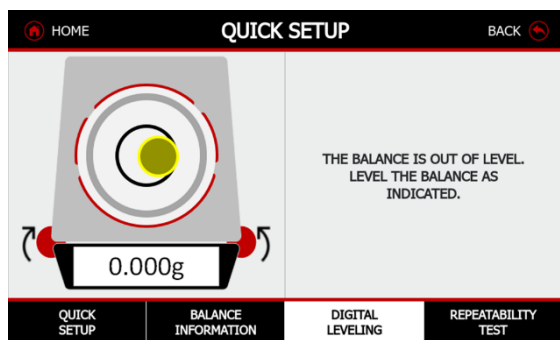

- After the level the balance, the digital bubble will display green at the upper right corner in the main screen
- If the leveling system fail to level the balance successfully, move the balance to a relatively flat surface. The warning notification will pop up.

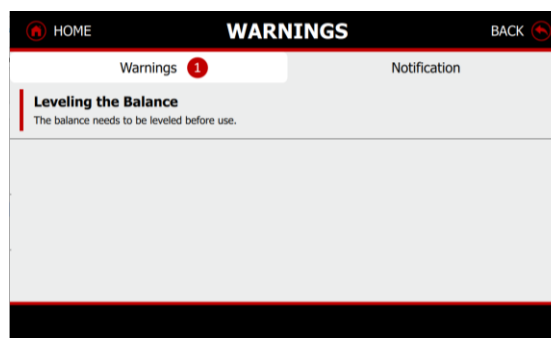
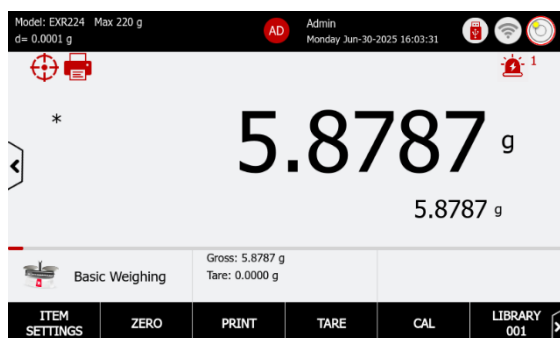

### 5.3.9 Repeatability Test

This function is designed to conduct the daily repeatability test of the balance. Users can perform a 10-time repeatability test using weights that are close to their daily working point.

**Note:** To determine the minimum weight in accordance with <USP41>, test environment must be equivalent to standard lab <USP1205> and the test weights must be certified and their values checked periodically.

- Press Repeatability Test tab and then follow the onscreen instruction.

**Step 1: Set Number of Repeatability Tests, Test Weight ID, Test Weight Value and Test Weight Class in this menu.**

The Number of Tests, Test Weight ID, Test Weight Value, and Test Weight Class can be set in accordance with the workshop's standard procedure.

- The default setting is 10 times in Number of Test

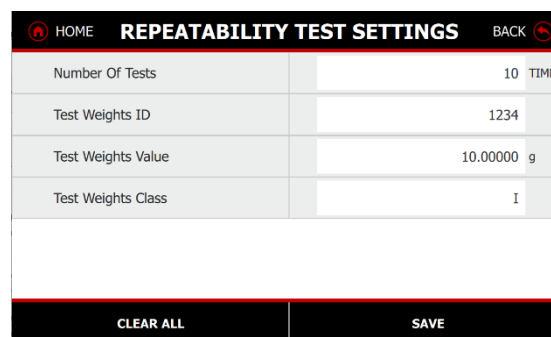
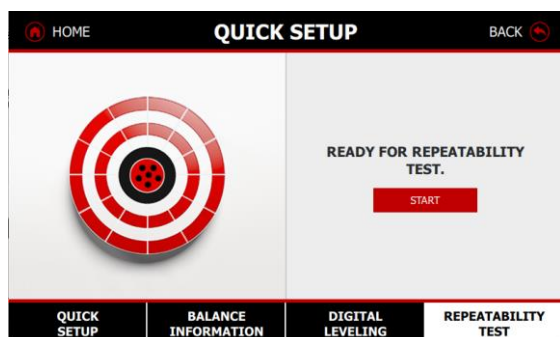

- Press Save button to store all the settings.

### Step 2: Perform repeatability Test

- Place the balance in a stable environment and press Zero or Tare before starting.
- Press the Start button to place weights on the pan one by one.
- During the testing, do not tare or zero the pan, as the load will calculate all factors to produce accurate results.
- Example: After 10 tests with 10-gram weights, the balance will automatically display the repeatability test results.

### Step 3: Review report

- Press the View History button to review the last repeatability test result.
- Press the Print button to print the repeatability test report and or export it to a PDF file when a USB flash drive is inserted.
- Press Min-weight to display the reference minimum weight.

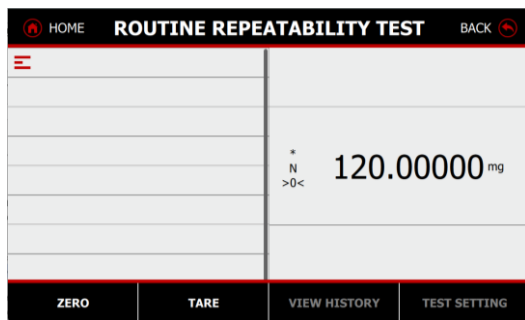

## 5.4 Calibration

Explorer EXR Balances build Automatic Calibration System. offer a choice of three calibration methods: Calibration Method: Automatic Calibration, Internal Calibration (User triggered), Span Calibration, and 3000 x Calibration History/ Log.

- Calibration is accomplished with the internal calibration mass. Internal calibration can be performed at any time, provided the balance has warmed up to operating temperature and is level.
- In the main screen, the user can press CAL button to perform Internal Calibration.

**Note:** Do not disturb the balance during any calibration.

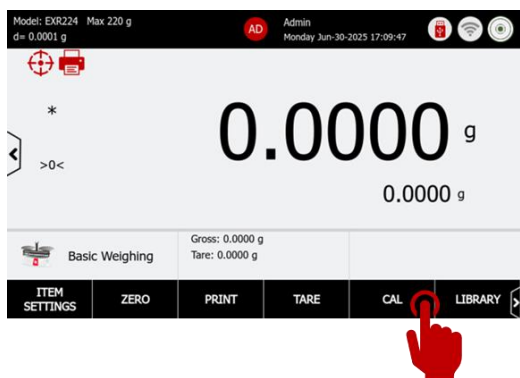



### 5.4.1 Calibration Settings

The Calibration Setting is used to configure the calibration method and the calibration points for Span Calibration.

- Internal Calibration
  - On/Off Internal Calibration function
  - Default setting: ON
- Automatic Calibration
  - When Internal Calibration is set ON, the balance performs a self calibration:
  - The environment temperature change of 1.5°C
  - Every 3 hours for Semi-Micro model, Every 11 hours for rest of the models
  - Default setting: ON
- AutoCal Interval Hours: The automatic calibration is triggered by a time-based schedule.
  - Enable the Automatic Calibration function, user can defined the time.
  - The value can be set from 3-11 hours.
- Print Automatic Calibration
  - Enable the auto-print function. When the AutoCal is completed, the balance will send the calibration report to the PC or printer if connected.
- Span Calibration Points
  - The Span calibration uses two calibration points, one at zero load and the other at specified full load (span). For detailed calibration mass information please see the specification tables in section 9.
  - Refer to model specification table 11.2 for factory default span calibration points.
  - The user can defined the Span Calibration weights value by preset value and alternative weights.
    - ◆ Alternative Span Calibration Points: The weight value between 20% and 100% of the maximum balance capacity.

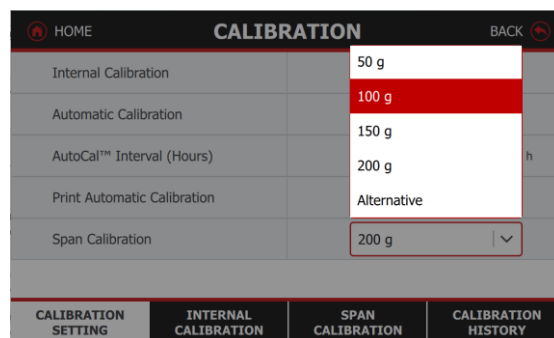
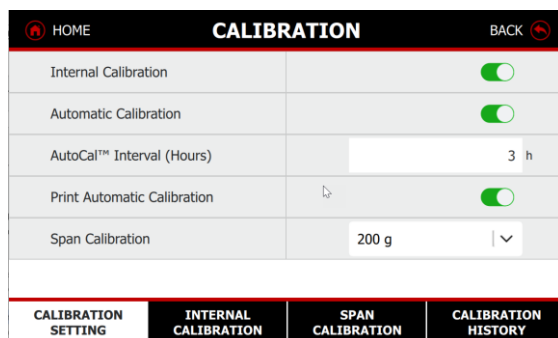

Note: Time out is 40 seconds

### 5.4.2 Internal Calibration

Internal calibration is performed using the built-in calibration weight. This process can be initiated at any time, as long as the balance has reached its operating temperature and balance is properly leveled.

### Step 1: Start Calibration Process

- Press **Internal Calibration** tab, and press **Start**. The Balance will begin to calibrate. To cancel at any time, press **Cancel**.

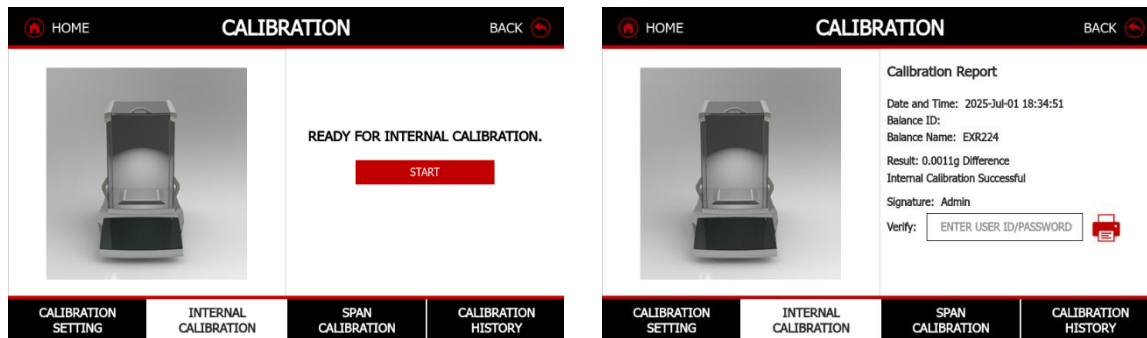

### Step 2: Verify the calibration result

- After calibration, place the test mass on the pan and verify that the mass value now matches the displayed value. If not, repeat the procedure until the reading agrees with the test mass.

### Step 3: Calibration Report

- When the calibration process is completed, the balance will generate a calibration report that includes the following information:
  - Date/Time: Week, Date and Time
  - Balance ID: Balance series number
  - Balance Name: Balance Model
  - Result: Successful or Failed
  - Signature: User ID (when the user management is set on)
  - Verified by: User can input the User ID/ Password
- Press the Print button to print the calibration report, and the results will be saved in the Calibration History for future reference.

## 5.4.3 Span Calibration

### Step 1: Select Span Calibration weights value in the Calibration Setting

- Different capacity balances have different Span Calibration points. Users can choose the best Span Calibration points by using either the full load or half load of the balance's capacity.
- If the weights are certified with a tolerance value, users can input an **Alternative Weight Value** before starting the Span Calibration process.

Calibration Masses Table

Model	Span Calibration Points	Weight Class	
EXR125D; EXR125DM	25g, 50g, 75g, 100g	ASTM Class 1	OIML E2
EXR125; EXR125M	25g, 50g, 75g, 100g	ASTM Class 1	OIML E2
EXR225D; EXR225DM	50g, 100g, 150g, 200g	ASTM Class 1	OIML E2
EXR124	25g, 50g, 75g, 100g	ASTM Class 1	OIML E2
EXR224	50g, 100g, 150g, 200g	ASTM Class 1	OIML E2
EXR324, M, N	100g, 150g, 200g, 300g	ASTM Class 1	OIML E2
EXR223	50g, 100g, 150g, 200g	ASTM Class 1	OIML E2
EXR423	100g, 200g, 300g, 400g	ASTM Class 1	OIML E2
EXR623	300g, 400g, 500g, 600g	ASTM Class 1	OIML E2
EXR1203, M, N	400g, 600g, 800g, 1000g	ASTM Class 1	OIML E2
EXR2202	500g, 1000g, 1500g, 2000g	ASTM Class 1	OIML E2
EXR4202	1000g, 2000g, 3000g, 4000g	ASTM Class 1	OIML E2
EXR6202	2000g, 3000g, 4000g, 6000g	ASTM Class 1	OIML E2
EXR8202	2000g, 4000g, 6000g, 8000g	ASTM Class 1	OIML E2
EXR10202, M, N	6000g, 8000g, 10,000g, 12,000g	ASTM Class 1	OIML E2
EXR6201	2000g, 3000g, 4000g, 6000g	ASTM Class 2	OIML F1
EXR8201	2000g, 4000g, 6000g, 8000g	ASTM Class 2	OIML F1
EXR10201, M	2500g, 5000g, 7500g, 10,000g	ASTM Class 2	OIML F1

**Step 1: Start Calibration Process**

- Press **Span Calibration tab**, and press **Start**, the Balance will begin to calibrate. To cancel at any time, press **Cancel**.
- Follow the guide message to place the weights on the pan and wait until the balance is stable.

**Step 2: Verify the calibration result**

After calibration, place the test mass on the pan and verify that the mass value now matches the displayed value. If not, repeat the procedure until the reading agrees with the test mass.

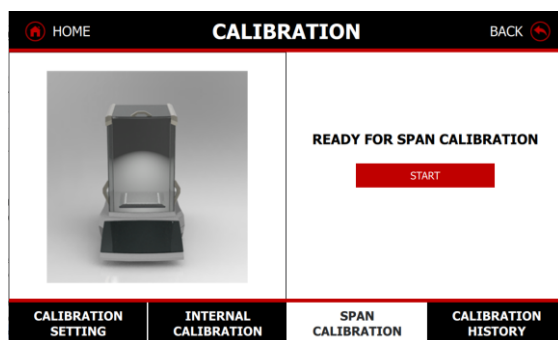

**Step 3: Calibration Report**

- When the calibration process is completed, the balance will generate a calibration report that includes the following information:
  - Date/Time: Week, Date and Time
  - Balance ID: Balance series number
  - Balance Name: Balance Model
  - Result: Successful or Failed, and Difference deviation is compared with latest calibration value.
  - Signature: User ID (when the user management is set on)
  - Verified by: User can input the User ID/ Password

- Press the Print button to print the calibration report, and the results will be saved in the Calibration History for future reference.

### 5.4.4 Calibration History

The balance can store up to 3000 x Calibration History/ Log whenever the calibration is performed.

The total memory is displayed as xx/xx% in the upper right corner. At any time, users can export the calibration records to a PDF file when a USB flash drive is inserted.

**Note:** When the user activates the **System Log** function, the calibration history will be recorded as **Calibration Log** in the Service Menu.

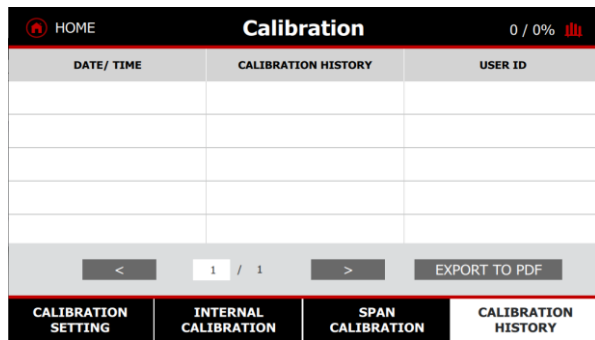

## 5.5 Balance Setup

Enter this sub-menu to customize Balance functionality

### 5.5.1 Language

Set the language for menu display and pop-up messages. The default setting is configured based on the country of sale. The 13 available languages are English, German, French, Spanish, Italian, Polish, Czech, Hungarian, Portuguese, Chinese, Japanese, Korean, and Turkish.

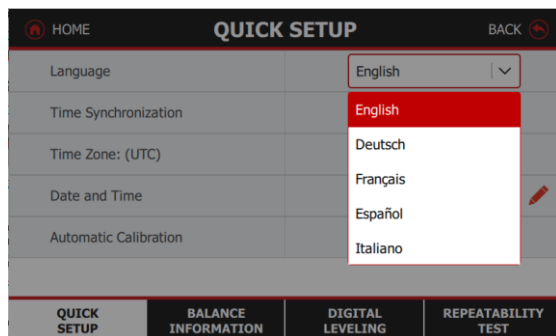

### 5.5.2 Time Synchronization/ Network Server

The new balance features Synchronization with Network (NTP function) which can use consistent time and data from the local network. The NTP system supports DNS domain name resolution.

- When you input the address of a public domain server, it will automatically convert it into an IP address. Here are some examples of NTP public time server address
  - “0.europe.pool.ntp.org” when the location is in Europe
  - “cn.ntp.org.cn” for China
  - “0.us.pool.ntp.org” for the US

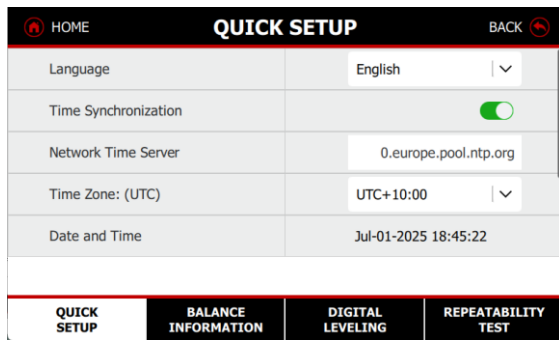

### 5.5.3 Date and Time

If you are offline using the balance, the new date/time setting fulfill your documentation needs with UTC time zone and customized the time format MMM-DD-YY HH-MM-SS and working weekdays setting.

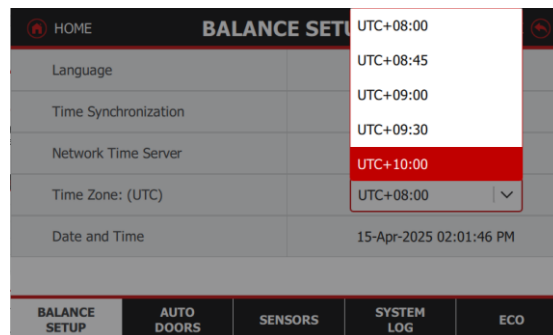

### 5.5.4 Balance Name

Set the balance identification. Alphanumeric settings up to 25 characters are available. The default setting is the model name of the balance

### 5.5.5 Change Password

- Change the password for the currently logged-in user. The Password Policy is defined in User Management:
- Option 1: Alphanumeric password containing 8 to 10 characters, combining letters and numbers.
- Option 2: Numeric password containing up to 25 characters.

See detail in section of User Management

Note: If you forget your password, please contact Ohaus or your local Ohaus dealer for assistance.

### 5.5.6 Filter Level

Set the amount of signal filtering: 1, 2, 3, 4, 5 (default), 6, 7, 8, 9. The higher the number means slower the stabilization time with more stability.

### 5.5.7 Stability Indicator Range

Set the amount the reading can vary while the stability symbol remains on.

- 0.25 = 0.25 stability factor
- 0.5 = 0.5 stability factor
- **1 = 1 stability factor (default)**
- 2 = 2 stability factor
- 3 = 3 stability factor
- 4 = 4 stability factor

### 5.5.8 Auto Zero Tracking

Set the automatic zero tracking functionality.

- Off = disabled.
- 0.5 d = display maintains zero up to a drift of 0.5 graduation per second
- 1 d = display maintains zero up to a drift of 1 graduation per second.
- 3 d = display maintains zero up to a drift of 3 graduations per second.

Note: When Legal for Trade is set to ON, the AZT setting is forced to 0.5 D.

The OFF setting is still available. The setting is locked at the current setting when the Legal for Trade switch is set to the ON position.

### 5.5.9 Gross Indicator

Set the symbol displayed for gross weights.

- Off = Disabled
- GROSS = the G symbol is displayed.
- BRUTTO = the B symbol is displayed.

The setting is locked at the current setting when the Legal for Trade switch is set to the ON position.

### 5.5.10 Graduation

Set the displayed readability of the balance.

- 1d = standard readability.
- 10d = readability is increased by a factor of 10.

For example, if the standard readability is 0.01g, selecting 10 Divisions will result in a displayed reading of 0.1g.

The setting is locked at the current setting when the Legal for Trade switch is set to the ON position.

### 5.5.11 Approved Mode

Use this menu to set the Legal for Trade mode.

- OFF = standard operation.
- ON = operation complies with Weights and Measures regulations.

Note:

- The security switch must be in the locked position to set Legal for Trade to ON.
- When Legal for Trade is set to ON, the menu settings are affected as follows:

■ **Calibration Menu:**

- ◆ Automatic Calibration is set to ON and the menu is hidden. Internal Calibration is available, while all other functions are concealed.
- ◆ For EXR...N... models: Automatic Calibration will be locked at its current setting.

If you set Internal Calibration to be ON before you turn on Approved Mode, Internal Calibration menu will still be available. If you set Internal Calibration to be OFF before you turn on Approved Mode, Internal Calibration menu will be locked.



■ **Balance Setup Menu:**

- ◆ Auto Zero Tracking is limited to 0.5 Division and OFF.
- ◆ Auto Tare and Gross Indicator are locked.
- ◆ Graduations is forced to 1 Division and the menu item is hidden.
- ◆ For EX...N...models, graduations will be locked at its current setting.
  - Weighing Units menu: all units are locked at their current settings.

■ **Communication Menu:**

- ◆ Stable Weight Only is locked ON.
- ◆ For EX...N...models, auto print mode selections are limited to OFF, On Stability, and Interval. Continuous is not available. Numeric Value Only is locked OFF.

■ **Legal for Trade Switch:**

	Explorer EXR Analytical and Precision Balance
Position	
Unlock / Lock	

## 5.6 Sensor

There are 2 touchless sensors on the top of balance terminal.

When the user waves their hand over the sensor, the function will be activated, and a green light will flash for a second. The available settings are as follows: Print, Zero, Tare, Calibrate. If the sensor is not activated, the sensor light will be red.

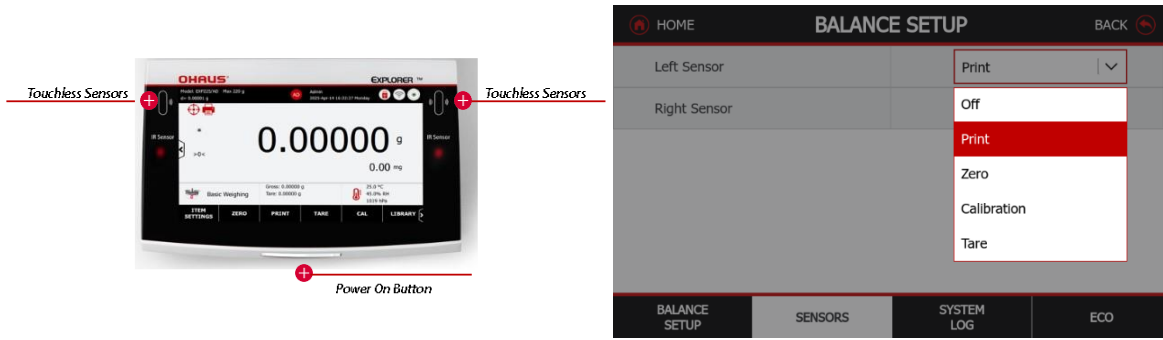

## 5.7 System Log

- All the changes made to the balance settings will keep records in system log file. e.g. every printed data, date/time change, balance setting changes, calibration actions, user log in/log out, user account create/edit/delete and etc. These system log files can be reviewed and exported as a PDF to a USB flash drive.
- Internal system log capacity of 100,000 entries records can be stored in balance memories. When the memories are full, a message will pop up for exporting the log files to a USB flash diver.
- System Log is saved in the Service Menu. See the detail function in section of Maintenance / System Log.

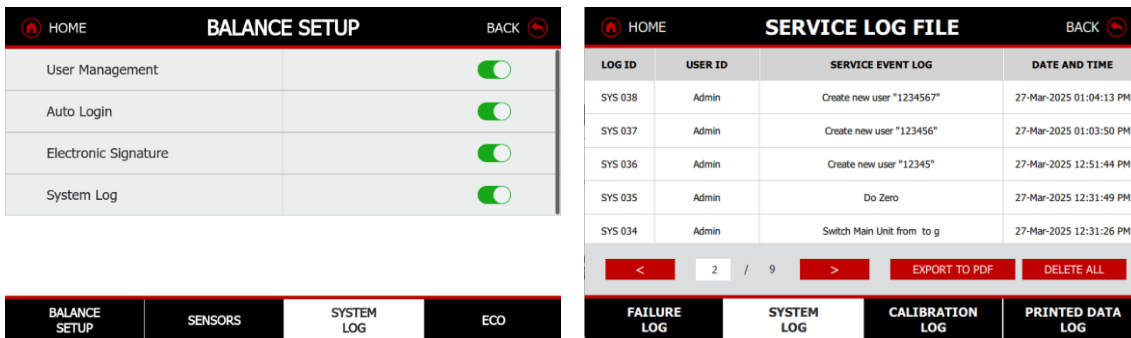

### Auto Login

- Auto login is beneficial for Admin users who have not set a password, as no login is required after pressing the standby button.
- Other users cannot use this function when user management is enabled.

### Electronic Signature

When the Electronic Signature feature is enabled, the User ID will be used in the printout field when the User ID content option is selected. For details, refer to the printout template in the Printing section.

### System Log

Users can enable or disable the System Log as needed. When it is deactivated, changes to the balance will not be recorded in the balance memory.

## 5.8 ECO

OHAUS places energy-saving design as one of its top priorities, evident in all of its laboratory weighing products which feature power-saving capabilities. As a leading laboratory manufacturer, this small step forward demonstrates our commitment to these important causes.

To be specific, OHAUS electronic balance has designed a three-tiered energy-saving strategy for laboratory use.

- **Off** means the touchscreen display will operate with default settings.



- **Auto Dim** means the display will shift to a darker shade when there is inactivity.
- **Auto Standby** indicates the machine will log itself off automatically.
- **Sleep Mode** indicates that the display will be turned off at a predetermined time, while only retaining the base operation power.

### 5.8.1 Power Saving

- When the user selects Auto Dim and Auto Standby, the ECO time will automatically be set to 20 minutes. Additionally, the brightness, volume, and light functions will be locked to conserve power.
- When the user selects Sleep mode, the ECO time will automatically be set to 0 minutes. Additionally, the brightness, volume, and light functions will be locked to conserve power.

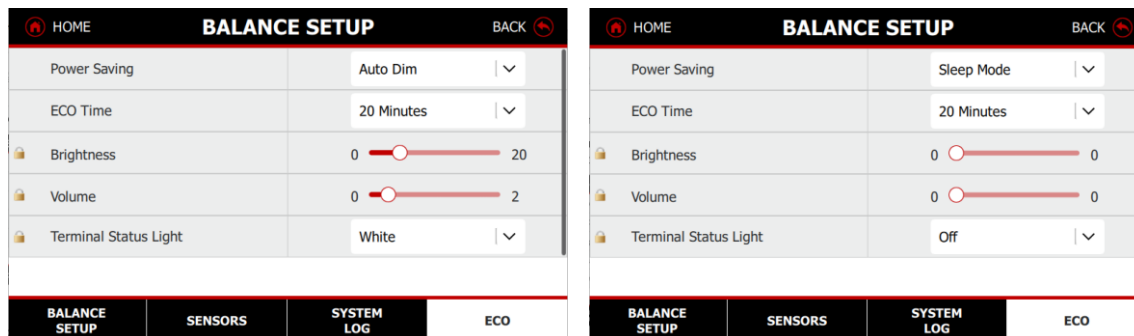

### 5.8.2 Brightness

Screen Brightness: Adjust the brightness from 0 to 100. Default value= 90

### 5.8.3 Volume

Adjust the volume from 0 to 20. Default value= 2

The Explorer EXR balance offers three sound options: a sound for click sound, successful actions, and an error sound.

### 5.8.4 Status lights

The lighting system can be customized into rainbow colors.

**Terminal Status Lights:** Users can change the light to different colors, such as Red, Pink, Yellow, Green, Cyan, Blue, and White.

## 5.9 User Management

The enhanced user management system enables administrators to create up to 200 user accounts, featuring four predefined roles. 4-level user management with an underdefined user group with access rights to the balance.

- Administrator (1)
- Supervisor (maximum of 20)
- 179 allocated to other roles like operator, log viewer, and group users

User Management: The User Name is generated from First Name and Last Name entries.

**Note:** The User ID is unique and cannot be changed once it is confirmed. This is especially important once you enable Electronic Signature.

The Group User function is designed to allow multiple users to share the same access permissions for balance settings.

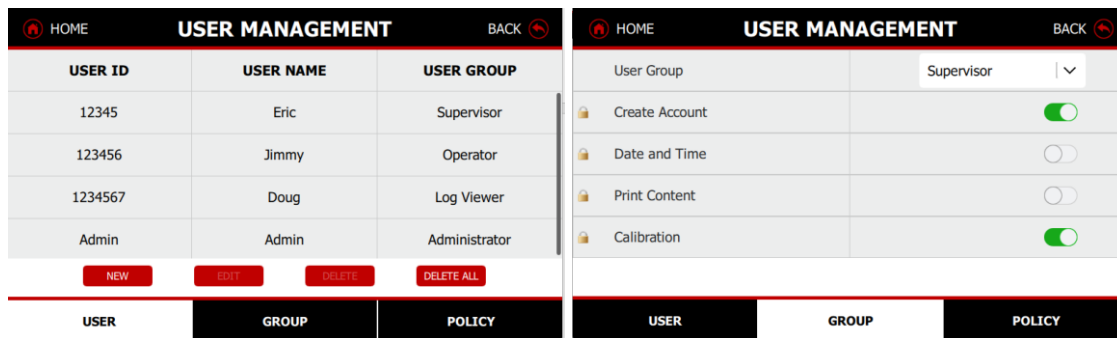

### 5.9.1 Create, Edit Delete a User

Admin can create, edit or delete Supervisor, Operator and Log Viewer, while Supervisor can create, edit or delete Operator. Operator and Log Viewer cannot access User management menu.

To create new users or edit or delete the current users

- Press to New button to add new user account, press Edit button to modify the user profiles
- Press delete or delete all user accounts by Administrator or Supervisor.

**Note:** Admin user cannot be deleted.

### 5.9.2 Preset User Role Accessibility

Settings	Administrator	Supervisor	Operator	Log Viewer (Auditor)	Group 1 User
Number of Users	1 person	20 people	Total 179 people		
Create Account/Delete Account	Create/Edit/Delete: Supervisor, Operator, Log viewer or Group user	Create/Edit Operator	x	x	√/ x
Date and Time	√	x	x	x	x
Print Content		√	x	x	√/ x
Calibration Function		√	x	x	√/ x
Weighing Units		√	√	x	√/ x
Library		√	New, Load, Edit/Delete (own)	x	√/ x
Factory Reset		√	x	x	√/ x
Routine Test		√	Allow to operate, not allow to change the Weights setting	x	√/ x
Balance Name		x	x	x	√/ x
Setup a Min-Weight		√	x	x	√/ x
Service Mode		x	x	x	√/ x
System Log	Read/Export/Delete	Read/Export	x	Read/Export	√ (Read/Export/Delete) / x
Graduation 1d/10d	√	√	x	x	√/ x

### 5.9.3 Group User Permissions

The Group User Permission function allows for the streamlined assignment of identical access permissions to multiple users. Four predefined groups are available: Administrator, Supervisor, Operator, and Log Viewer. In addition, a customizable Group 1 can be configured with unique access permissions.

All access options, except for Date and Time, Print Content, and Balance Name, are pre-configured and ready for use.

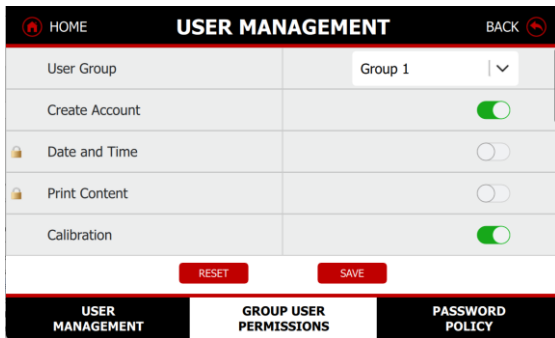

### 5.9.4 Password Policy

The system features alphanumeric password protection, which include the expiration days and password requirement.

#### Expiration Days:

To set when password will expire. There are three selections, 30 days, 60 days and 90 days.

#### Password Requirement:

- Option 1: Alphanumeric password containing 8 to 10 characters, combining letters and numbers.
- Option 2: Numeric password containing up to 25 characters.

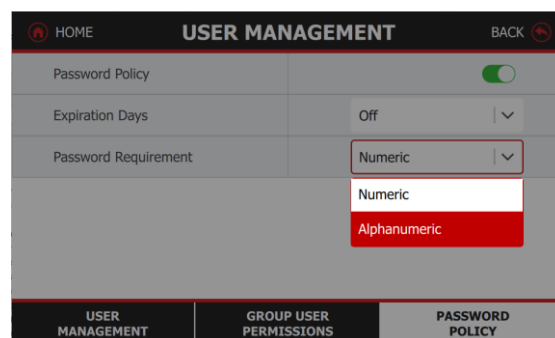
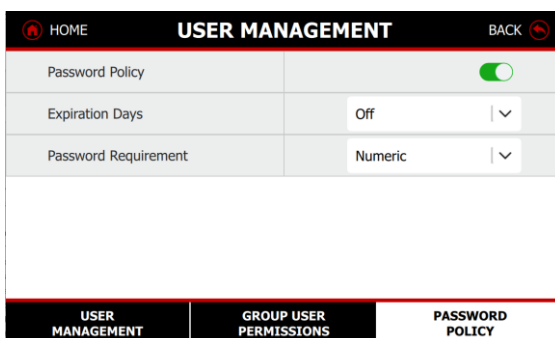

Note: If you forget your password, please contact Ohaus or your local Ohaus dealer for assistance.

### 5.10 Application Modes

The balance can be configured to operate in various Application modes.

Note: If an application mode does not appear in the list of available Applications, it must be enabled in the **Application Menu** touch Menu, then select Application Modes. The full list of modes appears. Touch the one you want to enable.

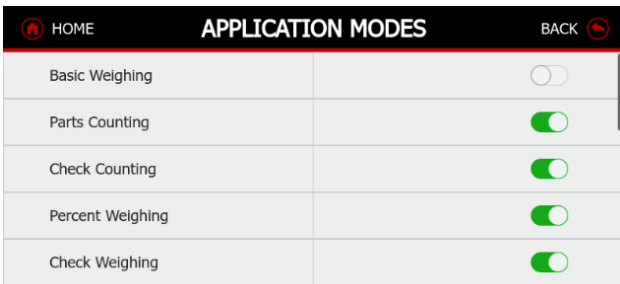
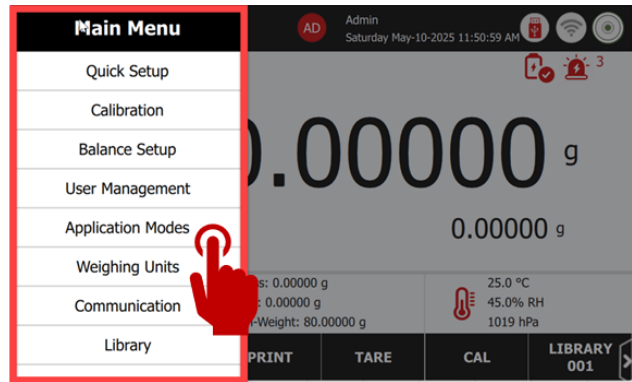
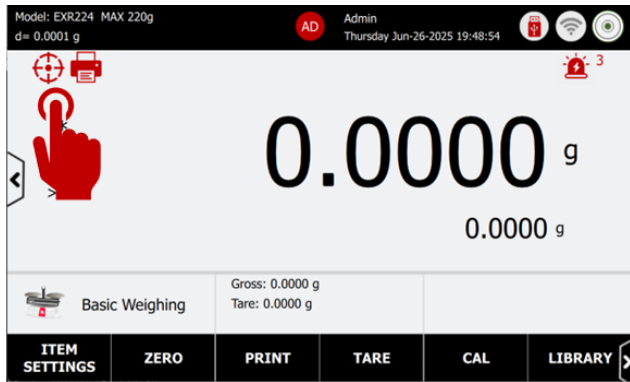

## 5.11 Weighing Units

The Explorer EXR balance can be configured to measure in a variety of weighing units, including 2 custom units. In the main screen, user can click “g” to switch an alternative weighing unit. The default unit is gram. In this menu, you can turn on/off the weighing unit according to the sample application.

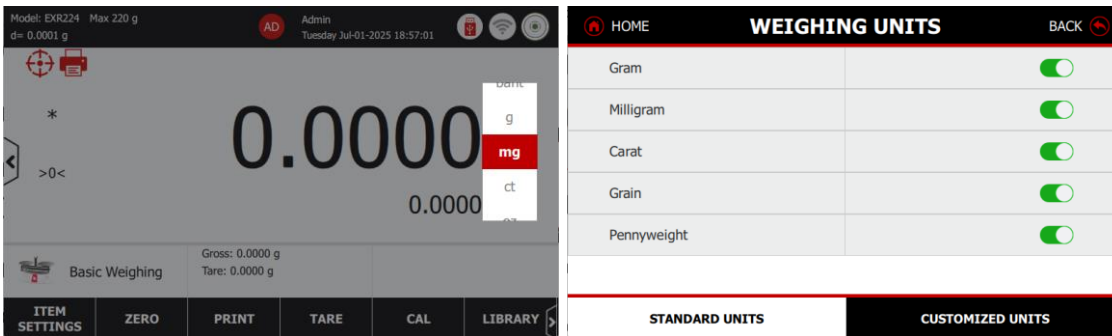

### Customized Units

Use each Customized Unit to display weight in an alternative unit of measure. The custom unit is defined using a conversion factor, where the conversion factor is the number of custom units per kilogram expressed in scientific notation (Factor x 10^Exponent). For example: To display weight in troy ounces (32.15075 troy ounces per kilogram) enter a Factor of 0.321508 and an Exponent of 2. Set the status.

- OFF = disabled
- ON = enabled

When Customized Unit is set to ON, the Unit Name Factor, Exponent and Least Significant Digit must be set.

WEIGHING UNITS		BACK
Customized Units 1		<input checked="" type="checkbox"/>
Unit Name		C1
Factor		1.0
Exponent	-3	v
Least Significant Digit	1	v

STANDARD UNITS      CUSTOMIZED UNITS

**Factor:** Set the conversion factor using the numeric keypad.

Settings of 0.00001 to 1.9999999 are available. The default setting is 1.000000

**Exponent:** Set the factor multiplier.

- 0 = multiply the Factor by 1 ( $1 \times 10^0$ )
- 1 = multiply the Factor by 10 ( $1 \times 10^1$ )
- 2 = multiply the Factor by 100 ( $1 \times 10^2$ )
- 3 = multiply the Factor by 1000 ( $1 \times 10^3$ )
- -3 = divide the Factor by 1000 ( $1 \times 10^{-3}$ )
- -2 = divide the Factor by 100 ( $1 \times 10^{-2}$ )
- -1 = divide the Factor by 10 ( $1 \times 10^{-1}$ )

**Least Significant Digit:** Set the graduation.

Settings of 0.00001, 0.00002, 0.00005, 0.0001, 0.0002, 0.0005, 0.001, 0.002, 0.005, 0.01, 0.02, 0.05, 0.1, 0.2, 0.5, 1, 2, 5, 10, 20, 50, 100, 200, 500 and 1000 are available.

**Note:** Least Significant Digit setting selections are dependent on the Factor and Exponent settings. Selections are limited.

## 5.12 Communication

The enhanced communication options include 2 USB Type-A ports, 1 USB Type-C port, 1 Ethernet LAN, 1 RS232, optional Bluetooth and Wi-Fi functionalities.

Additionally, the Explorer EXR balance supports HID (Human Interface Device) connection to a computer without requiring drivers. This enables users to use a mouse or keyboard to enter information such as User Name, USER ID, sample name, batch name, and other input details. The input field supports English and French characters, as well as numbers and symbols.



Enter this menu to define external communication methods and to set printing parameters. Data may be output to either a Printer or a PC

USB Type A	USB Type A – Connect to USB flash driver, RFID Reader, Barcode Scanner and Wi-Fi & Bluetooth Dongle
USB Type C	Connect Balance to PC
Ethernet Lan port	Connect Balance to PC
RS232	Connect Balance to Printer or PC

### 5.12.1 RS232

The RS232 port can connect to various peripheral devices such as printers, PCs, and label printers, each with different output formats. Ensure you select the appropriate peripheral device before transferring data.

- The connection settings for Printer and PC are as follows. Factory default settings are indicated in bold.
  - **Baud Rate** Set the baud rate (bits per second).
    - ◆ 1200 = 1200 bps
    - ◆ 2400 = 2400 bps
    - ◆ 4800 = 4800 bps
    - ◆ **9600 = 9600 bps**
    - ◆ 19200 = 19200 bps
    - ◆ 38400 = 38400 bps
    - ◆ 115200 = 115200 bps
  - **Transmission** Set the data bits, stop bit, and parity.
    - ◆ 7 EVEN 1 = 7 data bits, even parity, 7 ODD 1 = 7 data bits, odd parity
    - ◆ 7 NONE 1 = 7 data bits, no parity
    - ◆ **8 NONE 1 = 8 data bits, no parity**
    - ◆ 7 EVEN 2 = 7 data bits, even parity, 7 ODD 2 = 7 data bits, odd parity, 7 NONE 2 = 7 data bits, no parity, 8 NONE 2 = 8 data bits, no parity
  - **Handshake** Set the flow control method.
    - ◆ NONE = no handshaking
    - ◆ **XON-XOFF = XON/XOFF handshaking**
    - ◆ HARDWARE = hardware handshaking
  - **12V Output**
    - ◆ Enable the function to allow the RS232 port to output 12V, which supports the Bluetooth Adaptor.
    - ◆ Example: When users connect an SF40A/BT printer to the balance, they need to enable this function.

**Note:** The purpose of this switch is to prevent damage to external devices from the 12V output.

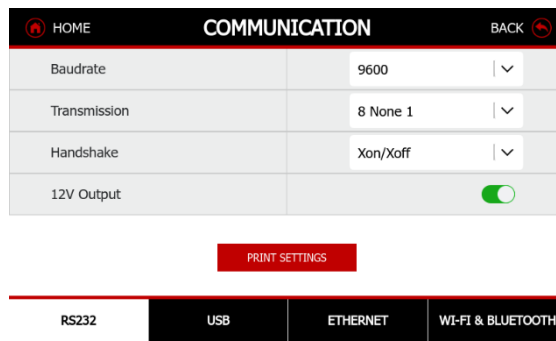
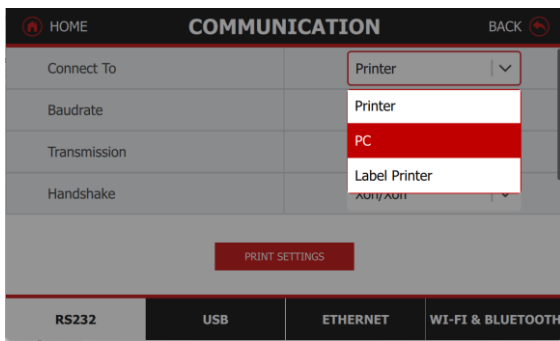

### 5.12.2 RS232 (DB9) Pin Connections

- Pin 2: Balance transmit line (TxD)
- Pin 3: Balance receive line (RxD)
- Pin 5: Ground signal (GND)
- Pin 7: Clear to send (hardware handshake) (CTS)
- Pin 8: Request to send (hardware handshake) (RTS)

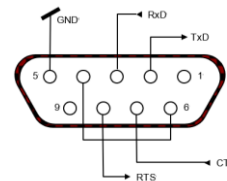

### 5.12.3 Connections for the Label Printer

All templates including the default one can be edited via OHAUS Label Designer. Please go to the website below to download the software. For how to use the software, please contact an authorized dealer to obtain the software's instructions. Overall, 5 label templates can be stored in the balance.

- When user select connect to Label Printing, the Label Template menu appears with default selection, "100mm x 75mm".
  - ◆ This function is compatible with any label printer using the ZPLII programming language. We recommend Zebra printer with RS232 port.
  - ◆ **#1-100mm x 75mm**, which is designed based on label size "100mm x 75mm". This template includes all basic information "Data/Time", "Sample ID", "Sample Name", "Batch ID", "Result", "Gross Weight", "Tare Weight", "Net Weight", and "User Name".
  - ◆ **#2-100mm x 10mm**, which is designed for small label size "100mm x 10mm" with weighing result only.
- To select another label template, touch the other numbers. Templates #3 - #5 are empty templates in Explorer EXR balance until they are edited by OHAUS label Designer and written to the balance.

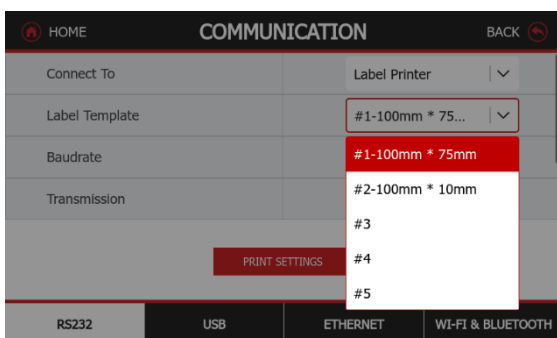

### 5.12.4 USB

The USB setting can individually setup the USB port to different setup appropriate peripheral device before transferring data.

- USB Type C connection with the balance to PC or Transfer Data Direct to Microsoft Excel.
- The format can be set in column or cell, see the detail print format in section of Print Setting 6.1

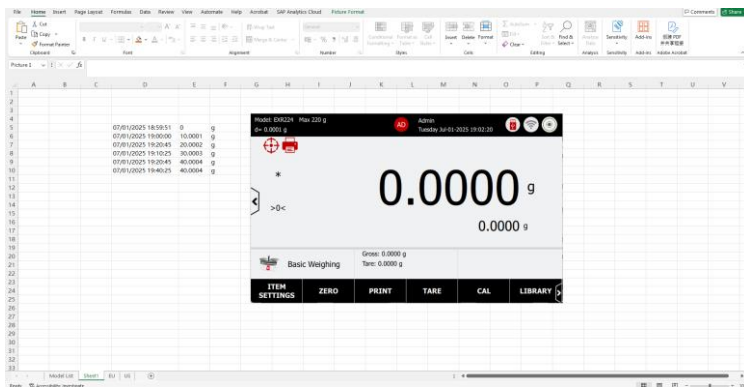

### 5.12.5 Ethernet

Using the Ethernet Port to connect to a Local Area Network. After successful connect ethernet cable with balance, user can setup the Ethernet options on the Communication Menu.

- **DHCP:** When connecting to a local area network (LAN) or a wireless network and the IP address is unknown, user can use DHCP to automatically obtain an IP address. Enable DHCP: the balance will automatically obtain IP, other ethernet settings will be locked.
- If you prefer to use a static IP address for the connection, you should disable DHCP and manually enter the IP address.

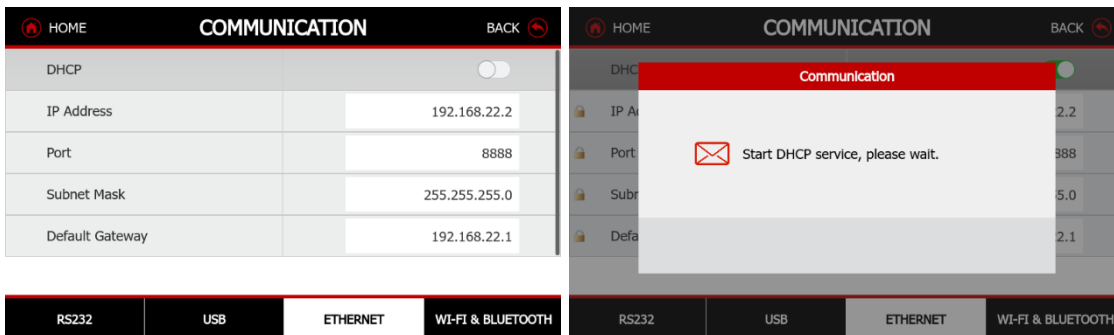

### 5.12.6 Wi-Fi & Bluetooth

The Explorer EXR balance uses LMB842 USB dongle to connect BT and Wi-Fi function.

- The LM842 USB Dongle complies with Bluetooth® 5.0 (Dual Mode) and IEEE 802.11ac WiFi Standards of operation. See detail compliance and specification of the LM842 USB Dongle in Section 11.1.

#### Bluetooth Connection

- The user needs to enter the Bluetooth name to pair with another PC's Bluetooth.
- Once the balance connects to a Bluetooth device, an icon will appear in the upper right corner of the main screen.
- MAC address is used to identify the same Bluetooth device name

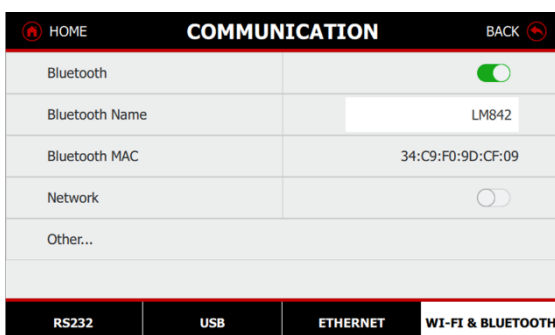



### Wi-Fi Connection

- First, the user needs to enable the Network function. The balance will then search for available networks.
- Enter the password to pair and connect to the Wi-Fi.
- If the network is not visible, the user can press the "Other..." button to manually add the network.
- Once the balance connects to a Wi-Fi, an icon will appear in the upper right corner of the main screen.

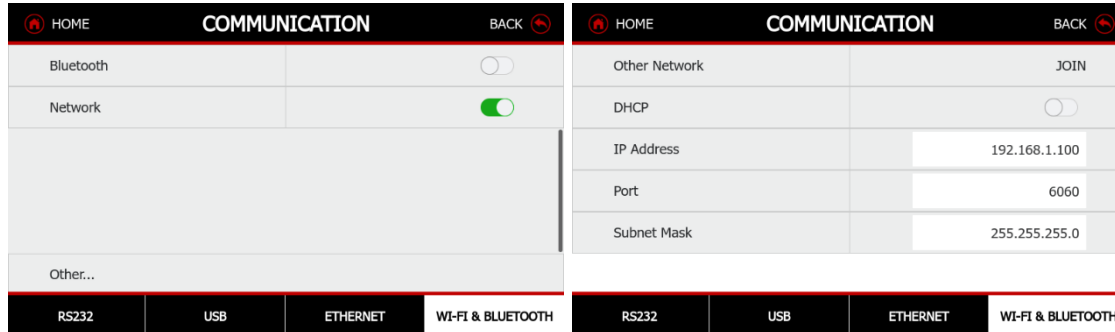

- **DHCP:** When connecting to a local area network (Wi-Fi) or a wireless network and the IP address is unknown, user can use DHCP to automatically obtain an IP address. Enable DHCP: the balance will automatically obtain IP, other ethernet settings will be locked.
- If you prefer to use a static IP address for the connection, you should disable DHCP and manually enter the IP address.

## 6 Print Settings

Users can configure this function individually based on their specific application requirements. The function allows users to select from the following settings:

- **Print Content:** Customize the content to be printed, including all desired results and titles along with the weighing value.
- **Connect to Printer:** Define the data to be sent to the printer.
- **Connect to PC:** Specify the data to be transmitted to the PC.
- **Data to Excel:** Format the layout of the data that is sent directly to Microsoft Excel.
- **Save to USB:** Determine how data is saved to a USB flash device, such as the data format and whether the process is manual or automatic.

**Note:** When the balance is turned on in the Legal For Trade mode, the print settings will immediately be changed to comply with relevant Weights and Measures Regulation, such as those of the International Organization of Legal Metrology (OIML), the National Type Evaluation Program (NTEP) and other local approves.

Refer to section 9.1 for detailed information on Legal for Trade Setting.

### 6.1 Print Content

Access this sub-menu to specify the content of the printed data. Users can toggle the content on or off. The Print Review function will directly provide a layout template based on the selected options. The selected content use for “Connect to PC”, “Connect to Printer”, “Save to USB” PDF file.

The available print contents:

- Select All
- Date and Time, Balance ID and Balance name
- User ID, First Name/ Last Name
- Project Name
- Application Mode
- Sample Name, Sample ID
- Batch ID, Lot ID
- Customized IDs
- Result
- Gross, Net, and Tare
- Signature Line
- Verified Line
- Feeds Lines (1, 4, 10)

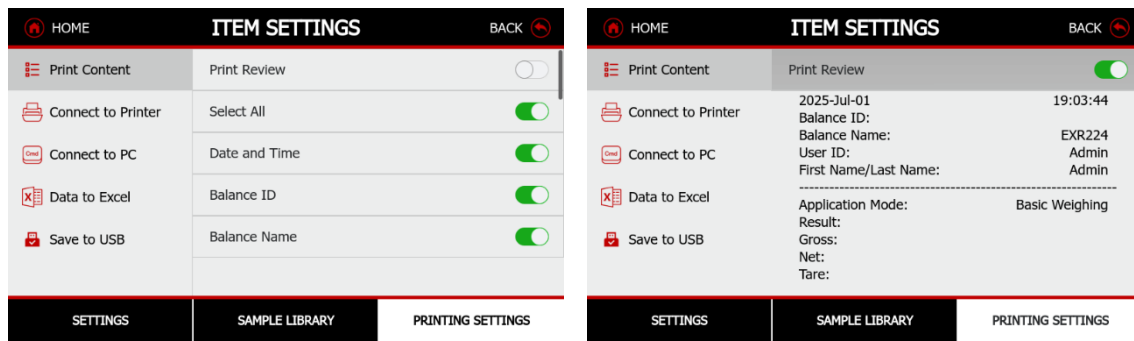

## 6.2 Connecting to a Printer

### Numeric Only

On = Print only the numeric weight value.

Off = Print all the weighing value that enabled in the Print Content.

### Single Header Only

When user turn it On, Header line will be printed only once 24 hours. The header line includes the following elements:

- Date and Time, Balance ID, and Balance Name
- Project Name
- Application Mode
- Sample Name, Sample ID
- Batch ID, Lot ID
- Customized IDs

### Manual Print

Stable only = Print only the stable value

All values = Print all values

### Auto Print

Off = disabled

On Stability = printing occurs each time the stability criteria are met.

Interval = printing occurs at the defined time interval (1 to 3600 seconds)

Continuous = printing occurs continuously.

When ON STABLE is selected, set the conditions for printing.

- LOAD = Prints when the displayed load is stable.
- LOAD ZERO = Prints when the displayed load or zero reading is stable.
- When Approved Mode is On, users can only print stable only values

## 6.3 Connecting to a PC

### Output Format

Users can choose the output format based on various output strings.

- OHAUS

- SICS = MT-SICS
- ST =ST-SICS (10)

#### Manual Print

Stable only = Print only the stable value

All values = Print all values

#### Auto Print

Off = disabled

On Stability = printing occurs each time the stability criteria are met.

Interval = printing occurs at the defined time interval (1 to 3600 seconds)

Continuous = printing occurs continuously.

When ON STABLE is selected, set the conditions for printing.

- LOAD = Prints when the displayed load is stable.
- LOAD ZERO = Prints when the displayed load or zero reading is stable.
- When Approved Mode is On, users can only print stable only values

## 6.4 Data to Excel

The balance supports HID (Human Interface Device) connection to a computer without the need for drivers.

The format:

DD-MMM-YYYY	Weight	Units
15-May-2025	100.0000	g

#### Manual Print

Stable only = Print only the stable value

All values = Print all values

#### Auto Print

Off = disabled

On Stability = printing occurs each time the stability criteria are met.

Interval = printing occurs at the defined time interval (1 to 3600 seconds)

Continuous = printing occurs continuously.

When ON STABLE is selected, set the conditions for printing.

- LOAD = Prints when the displayed load is stable.
- LOAD ZERO = Prints when the displayed load or zero reading is stable.
- When Approved Mode is On, users can only print stable only values

#### Text to

Direct to Excel Function:

- Column: Print all data into a single column in Microsoft Excel.
- Cell: Print all data into a single cell in Microsoft Excel.

## 6.5 Save to USB

- Off = Disable save to USB
- Manual = Save to USB manually
- Auto = Auto save to USB
  - Once the user has set the auto-print interval time, the data will be sent to the USB flash drive at the specified intervals.
  - The PDF format is not allowed when in Auto save mode
- Format
  - PDF
  - CSV

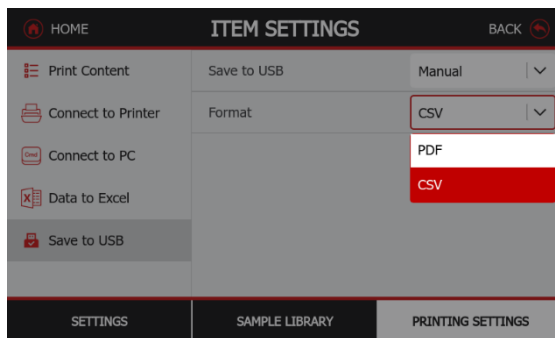

6.5.1 Application Print Out Template

Basic Weighing		Parts Counting		Check Counting	
2025-Apr-08	09:31:46	2025-Apr-08	10:13:34	2025-Apr-08	10:17:42
Balance ID:		Balance ID:		Balance ID:	
Balance Name:		Balance Name:		Balance Name:	
User ID:	Admin	User ID:	Admin	User ID:	Admin
First Name/Last Name:	Admin	First Name/Last Name:	Admin	First Name/Last Name:	Admin
Project Name:	PN058	Project Name:	PN070	Project Name:	PN081
-----		-----		-----	
Application Name:	Basic Weighing	Application Name:	Parts Counting	Application Name:	Check Counting
Sample Name:	SN058	Sample Name:	SN070	Sample Name:	SN081
Sample ID:	S058	Sample ID:	S070	Sample ID:	S081
Batch ID:	B058	Batch ID:	B070	Batch ID:	B081
Lot ID:	L058	Lot ID:	L070	Lot ID:	L081
Customer ID1:	C1	Customer ID1:	C1	Customer ID1:	C1
Customer ID2:	C2	Customer ID2:	C2	Customer ID2:	C2
Customer ID3:	C3	Customer ID3:	C3	Customer ID3:	C3
Customer ID4:	C4	Customer ID4:	C4	Customer ID4:	C4
Customer ID5:	C5	Customer ID5:	C5	Customer ID5:	C5
Customer ID6:	C6	Customer ID6:	C6	Customer ID6:	C6
Customer ID7:	C7	Customer ID7:	C7	Customer ID7:	C7
Customer ID8:	C8	Customer ID8:	C8	Customer ID8:	C8
Customer ID9:	C9	Customer ID9:	C9	Customer ID9:	C9
Customer ID10:	C10	Customer ID10:	C10	Customer ID10:	C10
Result:	3.5275	Result:	25 PCS	Result:	74 PCS
oz N		Gross:	78.48 g	Status:	Accept
Gross:	6.2960	Net:	78.48 g N	Gross:	178.49 g
oz		Tare:	0.00 g T	Net:	178.49 g N
Net:	3.5275 oz N			Tare:	0.00 g T
Tare:	2.7690 oz T	Library:	Library 070		
		APW:	3.124 g	Library:	Library 081
Library:	Library 058	Samples:	10 PCS	APW:	2.412 g
				Samples:	81 PCS
Signature: _____		Signature: _____		Over:	254 PCS
				Under:	51 PCS
Verify By: _____		Verify By: _____			
				Signature: _____	
				Verify By: _____	

Percent Weighing		Check Weighing		Dynamic	
2025-Apr-08	13:30:04	2025-Apr-08	13:33:25	2025-Apr-08	13:36:21
Balance ID:		Balance ID:		Balance ID:	
Balance Name:		Balance Name:		Balance Name:	
User ID :	Admin	User ID:	Admin	User ID:	Admin
First Name/Last Name:		First Name/Last Name:		First Name/Last Name:	
Project Name:	PN010	Project Name:	PN028	Project Name:	PN055
-----		-----		-----	
Application Name:	Percent Weighing	Application Name:	Check Weighing	Application Name:	Dynamic Weighing
Sample Name:	SN010	Sample Name:	SN028	Sample Name:	SN055
Sample ID:	S010	Sample ID:	S028	Sample ID:	S055
Batch ID:	B010	Batch ID:	B028	Batch ID:	B055
Lot ID:	L010	Lot ID:	L028	Lot ID:	L055
Customer ID1:	C1	Customer ID1:	C1	Customer ID1:	C1
Customer ID2:	C2	Customer ID2:	C2	C2:	C2
Customer ID3:	C3	Customer ID3:	C3	Customer ID3:	C3
Customer ID4:	C4	Customer ID4:	C4	Customer ID4:	C4
Customer ID5:	C5	Customer ID5:	C5	Customer ID5:	C5
Customer ID6:	C6	Customer ID6:	C6	Customer ID6:	C6
Customer ID7:	C7	Customer ID7:	C7	Customer ID7:	C7
Customer ID8:	C8	Customer ID8:	C8	Customer ID8:	C8
Customer ID9:	C9	Customer ID9:	C9	Customer ID9:	C9
Customer ID10:	C10	Customer ID10:	C10	Customer ID10:	C10
Result:	361.69 %	Result:	Accept	Result:	367.00 g
Gross:	198.93 g	Gross:	198.92 g	Gross:	198.93 g
Net:	198.93 g N	Net:	198.92 g N	Net:	198.93 g N
Tare:	0.00 g T	Tare:	0.00 g T	Tare:	0.00 g T
Library:	Library 010	Library:	Library 028	Library:	Library 055
Reference Weight:	550.00 g	Over Limit:	214.25 g	Averaging Time:	3 seconds
Reference Factor:	10.0 %	Under Limit:	12.54 g	Signature:	_____
Difference Weight:	143.93 g	Signature:	_____	Verify By:	_____
Difference Factor:	261.69 %	Verify By:	_____		
Signature:	_____				
Verify By:	_____				

Totalization		Formulation		Differential	
2025-Apr-08	15:11:42	2025-Apr-08	16:30:04	2025-Apr-08	19:58:46
Balance ID:		Balance ID:		Balance ID:	
Balance Name:		Balance Name:		Balance Name:	
User ID:	Admin	User ID:	Admin	User ID:	Admin
First Name/Last Name:		First Name/Last Name:		First Name/Last Name:	
Project Name:	PN072	Project Name:		Project Name:	
-----		-----		-----	
Application Name:	Totalization	Application Name:	Formulation	Application Mode:	Differential
Sample Name:	SN072	Result:	199.09 g N	Result:	3.89[3] g N
Sample ID:	S072	Gross:	299.09 g	Gross:	18.42[0] g
Batch ID:	B072	Net:	199.09 g N	Net:	3.89[3] g N
Lot ID:	L072	Tare:	100.00 g T	Tare:	14.52[7] g T
Customer ID1:	C1				
Customer ID2:	C2	Recipe:	Recipe 001	Start Time:	2025-Apr-08 19:57:07
Customer ID3:	C3	Item Name	Item Weight	End Time:	2025-Apr-08 19:58:41
Customer ID4:	C4	Item 1	100.00 g		
Customer ID5:	C5	Item 2	199.08 g	Reciprocal Proportion	On
Customer ID6:	C6			Absolute Value	On
Customer ID7:	C7	Start Time:	12-26-2024 16:29:44		
Customer ID8:	C8	End Time:	12-26-2024 16:30:01	Item Name:	ITEM1
Customer ID9:	C9	-----Sample Data-----		Initial Weight:	0.766 g
Customer ID10:	C10	Item Name:	Item 1	Final Weight:	0.760 g
Result:	278.33 g	Target Weight:	100.00 g	Difference Weight:	0.006 g
Gross:	0.00 g	Actual Weight:	100.00 g	Different Percent:	0.8 %
Net:	0.00 g N	Difference:	0.00 %		
Tare:	0.00 g T			Item Name:	ITEM2
		Item Name:	Item 2	Initial Weight:	1.528 g
Library:	Library 072	Target Weight:	199.08 g	Final Weight:	1.534 g
Start Time:	12-26-2024 15:08:29	Actual Weight:	199.08 g	Difference Weight:	0.006 g
End Time:	12-26-2024 15:11:42	Difference:	0.00 %	Different Percent:	0.4 %
-----Sample Data (g)-----		Total Weight:	299.08 g	Item Name:	ITEM3
'1:	198.93	Signature: _____		Initial Weight:	2.292 g
'2:	19.85			Final Weight:	2.325 g
'3:	19.86	Verify By: _____		Difference Weight:	0.033 g
'4:	19.87			Different Percent:	1.4 %
'5:	19.88				
Samples:	5			Item Name:	ITEM4
Average:	55.67 g			Initial Weight:	3.094 g
Maximum:	198.93 g			Final Weight:	3.110 g
Minimum:	19.85 g			Difference Weight:	0.016 g
Range:	179.08 g			Different Percent:	0.5 %
Standard Deviation:	71.63 g			Item Name:	ITEM5
Relative Deviation(std%):	128.68 %			Initial Weight:	3.871 g
Signature: _____				Final Weight:	3.893 g
Verify By: _____				Difference Weight:	0.022 g
				Different Percent:	0.6 %
				Signature: _____	
				Verified By: _____	



Density Determination		Peak Hold	
2025-Apr-08	20:01:25	2025-Apr-08	20:25:41
Balance ID:		Balance ID:	
Balance Name:		Balance Name:	
User ID:	Admin	User ID:	Admin
First Name/Last Name:		First Name/Last Name:	
-----		-----	
Application Mode:	Density Determination	Application Mode:	Peak Hold
Result:	7.435 g/cm?	Result:	355.512 g
Gross:	19.44[1] g	Gross:	0.000 g
Net:	4.91[4] g N	Net:	0.000 g N
Tare:	14.52[7] g T	Tare:	0.000 g T
Weight in air.:	5.67[4] g	On Stability:	No
Weight in liquid.:	4.91[3] g	Signature: _____	
Auxiliary liquid.:	Water	Verified By: _____	
Liquid Density:	0.99823 g/cm <sup>3</sup>		
Water Temp.:	20.0 °C		
Porous Material:	Off		
Signature: _____			
Verified By: _____			

## 6.6 Printout Examples

Here are the examples for each application are displayed with all items enabled in the Print Content menu. The default values for Header lines 1-5 are also indicated.

Notes:

- When the user management and electronic signature are active, the User ID will display in the Signature Line. The electronic signature is disabled by default.
- When a library is activated, "Library Name:" will appear below "Application" in the printout.

6.6.1 Calibration Report Template

Internal Calibration	Span Calibration	Repeatability Test		
Calibration Report -----Internal Calibration----- Date and Time: 2025-May-12 10:34:02 Balance ID: Balance Name: EXR224/AD Result: 0.0000g Difference Internal Calibration Successful Signature: User ID Verified By: _____	Calibration Report -----Span Calibration----- Date and Time: 2025-May-12 10:34:02 Balance ID: Balance Name: EXR224/AD Result: 0.0000g Difference Span Calibration Successful Signature: User ID Verified By: _____	Routine Test:      Repeatability Test Date:                      2025-Apr-11 Start Time:                19:13:45 End Time:                    19:15:52 Test Weights ID: Test Weights Value:      25.00000 g Test Weights Class: Test Result: Number   Zero Load      Full Load 1            0.00000 g            25.00496 g 2            -0.00002 g            25.00262 g 3            -0.00013 g            25.00063 g 4            -0.00006 g            25.01753 g 5            0.00001 g            25.00375 g 6            0.00002 g            25.00014 g SD (Span):                0.006441 g  Signature: _____ Verified By: _____		

6.6.2 Batch Printing Output

Printout	Export to PDF Template																																															
User ID: Admin First Name/Last Name: Admin Sample Name: Sample ID: Customized ID:  -----Sample Data----- <table border="0"> <tr><td>1</td><td>25.00120 g</td><td>23:19:39</td></tr> <tr><td>2</td><td>24.99835 g</td><td>23:19:46</td></tr> <tr><td>3</td><td>25.00070 g</td><td>23:19:47</td></tr> <tr><td>4</td><td>25.00087 g</td><td>23:19:48</td></tr> <tr><td>5</td><td>25.00106 g</td><td>23:19:49</td></tr> </table> Signature: _____  Verified By: _____	1	25.00120 g	23:19:39	2	24.99835 g	23:19:46	3	25.00070 g	23:19:47	4	25.00087 g	23:19:48	5	25.00106 g	23:19:49	<p style="text-align: center;">EXPLORER BALANCE <span style="float: right;">PAGE 1</span></p> <hr/> <p style="text-align: center;"><b>BATCH PRINTING RESULTS</b></p> <hr/> <p>Date and Time:2025-Jul-08 09:25:40                      Balance ID:                      Balance Name:EXR224                      User ID:Admin                      First Name/Last Name:Admin                      Sample Name:                      Sample ID:                      Customized ID:</p> <hr/> <table border="0"> <thead> <tr> <th style="text-align: left;">SAMPLE ID</th> <th style="text-align: left;">WEIGHT</th> <th style="text-align: left;">DATE</th> <th style="text-align: left;">TIME</th> </tr> </thead> <tbody> <tr><td>001</td><td>0.0000 g</td><td>2025-Jul-08</td><td>09:25:26</td></tr> <tr><td>002</td><td>50.0024 g</td><td>2025-Jul-08</td><td>09:25:33</td></tr> <tr><td>003</td><td>50.0015 g</td><td>2025-Jul-08</td><td>09:25:34</td></tr> <tr><td>004</td><td>50.0013 g</td><td>2025-Jul-08</td><td>09:25:35</td></tr> <tr><td>005</td><td>50.0011 g</td><td>2025-Jul-08</td><td>09:25:35</td></tr> <tr><td>006</td><td>50.0010 g</td><td>2025-Jul-08</td><td>09:25:36</td></tr> <tr><td>007</td><td>50.0011 g</td><td>2025-Jul-08</td><td>09:25:37</td></tr> </tbody> </table> <hr/> <p style="text-align: center;">The report was signed with electronic signature.</p> <hr/> <p style="text-align: center;">/EXR224/Weighing_Data/2025-Jul-08/</p>	SAMPLE ID	WEIGHT	DATE	TIME	001	0.0000 g	2025-Jul-08	09:25:26	002	50.0024 g	2025-Jul-08	09:25:33	003	50.0015 g	2025-Jul-08	09:25:34	004	50.0013 g	2025-Jul-08	09:25:35	005	50.0011 g	2025-Jul-08	09:25:35	006	50.0010 g	2025-Jul-08	09:25:36	007	50.0011 g	2025-Jul-08	09:25:37
1	25.00120 g	23:19:39																																														
2	24.99835 g	23:19:46																																														
3	25.00070 g	23:19:47																																														
4	25.00087 g	23:19:48																																														
5	25.00106 g	23:19:49																																														
SAMPLE ID	WEIGHT	DATE	TIME																																													
001	0.0000 g	2025-Jul-08	09:25:26																																													
002	50.0024 g	2025-Jul-08	09:25:33																																													
003	50.0015 g	2025-Jul-08	09:25:34																																													
004	50.0013 g	2025-Jul-08	09:25:35																																													
005	50.0011 g	2025-Jul-08	09:25:35																																													
006	50.0010 g	2025-Jul-08	09:25:36																																													
007	50.0011 g	2025-Jul-08	09:25:37																																													

## 7 Library

Each Explorer EXR balance is equipped with an advanced library function that easy to create, edit, and activate libraries within seconds. The substantial memory capacity accommodates up to 11 weighing application modes and can store around 1000 library records.

In the Library menu, users can review the list of libraries they have generated for various application modes. These libraries can be exported to PC software and imported whenever necessary.

In the upper right corner, the total library memory is displayed. For instance, 9/1% indicates that 9 libraries have been created and are occupying approximately 1% of the total capacity. When the memory usage reaches 80%, the balance will display a message prompting the user to delete or back up library records.

Note:

The library name will change to Recipe according to different application modes.

HOME		LIBRARY			9 / 1%
LIBRARY ID	USER ID	APPLICATION	SAMPLE NAME	DATE AND TIME	
Library 009	Admin	Check Weighing		2025-Apr-29 13:39:19	
Library 008	Admin	Check Weighing		2025-Apr-29 13:39:18	
Library 007	Admin	Check Weighing		2025-Apr-29 13:39:16	
Library 006	Admin	Basic Weighing		2025-Apr-29 13:39:00	
Library 005	Admin	Basic Weighing		2025-Apr-29 13:38:59	

<      1 / 2      >

DELETE ALL	IMPORT	EXPORT ALL
------------	--------	------------

### 7.1 Library Data

The library can hold up to 1000 records in total. The following data is stored for the Application used:

Application Mode	Library Function	Data Specific to Application Modes	Sample Data
Basic Weighing	Yes	Minimum Weight	Sample Name Sample ID Batch ID Lot ID Project Name 10 x Customer ID
Parts Counting	Yes	APW, Sample Size	
Check Counting	Yes	APW, Sample Size, Over Limit, Under Limit	
Percent Weighing	Yes	Reference weight, Reference adjust	
Check Weighing	Yes	Over Limit, Under Limit, Nominal Weight, +Weight Tolerance, -Weight Tolerance, +Percent Tolerance, -Percent Tolerance	
Dynamic Weighing	Yes	Average Time	
Totalization	Yes		
Density Determination	Yes	Sinker Volume, Water Temp., Liquid Density, Oil Density	
Peak Hold	Yes		
Formulation	Recipe	Recipe Name, Item Name, Item Weight	
Differential Weighing	No Library		

\*Note: Up to 25 recipes can be stored in the Formulation/Recipe-based application.

## 7.2 Import and Export Library

Users can import a “library.db” file into the balance.

- Save the “library.db” file to a USB flash drive. Connect the USB drive to the balance. Once connected, the IMPORT button will become active.
- Press the IMPORT button to initiate the import process.

Users can export a “library.db” file to a USB flash device.

- Connect the USB flash drive to the balance. Once connected, the EXPORT button will become active.
- Press the EXPORT button to download the “library.db” file to the USB flash device.

Note:

- In the import process, the library will be renamed if import the same library name in the USB flash driver.

## 8 Maintenance

This function serves to is user to diagnostic hardware functions, update software, review the service log file, and provide service technicians to use service menu.

Notes:

- Service Menu is locked to prevent authority change make the incorrect weighing performance.
- If you encounter any issues while using the balance, please contact Ohaus or your local Ohaus dealer for assistance.

### 8.1 Maintenance Menu

User can diagnostic hardware functions, such as IR sensor, Digital Leveling Bubble, and Terminal Status Lights if connected.

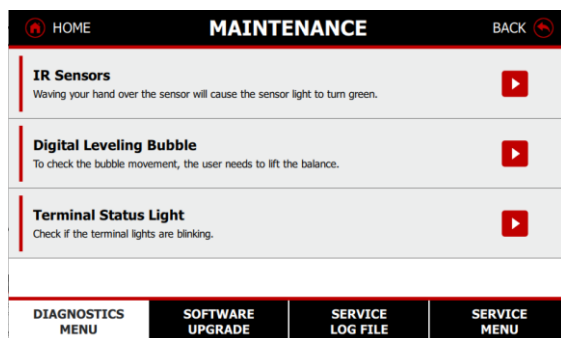

**IR Sensors:** Press **IR Sensors** to start testing. Waving your hand over it will trigger that function and cause the sensor light to turn green. When the function is working properly, the status icon on the right side will turn green.

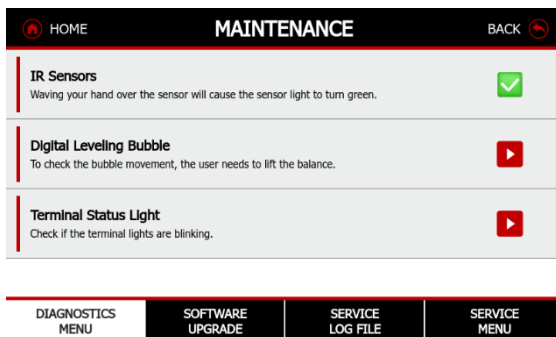

**Digital Leveling Bubble:** To check the bubble movement, the user needs to lift the balance. When the function is working properly, the status icon on the right side will turn green. If the leveling bubble is not moving, the status icon will display a warning sign.

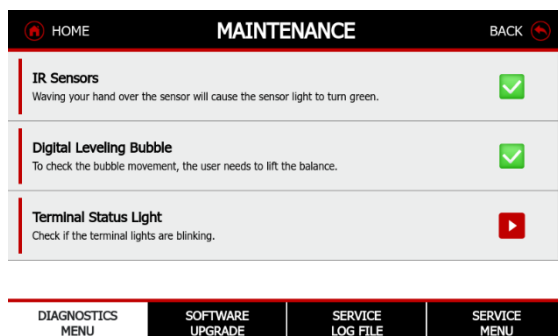

**Terminal Lights:** Press **Terminal Lights** button to check if the lights are functioning. The balance will cycle through all the light colors on the terminal.

## 8.2 Software Upgrade

In this function, users need to obtain the correct software to upgrade the balance for feature enhancements or bug fixes. If you encounter any issues while using the balance, please contact Ohaus or your local Ohaus dealer for assistance.

### 8.2.1 Software Upgrade Process

- Save the upgrade file into a USB flash drive.
- Connect the USB flash drive to the Balance.
- Press START button to upgrade the system.
- When completed, the balance will reboot automatically.

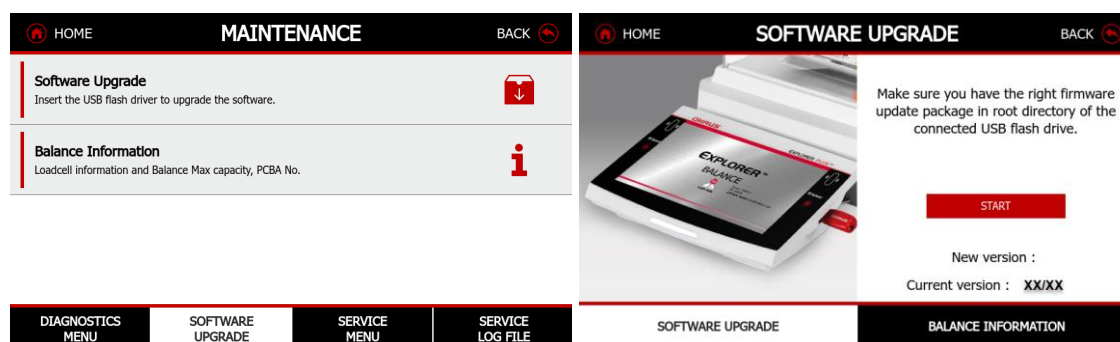

### 8.2.2 Balance Information

This screen would provide essential information of the balance.

## 8.3 Service Menu

Service Menu is locked to prevent authority change make the incorrect weighing performance. If you encounter any issues while using or service the balance, please contact Ohaus or your local Ohaus dealer for assistance.

## 8.4 Service Log File

The Service Log file is recording the balance Failure log, System Log, Calibration Log, Printed Data Log

- Failure Log: 100 of electronic record of record the number of times an overload /underload occurs.
- System Log: 100,000 entries which contain electronic records of the menu change on the balance, create/delete user, log in/off, date and time change and etc. Only Administrator and supervisor can be export to PDF as the un-editable format.
- Calibration Log:3000 electronic records of the user performed calibration reports and service performed calibration reports. Only Administrator and supervisor can be export to PDF as the un-editable format.
- Printed Data Log: 100,000 electronic records of the routine weighing data that is sent either by manually pressing the print key or through a command from a PC.

## 8.5 Factory Reset

Use this sub-menu to reset the menus to their Factory default settings.

- Reset All
- Quick Setup
- Calibration
- Balance Setup
- Application Modes
- Weighing Units
- Communication
- Library

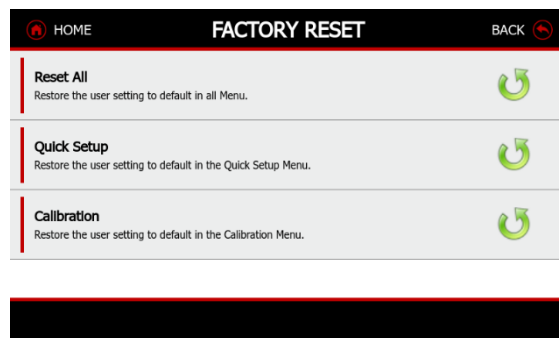

## 8.6 Log Off

Press this button to log out of the current user account.

## 8.7 Power Off

Press this button to turn off the balance.



## 9 Legal For Trade Application

When the balance is used in trade or a legally controlled application it must be set up, verified and sealed in accordance with local weights and measures regulations. It is the responsibility of the purchaser to ensure that all pertinent legal requirements are met.



\*For Explorer EXR ...N...models, please refer to Legal for Trade Settings.

### 9.1 Legal for Trade Setting

Before verification and sealing, perform the following steps in Order:

- Verify that the menu settings meet the local weights and measures regulations.
- Weighing Unit menu should be reviewed. Verify the units turned On meet the local weights and measures regulations.
- Perform a calibration as explained in 5.4 Calibration.
- Set the position of the Legal for Trade Switch to the locked position.

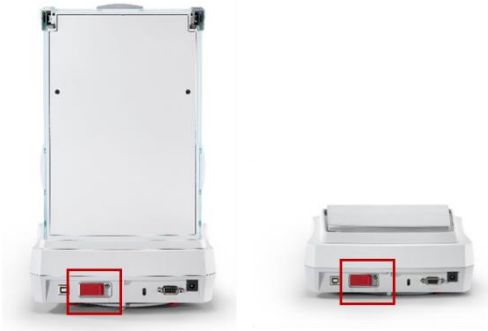
■ **Legal for Trade Switch:**

Explorer Analytical and Precision Balance	
Position	
Lock/ Unlock	

- Set Legal for Trade to ON in the Balance Setup menu refer to Approved Mode in section 5.5.11.

## 9.2 Balance Setting Changes

When Legal for Trade is set to ON, the menu settings are affected as follows:

Menu	Changes
Calibration Menu	<ul style="list-style-type: none"> <li>• Internal Calibration will be locked at On.</li> <li>For EXR...N... models: <ul style="list-style-type: none"> <li>○ If Internal Calibration is Off before turning on Approved Mode, the Internal Calibration field in Calibration Settings will be locked at Off.</li> <li>○ If Internal Calibration is On before turning on Approved Mode, the field and tab will remain unchanged.</li> </ul> </li> <li>• AutoCal™ will be locked at its current setting.</li> <li>• AutoCal™ Interval (Hours) will be locked at current setting.</li> <li>• Span Calibration will be locked at off and greyed out.</li> </ul>
Balance Setup Menu	<ul style="list-style-type: none"> <li>• Auto Zero Tracking is limited to 0.5d or Off.</li> <li>• If AZT is Off before turning on Approved Mode, then the field will be locked at "Off".</li> <li>• If AZT is on before turning on Approved Mode, the field will be forced to "0.5d" and locked.</li> <li>• Gross Indicator will be locked at the current setting.</li> <li>• Graduations will be forced to 1 Division and the field will be hidden.</li> <li>• For EXR...N...models, graduations will be locked at its current setting.</li> <li>• In System Log menu, Auto Login will be locked at Off.</li> </ul>
Maintenance Menu	<ul style="list-style-type: none"> <li>• Software Upgrade will be locked at Off.</li> <li>• Service Menu will be locked at Off.</li> </ul>
Weighing Units Menu	<ul style="list-style-type: none"> <li>• Units will be restricted to metric units.</li> <li>• For EXR...N...models, Units will be restricted to metric and imperial units.</li> </ul>
Printing Settings Menu	<ul style="list-style-type: none"> <li>• In Connect to Printer, Numeric Only will be locked at off, and Manual Print will be locked at Stable only.</li> <li>• In Connect to PC, Numeric Only will be locked at off, and Manual Print will be locked at Stable only.</li> <li>• In Data to Excel, Manual Print will be locked at Stable only</li> </ul>
Terminal Setting:	<ul style="list-style-type: none"> <li>• After turning on Approved Mode, it will not be allowed to switch terminal.</li> </ul>
Applications	<ul style="list-style-type: none"> <li>• In Item Settings menu, Auto Tare will be locked at Off.</li> </ul>

## 9.3 Verification

The calibration weights and measures official or authorized service agent must perform the verification procedure.

## 9.4 Sealing

After the Balance has been verified, it must be sealed to prevent undetected access to the legally controlled settings. Before sealing the device, ensure that the security switch is in the Locked position and the Legal for Trade setting in the Balance Setup menu has been set to ON.

If using a wire seal, pass the sealing wire through the holes in the security switch and Bottom Housing as shown.

If using a paper seal, place the seal over the security switch and Bottom Housing as shown.

- Semi-Micro, Analytical and Precision Balance



## 9.5 Output Format

### Strings Definition

Field:	Label <sup>1</sup>	Space <sup>2</sup>	Weight <sup>3</sup>	Space <sup>2</sup>	Unit <sup>4</sup>	Space	Stability <sup>5</sup>	Space	G/N <sub>6</sub>	Space	Term. Characters <sup>7</sup>
Length:		1	11	1		1	≤ 1	≤ 1	≤ 3	0	≤ 8

- In certain cases, a Label field of up to 11 characters is included.
- Each field is followed by a single delimiting space (ASCII 32).
- The Weight field is 9 right justified characters. If the value is negative, the “-” character is located at the immediate left of the most significant digit.
- The Unit field contains the unit of measure abbreviation up to 5 characters.
- The Stability field contains the “?” character if the weight reading is not stable. The Stability field and the following Space field are omitted if the weight reading is stable.
- The G/N field contains the net or gross indication. For net weights, the field contains “NET”. For gross weights, the field contains nothing, “G” or “B”, depending on the GROSS INDICATOR menu setting.
- The Termination Characters field contains CRLF, Four CRLF or Form Feed (ASCII 12), depending on the LINE FEED menu setting.

## 10 MAINTENANCE

### 10.1 Calibration

Periodically verify calibration by placing an accurate weight on the balance and viewing the result. If calibration is required, perform a Balance internal calibration.

### 10.2 Cleaning



**WARNING:** Electric Shock Hazard. Disconnect the equipment from the power supply before cleaning. Make sure that no liquid enters the interior of the instrument.



**Attention:** Do not use solvents, harsh chemicals, ammonia or abrasive cleaning agents.

The housing may be cleaned with a cloth dampened with a mild detergent if necessary.

### 10.3 Troubleshooting

Symptom / Display	Possible Cause	Remedy
Balance will not turn on	<ul style="list-style-type: none"> <li>No power supply to the Balance</li> </ul>	<ul style="list-style-type: none"> <li>Verify connection and voltage</li> </ul>
Inaccuracy weighing results	<ul style="list-style-type: none"> <li>Improper calibration</li> <li>Unstable environment</li> </ul>	<ul style="list-style-type: none"> <li>Perform calibration</li> <li>Move balance to suitable location</li> </ul>
Cannot calibrate	<ul style="list-style-type: none"> <li>Calibration Menu locked</li> <li>Approved Mode set to on</li> <li>Instable environment</li> <li>Incorrect calibration masses</li> </ul>	<ul style="list-style-type: none"> <li>Turn Calibration menu lock off</li> <li>Turn Approved Mode off</li> <li>Move balance to suitable location</li> <li>Use correct calibration masses</li> </ul>
Cannot change menu settings	<ul style="list-style-type: none"> <li>Sub-menu locked</li> <li>Approved Mode set to on</li> </ul>	<ul style="list-style-type: none"> <li>Unlock sub-menu</li> <li>Turn Approved Mode off</li> </ul>
Low Reference Weight	<ul style="list-style-type: none"> <li>Reference weight too small</li> <li>The weight on the pan is too small to define a valid reference weight.</li> </ul>	<ul style="list-style-type: none"> <li>Increase sample size</li> </ul>
Invalid Piece Weight	<ul style="list-style-type: none"> <li>Average piece weight is too small</li> </ul>	<ul style="list-style-type: none"> <li>Increase average piece weight</li> </ul>
Operation Timeout	<ul style="list-style-type: none"> <li>Weight reading is not stable</li> </ul>	<ul style="list-style-type: none"> <li>Move balance to suitable location</li> </ul>
-----	<ul style="list-style-type: none"> <li>Busy (tare, zero, printing)</li> </ul>	<ul style="list-style-type: none"> <li>Wait until completion</li> </ul>

### 10.4 End of Life Instruction

OHAUS electronic balances are precision instruments consisting of a metal housing, coated aluminum weighing cells, stainless steel parts, ABS/PC plastic parts, cardboard and foam packaging, and other materials. Kindly comply with the sustainable instructions for handling the balance when it is not in use or reaches the end of its operational lifespan.

**Data Management:** Before disposing of the electronic balance, ensure that all sensitive data or user information is erased from the device. Follow the balance instruction manual for data removal or seek OHAUS service engineer provider assistance.

**Reuse or Donate:** Consider donating your electronic balance to a school, community center, or charitable organization that might have a use for it. Reusing the equipment is the most sustainable option.

**Recycling:** If the electronic balance is no longer functional or cannot be reused, consider recycling it. Look for electronic recycling centers in your area that accept electronic equipment. Make sure to choose a reputable recycling center that follows proper e-waste disposal regulations. In both the US and the EU, aluminum and

stainless steel are considered readily recyclable while ABS/PC plastic can be recycled, but not as easily. In the UK, aluminum, stainless steel, and ABS/PC plastics are considered readily recyclable.

**Disposal:** If recycling is not an option, dispose of the electronic balance responsibly. Do not throw it in the regular trash, as it can potentially harm the environment. Check with your local waste management authorities for guidance on properly disposing of electronic equipment, such as EU directive 2002/96/EC (WEEE), refer to

**Packaging:** When transporting the electronic balance for recycling or disposal, use minimal packaging material and consider using eco-friendly packaging options. Avoid single-use plastics and opt for recyclable or biodegradable materials.

**Sustainable Alternatives:** When purchasing a new electronic balance, choose a product from a manufacturer that prioritizes sustainability.

### 10.4.1 Material Composition of 1mg, 0.1mg and 0.01mg Draftshield Models

- Material Composition for Explorer EXR Draftshield Models

#	Material Composition	Main Usage	Recycled Materials Ratio	Weight (kilograms)	Ratio to Total Weight (%)
<b>Products</b>	Metal Parts	Housing, Loadcell	100% Aluminum	4.04	40%
	Plastic Parts	Leveling feet, Wing Rings, In-use-cover	50% ABS	1.04	10%
	Glass	Draftshield Doors	N/A	1.58	16%
	Electronic Parts	PCB		0.54	5%
	Fastener	Screws	70% SST	0.08	1%
	Cables	Connections	Copper and Rubber skin	0.11	1%
<b>Packaging</b>	Paper Parts	Carton Box	100% recycle	1.88	18%
	Foams	Shipping Foams	100% EPP	0.92	9%
<b>Total Weights</b>				10.2	100%

## 10.5 Service Information

OHAUS prioritizes energy-efficient design, eco-friendly packaging, and other sustainable objectives, reflected in all its laboratory weighing products that incorporate sustainable product goals. By following these sustainable end-of-life instructions, you can ensure that your electronic balance is disposed of in an environmentally friendly and sustainable manner. Thank you for choosing the OHAUS instrument and taking the necessary steps to protect the environment.

If the troubleshooting section does not resolve your problem, contact an Authorized Ohaus Service Agent. Please visit our website to locate the Ohaus office nearest you. An Ohaus Product Service Specialist will be available to assist you.

# 11 TECHNICAL DATA

## 11.1 Specifications

### Ambient Conditions

- Indoor use only
- Altitude: 2000 m
- Specified Temperature range: 10°C to 30°C. Operability is assured at ambient temperatures between 5°C and 40°C. For EXR...4N.. NTEP models the temperature range should be 15°C to 25°C.
- Humidity: Maximum relative humidity 80% for temperatures up to 31 °C decreasing linearly to 50% relative humidity at 40°C.
- Electrical supply:
  - 12VDC, 1.5A. (For use with certified or approved power supply, which must have a SELV and limited energy output.) (For the models powered by external power adapter.)
- Mains supply voltage fluctuations: up to ±10% of the nominal voltage
- Installation category II
- Pollution degree: 2

### Materials

- Bottom Housing;
  - Die-cast Aluminum, Painted
- Top Housing: Die-cast Aluminum, Painted
- Terminal: Glass, Die-cast Aluminum
- Weighing Platforms:
  - Plastic (PC)
- Weighing Pan:
  - Zink alloy (0.01mg models)
  - 316 SST (0.1mg, 1mg, 0.01g, 0.1g models)
- In-use Cover: plastic (PET)
- Draft Shield; Glass, Aluminum, Plastic

## 11.2 Model Specification Tables

MODEL	EXR125D	EXR125	EXR225D	EXR225
	EXR125DM	EXR125M	EXR225DM	EXR225M
Capacity (g)	82 g / 120 g	120 g	120 g / 220 g	220 g
Readability d, fine range (g)	0.01 mg	0.01 mg	0.01 mg	0.01 mg
Readability d, full range (g)	0.1 mg	0.01 mg	0.1 mg	0.01 mg
Repeatability (sd.), ≤5% of full load	0.01 mg	0.01 mg	0.01 mg	0.01 mg
Repeatability (sd.), 5% of full load to fine range max	0.02 mg	0.02 mg	0.02 mg	0.02 mg
Repeatability (sd.), fine range max to full range	0.1 mg	0.02 mg	0.1 mg	0.02 mg
Linearity deviation typical	0.06 mg	0.06 mg	0.06 mg	0.06 mg
Linearity deviation	0.2 mg	0.1 mg	0.2 mg	0.1 mg
Verification interval, e (EXR...M.models only)	1 mg	1 mg	1 mg	1 mg
Approval Class (EXR...M.. models only)	Class I	Class I	Class I	Class I
Span Calibration Points	25g, 50g, 75g, <b>100g</b>	25g, 50g, 75g, <b>100g</b>	50g, 100g, 150g, <b>200g</b>	50g, 100g, 150g, <b>200g</b>
Weighing units	<b>15 weighing units:</b> g, mg, ct, N, oz, ozt, Grain, dwt, mo, msg, tcl, tola, baht, Custom 1, Custom 2			
Weighing units for EXR...M..Models*	g, mg, ct			
Applications	<b>11 application modes:</b> Basic Weighing, Parts Counting, Check Counting, Percent Weighing, Check Weighing, Dynamic Weighing, Totalization, Formulation, Differential, Density Determination, and Peak Hold			
Stabilization time (typical)	0.1 mg: ≤2 seconds; 0.01 mg: ≤ 5 seconds			
Sensitivity Temperature Drift (ppm/K)	0.8			
Min-Weight (typical) (USP, K=2, U=0.10%)	20 mg			
Min-Weight (optimal) (USP, K=2, U=0.10%, SRP≤0.41d)	8.2 mg			
Terminal Display	7-inch TFT 16.7M Color Press Screen with Glass Overlay			
Number of Dots	800 x 480 DOTS			
Communication	USB Host (Type A) x 2 USB Device (Type C) x 1 Ethernet (RJ45) x 1 RS232 x 1 Optional Wi-Fi/ Bluetooth Dongle			
Leveling System	Digital Leveling Bubble			
Power Supply	AC Adapter Output: 12 VDC 1.5A			
Weighing Pan Size	Aero Pan 80 x 80 mm			
IR Sensor	2 Touchless Sensors on the terminal			
Draftshield with anti-static coating	Standard			
Terminal Status Lights	Standard			
Assembled Dimensions (W x D x H)	230 mm x 393 mm x 370 mm			
Shipping Dimensions (W x D x H)	415 mm x 630 mm x 561 mm			
Net Weight	7.4 kg			
Shipping Weight	10.2 kg			

MODEL	EXR124	EXR224	EXR324
	EXR124M	EXR224M	EXR324M
	EXR124N	EXR224N	EXR324N
Capacity (g)	120 g	220 g	320 g
Readability d, full range (mg)	0.1 mg	0.1 mg	0.1 mg
Readability d (EXR...N...model)	0.1 mg (EXR...N...model: 0.1mg or 1mg)		
Repeatability (sd.), ≤5% of full load	0.05 mg	0.05 mg	0.05 mg
Repeatability (sd.), 5% of full load to fine range max	0.1 mg	0.1 mg	0.1 mg
Linearity deviation typical	0.06 mg	0.06 mg	0.06 mg
Linearity deviation	0.2 mg	0.2 mg	0.2mg
Verification interval, e (EXR...M..models only)	1 mg	1 mg	1 mg
Approval Class (EXR...M.. models only)	Class I	Class I	Class I
Span Calibration Points (g)	25g, 50g, 75g, <b>100g</b>	50g, 100g, 150g, <b>200g</b>	100g, 150g, 200g, <b>300g</b>
Weighing units	<b>18 weighing units:</b> g, mg, ct, N, oz, ozt, Grain, dwt, mo, msg, tl H, tl S, tl T, tcl, tola, baht, Custom 1, Custom 2		
Weighing units for EXR...M.. and EXR N...Models*	<b>EXR...M.. models:</b> g, mg, ct <b>EXR...N models:</b> g, mg, ct, oz, ozt, Grain, dwt		
Applications	<b>11 application modes:</b> Basic Weighing, Parts Counting, Check Counting, Percent Weighing, Check Weighing, Dynamic Weighing, Totalization, Formulation, Differential, Density Determination, and Peak Hold		
Stabilization time (typical)	2 seconds		
Sensitivity Temperature Drift (ppm/K)	1.5	1.5	1.5
Min-Weight (typical) (USP, K=2, U=0.10%)	100 mg		
Min-Weight (optimal) (USP, K=2, U=0.10%, SRP≤0.41d)	82 mg		
Terminal Display	7-inch TFT 16.7M Color Press Screen with Glass Overlay		
Number of Dots	800 x 480 DOTS		
Communication	USB Host (Type A) x 2 USB Device (Type C) x 1 Ethernet (RJ45) x 1 RS232 x 1 Optional Wi-Fi/ Bluetooth Dongle		
Leveling System	Digital Leveling Bubble		
Power Input	12 VDC, 1.5A		
Power Supply	AC Adapter Input: 100-240 VAC 0.5A 50-60 Hz AC Adapter Output: 12 VDC 1.5A		
Weighing Pan Size	Square Pan 90 x 90 mm		
IR Sensor	2 Touchless Sensors on the terminal		
Draftshield with anti-static coating	Standard		
Terminal Status Lights	Standard		
Assembled Dimensions (W x D x H)	230 mm x 393 mm x 370 mm		
Shipping Dimensions (W x D x H)	415 mm x 630 mm x 561 mm		
Net Weight	7.4 kg		
Shipping Weight	10.2 kg		



MODEL	EXR223	EXR423	EXR623	EXR1203
	EXR223M	EXR423M	EXR623M	EXR1203M
	EXR223N	EXR423N	EXR623N	EXR1203N
Capacity (g)	220 g	420 g	620 g	1200 g
Readability d (mg)	1mg	1mg	1mg	1mg
Readability d (EXR...N...model)	1 mg (EXR...N...model: 1mg or 10mg)			
Repeatability (sd.), ≤5% of full load (mg)	0.7 mg	0.7 mg	0.7 mg	0.7 mg
Repeatability (sd.), 5% of full load to fine range max (mg)	1 mg	1 mg	1 mg	1 mg
Linearity Deviation typical	0.6 mg	0.6 mg	0.6 mg	0.6 mg
Linearity Deviation	2 mg	2 mg	2 mg	2 mg
Verification interval, e (EXR...M models and EXR...N models only)	10 mg	10 mg	10 mg	10 mg
Approval Class (EXR...M.. models and EXR..N..models only)	Class II	Class II	Class II	Class I
Span Calibration Points	50g, 100g, 150g, <b>200g</b>	100g, 200g, 300g, <b>400g</b>	300g, 400g, 500g, <b>600g</b>	400g, 600g, 800g, <b>1000g</b>
Weighing units	<b>20 weighing units:</b> g, mg, ct, N, oz, ozt, Grain, dwt, mo, msg, tl H, tl S, tl T, tcl, tola, baht, Custom 1, Custom 2, lb (models with capacity ≥ 620 g), kg (models with capacity ≥ 1200 g)			
Weighing units for EXR...M.. and EXR...N...Models*	<b>EXR...M.. models:</b> g, mg, ct, kg (models with capacity ≥ 1200 g) <b>EXR...N.. models:</b> g, mg, ct, oz, ozt, Grain, dwt, lb (models with capacity ≥ 620 g), kg (models with capacity ≥ 1200 g)			
Applications	<b>11 application modes:</b> Basic Weighing, Parts Counting, Check Counting, Percent Weighing, Check Weighing, Dynamic Weighing, Totalization, Formulation, Differential, Density Determination, and Peak Hold			
Stabilization time (typical)	≤ 1.5 seconds			
Sensitivity Temperature Drift (ppm/K)	3			
Min-Weight (typical) (USP, K=2, U=0.10%)	1.4 g			
Min-Weight (optimal) (USP, K=2, U=0.10%, SRP≤0.41d)	0.82 g			
Terminal Display	7-inch TFT 16.7M Color Press Screen with Glass Overlay			
Number of Dots	800 x 480 DOTS			
Communication	USB Host (Type A) x 2 USB Device (Type C) x 1 Ethernet (RJ45) x 1 RS232 x 1 Optional Wi-Fi/ Bluetooth Dongle			
Leveling System	Digital Leveling Bubble			
Power Input	12 VDC, 1.5A			
Power Supply	AC Adapter Input: 100-240 VAC 0.5A 50-60 Hz AC Adapter Output: 12 VDC 1.5A			
Weighing Pan Size	Square Pan 130 x 130 mm			
IR Sensor	2 Touchless Sensors on the terminal			
Draftshield with anti-static coating	Standard			
Terminal Status Lights	Standard			
Assembled Dimensions (W x D x H)	230 mm x 393 mm x 370 mm			
Shipping Dimensions (W x D x H)	415 mm x 630 mm x 561mm			
Net Weight	7.4 kg			
Shipping Weight	10.2 kg			

MODEL	EXR2202	EXR4202	EXR6202	EXR8202	EXR12202
	EXR2202M	EXR4202M	EXR6202M	EXR8202M	EXR12202M
	EXR2202N	EXR4202N	EXR6202N	EXR8202N	EXR12202N
Capacity (g)	2200 g	4200 g	6200 g	8200 g	12200 g
Readability d, full range (g)	0.01 g	0.01 g	0.01 g	0.01 g	0.01 g
Readability d (EXR...N...model)	0.01 g (EXR...N...model: 0.01 g or 0.1 g)				
Repeatability (sd.), ≤5% of full load (g)	0.007 g	0.007 g	0.007 g	0.007 g	0.007 g
Repeatability (sd.), 5% of full load to fine range max (g)	0.01 g	0.01 g	0.01 g	0.01 g	0.01 g
Linearity Deviation Typical	0.006 g	0.006 g	0.006 g	0.006 g	0.006 g
Linearity Deviation	0.02 g	0.02 g	0.02 g	0.02 g	0.02 g
Verification interval, e (EXR...M.. models and EXR...N..models only)	0.1 g	0.1 g	0.1 g	0.1 g	0.1 g
Approval Class (EXR...M.. models and EXR...N..models only)	Class II	Class II	Class II	Class II	Class I
Span Calibration Points	500g, 1000g, 1500g, <b>2000g</b>	1000g, 2000g, 3000g, <b>4000g</b>	2000g, 3000g, 4000g, 5000g, <b>6000g</b>	2000g, 4000g, 6000g, <b>8000g</b>	6000g, 8000g, 10000g, <b>12000g</b>
Weighing units	<b>19 weighing units:</b> g, ct, N, oz, ozt, Grain, dwt, mo, msg, tl H, tl S, tl T, tcl, tola, baht, lb, kg Custom 1, Custom 2				
Weighing units for EXR...M. and EXR...N...Models*	<b>EXR...M.. models:</b> g, ct, kg <b>EXR...N.. models:</b> g, ct, oz, ozt, Grain, dwt, lb, kg				
Applications	<b>11 application modes:</b> Basic Weighing, Parts Counting, Check Counting, Percent Weighing, Check Weighing, Dynamic Weighing, Totalization, Formulation, Differential, Density Determination, and Peak Hold				
Stabilization time (typical)	≤ 1 second				
Sensitivity Temperature Drift (ppm/K)	3				
Min-Weight (typical) (USP, K=2, U=0.10%)	14 g				
Min-Weight (optimal) (USP, K=2, U=0.10%, SRP≤0.41d)	8.2 g				
Terminal Display	7-inch TFT 16.7M Color Press Screen with Glass Overlay				
Number of Dots	800 x 480 DOTS				
Communication	USB Host (Type A) x 2 USB Device (Type C) x 1 Ethernet (RJ45) x 1 RS232 x 1 Optional Wi-Fi/ Bluetooth Dongle				
Leveling System	Digital Leveling Bubble				
Power Input	12 VDC, 1.5A				
Power Supply	AC Adapter Input: 100-240 VAC 0.5A 50-60 Hz AC Adapter Output: 12 VDC 1.5A				
Weighing Pan Size	Trapezoid Pan 178 x 201 mm				
IR Sensor	2 Touchless Sensors on the terminal				
Terminal Status Lights	Standard				
Assembled Dimensions (W x D x H)	229 mm x 391 mm x 95 mm				
Shipping Dimensions (W x D x H)	385 mm x 590 mm x 311mm				
Net Weight	4.9 kg				
Shipping Weight	7.1 kg				

MODEL	EXR6201	EXR8201	EXR10201
	EXR6201M*	EXR8201M*	EXR10201M*
Capacity (g)	6200 g	8200 g	10200 g
Readability d, full range (g)	0.1 g	0.1 g	0.1 g
Repeatability (sd.), ≤5% of full load	0.07 g	0.07 g	0.07 g
Repeatability (sd.), 5% of full load to fine range max	0.1 g	0.1 g	0.1 g
Linearity Deviation Typical	0.06 g	0.06 g	0.06 g
Linearity Deviation	0.2 g	0.2 g	0.2 g
Verification interval, e (EXR...M..models only)	0.1 g	0.1 g	0.1 g
Approval Class (EXR...M.. models only)	Class II	Class II	Class I
Span Calibration Points (g)	2000g, 3000g, 4000g, <b>6000g</b>	2000g, 4000g, 6000g, <b>8000g</b>	2500g, 5000g, 7500g, <b>10000g</b>
Weighing units	<b>19 weighing units:</b> g, ct, N, oz, ozt, Grain, dwt, mo, msg, tl H, tl S, tl T, tcl, tola, baht, lb, kg, Custom 1, Custom 2		
Weighing units for EXR...M.. Models*	<b>EXR...M.. models:</b> g, ct, kg		
Applications	<b>11 application modes:</b> Basic Weighing, Parts Counting, Check Counting, Percent Weighing, Check Weighing, Dynamic Weighing, Totalization, Formulation, Differential, Density Determination, and Peak Hold		
Stabilization time (typical)	≤ 1 second		
Sensitivity Temperature Drift ( ppm/K)	5	3	3
Min-Weight (typical) (USP, K=2, U=0.10%)	140 g		
Min-Weight (optimal) (USP, K=2, U=0.10%, SRP≤0.41d)	82 g		
Terminal Display	7-inch TFT 16.7M Color Press Screen with Glass Overlay		
Number of Dots	800 x 480 DOTS		
Communication	USB Host (Type A) x 2 USB Device (Type C) x 1 Ethernet (RJ45) x 1 RS232 x 1 Optional Wi-Fi/ Bluetooth Dongle		
Leveling System	Digital Leveling Bubble		
Power Input	12 VDC, 1.5A		
Power Supply	AC Adapter Input: 100-240 VAC 0.5A 50-60 Hz AC Adapter Output: 12 VDC 1.5A		
Weighing Pan Size	Trapezoid Pan 178 x 201 mm		
IR Sensor	2 Touchless Sensors on the terminal		
Terminal Status Lights	Standard		
Assembled Dimensions (W x D x H)	230 mm x 393 mm x 96 mm		
Shipping Dimensions (W x D x H)	385 mm x 590 mm x 311mm		
Net Weight	4.9 kg		
Shipping Weight	7.1 kg		

**Note 1:** M = EC Type approved

N = NTEP certified and Measurement Canada approved

C1= Custom Unit 1; C2= Custom Unit 2

**Note 2:** Default Calibration weights shown in Bold

**Note 3:** \* Availability is dependent on region.

### 11.3 Accessory Specifications

#### The LM842 USB Adapter (Dongle)

##### TECH SPEC



WIRELESS STANDARD	802.11ac
BACKWARD COMPATIBILITY	802.11a, 802.11b, 802.11g, 802.11n
FREQUENCY	2.4 GHz and 5 GHz
ADAPTER TYPE	Host Controller Interface (HCI)
INTERFACES	USB
ANTENNA	2 x Metal Frame Antennas, SMA Connector
ANTENNA OPTION	1 x Metal Frame Antenna + 1 x SMA Connector
COMPATIBLE ANTENNAS	LM256 2dBi, LM255 1.5dBi, LM251 2dBi
DIMENSIONS	32-37mm x 17.1mm x 94mm
OPERATING TEMPERATURE	-20°C to +85°C
BLUETOOTH TECHNOLOGY	Bluetooth Classic, Bluetooth Low Energy (LE)
COMPATIBILITY	Android, Linux, Win 10, Win 7
CERTIFICATIONS	
COMPLIANCE	

### 11.4 Drawings and Dimensions

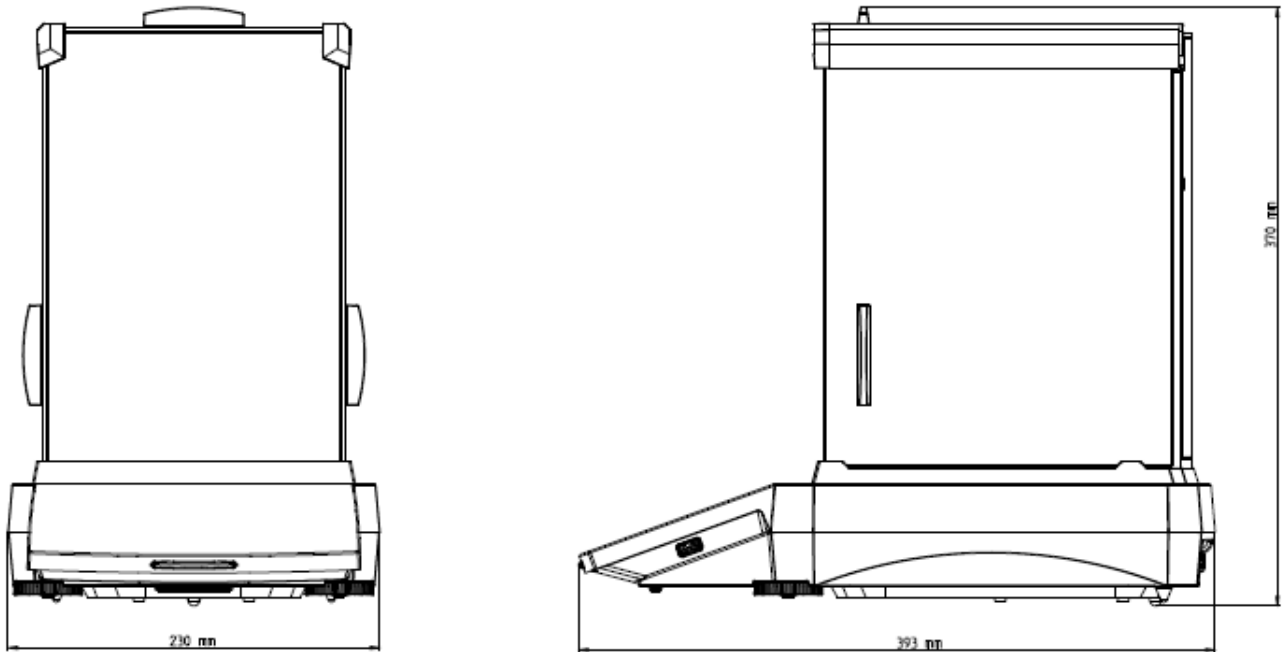

Figure 9-1. Draft Shield models

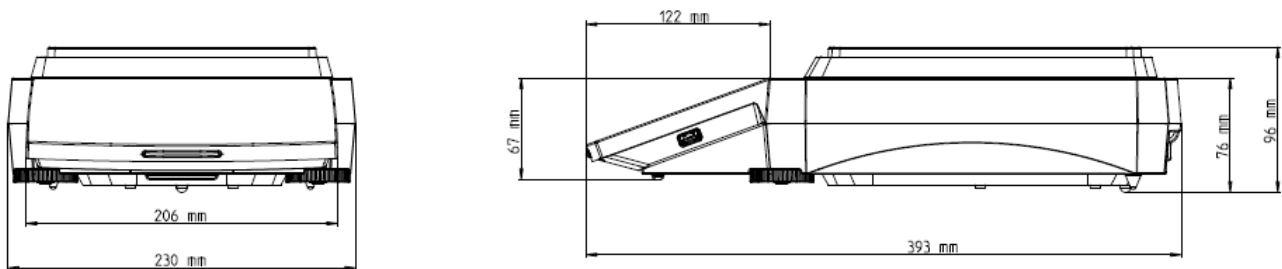



Figure 9-2. Non-Draft Shield models

### 11.5 Accessories

Image	Description
	<p><b>Item Number</b>                      30095929 (EU)                      30130303 (AP)                      30130302 (US)</p> <p><b>Accessory Name</b>                      Static Ionizer, ION-100A</p>
	<p><b>Item Number</b>                      80253384</p>

	<p><b>Accessory Name</b> Density Kit, Solids</p>
	<p><b>Item Number</b> 83034024</p> <p><b>Accessory Name</b> Sinkers, Glass, Liquid, Density Kit</p>
	<p><b>Item Number</b> 31059237</p> <p><b>Accessory Name</b> Weighing Kit</p>
	<p><b>Item Number</b> 31059239</p> <p><b>Accessory Name</b> BT dongle and Wi-Fi dongle LM842</p>
	<p><b>Item Number</b> 30064202 (EU) 30045641 (AP) 30064203 (US)</p> <p><b>Accessory Name</b> Printer, Impact, SF40A</p>
	<p><b>Item Number</b> 30960983 (EU) 30960982 (AP) 30960984 (US)</p> <p><b>Accessory Name</b> Bluetooth Printer, Impact, SF40A/BT</p>

	<b>Item Number</b> 12120799
	<b>Accessory Name</b> SF40A Paper roll (57,5mm 2pcs)
	<b>Item Number</b> 30529322
	<b>Accessory Name</b> SF40A Ink Ribbon Cassette

## 11.6 Interface Commands

Commands listed in the following table will be acknowledged by the balance.

- Commands sent to the indicator must be terminated by a carriage return-line feed (CRLF).
- Data output is always terminated with a carriage return-line feed (CRLF).
- The balance will return “ES” for invalid commands.

Command	Function
AUF	Auto login (Only work when User Management function is off)
I2	Inquiry of balance data
I3	Inquiry of balance SW version and type definition number
I4	Inquiry of serial number
SIR	Send weight value immediately and repeat
IP	Immediate Print of displayed weight (stable or unstable). IP could be used to stop continuous print and interval print.
P	Print displayed weight according to “ Stable only ” setting in the communication menu. Attention: when APPROVED MODE IS ON, P could only print stable displayed weight.
CP	Continuous Print.
SP_x	Print on Stability. (x: stable time, print if stability is achieved within this time)
P_x	Interval Print x = Print Interval (1-3600 sec) IP/P ends interval Print. Attention: the corresponding settings in the communication menu are modified too.
Z	Same as pressing Zero Key
ZI	Zero Immediately

Command	Function
@	Reboot
T	Same as pressing Tare Key.
TI	Tare Immediately
M_x	Set current application mode to x. x depends on application, use application list.
U_x	Set balance to unit x: g, Kg, lb, oz, etc. . x depends on unit list.
ON	Brings out of Standby
OFF	Goes to Standby.
SIU	Send weight value with currently displayed unit immediately
C3	Begin internal Calibration, same as trigger from calibration menu.
PSN	Print Serial Number.
PV	Print terminal software version, base software version and Approved Mode is set to ON.
#_x _Unit	Set Counting APW (x) in Unit. (must have APW stored, unit can be any unit, g, lb, etc)
%_x _Unit	Set Percent application reference weight (x) in Unit. (must have reference weight stored, unit can be any unit, g, lb, etc)
CO_x _Unit	Set Check weighing Over Limit in x Unit.
CU_x _Unit	Set Check weighing Under Limit in x Unit.
TIM	Print current time.
DAT	Print current date.
TIM_x	Set Time, x format: hh mm ss.
DAT_x	Set Date, x format: mm dd yyyy.
\EscP	Print weight immediately
\EscT	Tare
\EscU	Tare
\EscV	Zero
\EscW	External calibration
\EscZ	Internal calibration
\Escx1_#_	Print model
\Escx3_#_	Print software version



**Note:**

There is 40-second timeout control for print under stable requirement. If the unstable condition continues over 40 seconds, balance will back to previous display.

**Application list:**





<b>ID</b>	<b>application name</b>	<b>Abbreviation</b>
0	Basic weighing	Weighing
1	Parts Counting	Counting
2	Percent weighing	Percent
3	Check weighing	Check
4	Dynamic weighing	Dynamic
6	Totalization	Totalization
7	Formulation	Formulation
8	Differential	Differential
9	Density Determination	Density
10	Peak hold	Peak
19	Check Counting	

## Unit list:

ID	Unit name	Abbreviation
0	Gram	g
1	Kilogram	kg
2	Ton	t
3	Milligram	mg
4	Microgram	ug
5	Carat	ct
6	New ton	N
7	Pound	lb
8	Ounce	oz
9	Ounce (troy)	ozt
10	Grain	GN
11	Penny	dwt
12	Momme	mom
13	Mesghal	msg
14	Tael Hongkong	HKt
15	Tael Singapore	SGt
16	Tael Taiwan	TWt
17	Tical	tcl
18	Tola	tola
19	Baht	baht
20	Pound:Ounces (for U.S. postal / industrial / retail applications)	lb:oz
21	Custom unit 1	C1
22	Custom unit 2	C2

## 12 COMPLIANCE

Compliance to the following standards is indicated by the corresponding mark on the product.

Mark	Standard
	This product complies with the applicable harmonized standards of EU Directives 2011/65/EU (RoHS), 2014/30/EU (EMC), 2014/35/EU (LVD) and 2014/31/EU (NAWI). The EU Declaration of Conformity is available.
	This product complies with the EU Directive 2012/19/EU (WEEE). Please dispose of this product in accordance with local regulations at the collecting point specified for electrical and electronic equipment.
	EN 61326-1
	CAN/CSA-C22.2 No. 61010-1 UL 61010-1
LM842 USB Dongle	Compliant to: IEEE 802.11ac, abgn additional standards, Compliant to: Bluetooth® 5.02 and backward compatible with Bluetooth v2.1+EDR / v3.0 / v3.0+HS / v4.0, 4.1, & 4.2 with both BR/EDR. Classic and LE can operate simultaneously. The Realtek IC, RTL8822CU uses a USB main interface. LM842 offers high throughput for both WiFi and Bluetooth® connections, connected via a (HCI) USB 2.0 TYPE A interface The LM842 is certified for United States of America, under FCC and Europe under CE standards.

### Important notice for Explorer EXR...M verified weighing instruments in the EU.

When the instrument is used in trade or a legally controlled application it must be set up, verified and sealed in accordance with local weights and measures regulations. It is the responsibility of the purchaser to ensure that all pertinent legal requirements are met.

Weighing Instruments verified at the place of manufacture must bear one of the following supplementary metrologies marking on the descriptive plate.



Weighing Instruments to be verified in two stages have no supplementary metrology marking on the descriptive plate. The second stage of conformity assessment must be carried out by the applicable weights and measures authorities.

If national regulations limit the validity period of the verification, the user of the weighing instrument must strictly observe the re-verification period and inform the weights and measures authorities.

As verification requirements vary by jurisdiction, the purchaser should contact their local weights and measures office if they are not familiar with the requirements.

### Industry Canada Note

CAN ICES-003(A) / NMB-003(A)

**ISO 9001 Registration**

The management system governing the production of this product is ISO 9001 certified.

Notes:

All the icons used for terminal design are sourced from a free platform: \_\_\_\_\_

Note: All the sound used for volume design are sourced from a free platform: (

**FCC Supplier Declaration of Conformity**

Unintentional Radiator per 47CFR Part B

Trade Name: OHAUS CORPORATION

Model: Explorer™ EXR...

**FCC Compliance Statement:**

Note: This equipment has been tested and found to comply with the limits for a Class A digital device, pursuant to part 15 of the FCC Rules. These limits are designed to provide reasonable protection against harmful interference when the equipment is operated in a commercial environment. This equipment generates, uses, and can radiate radio frequency energy and, if not installed and used in accordance with the instruction manual, may cause harmful interference to radio communications. Operation of this equipment in a residential area is likely to cause harmful interference in which case the user will be required to correct the interference at his own expense. Changes or modifications not expressly approved by the party responsible for compliance could void the user's authority to operate the equipment.

## 13 LIMITED WARRANTY

Ohaus products are warranted against defects in materials and workmanship from the date of delivery through the duration of the warranty period. During the warranty period Ohaus will repair, or, at its option, replace any component(s) that proves to be defective at no charge, provided that the product is returned, freight prepaid, to Ohaus.

This warranty does not apply if the product has been damaged by accident or misuse, exposed to radioactive or corrosive materials, has foreign material penetrating to the inside of the product, or because of service or modification by other than Ohaus. In lieu of a properly returned warranty registration card, the warranty period shall begin on the date of shipment to the authorized dealer. No other express or implied warranty is given by Ohaus Corporation. Ohaus Corporation shall not be liable for any consequential damages.

As warranty legislation differs from state to state and country to country, please contact Ohaus or your local Ohaus dealer for further details.



P/N 31092408 B © 2025 Ohaus Corporation, all rights reserved.