



PCAL100

Temperature Calibrator



CE

1 Safety Information

User should use the calibrator in accordance with the instructions of the manual, or the protective measures provided by the calibrator may be damaged. The Company is not responsible for any damage caused by failure to follow the safety warning information provided.

“**⚠WARNING**” indicates a situation or action that may pose a danger to the user. “Caution” indicates a situation or action that may cause damage to the calibrator or the equipment being tested. Please refer to Table 1 for an explanation of international electrical symbols used in the calibrator and the manual.

Table 1. International electrical symbols

	Grounding		Warning message
---	-----------	---	-----------------

⚠WARNING

To avoid electric shock or personal injury:

- Do not apply voltage exceeding the rated voltage indicated on the calibrator between terminals or between any terminal and ground.
- Before use, measure a known voltage to verify that the calibrator is working properly.

- Please follow all safety steps of the instrument.
- Do not use a damaged calibrator. Check the housing of the calibrator for cracks or missing plastic parts before use. Pay special attention to the insulation around the connector.
- Select the proper function and range according to the measurement requirements.
- Make sure that the battery door is securely closed before using the calibrator.
- Remove the test lead from the calibrator before opening the battery door.
- Check the test lead for damage or exposed metal, and if it is conductive. Damaged test lead should be replaced before using the instrument.
- When using the probe, please keep your fingers away from its metal contact and behind the finger protection device of the probe.
- When wiring, the common wire should be connected first and then the live test lead. During removal, the live test lead should be removed first.
- Do not use the instrument if it is malfunctioning, since protective measures may have been damaged. If in doubt, please send the instrument for repair.
- Do not use the instrument near explosive gases, vapors, or dust.
- The calibrator should be powered by 3 AA LR6 batteries, which should be properly installed in the instrument housing.
- Remove the test lead before switching between different measurement or output functions.
- Use the designated replacement parts when repairing the calibrator.
- To avoid incorrect readings that could result in electric shock or personal injury, the battery should be replaced immediately when the symbol “” appears on the display screen indicating low battery

2 Get to Know the Calibrator

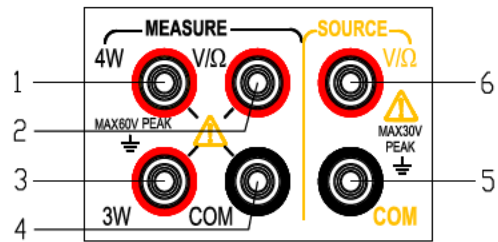
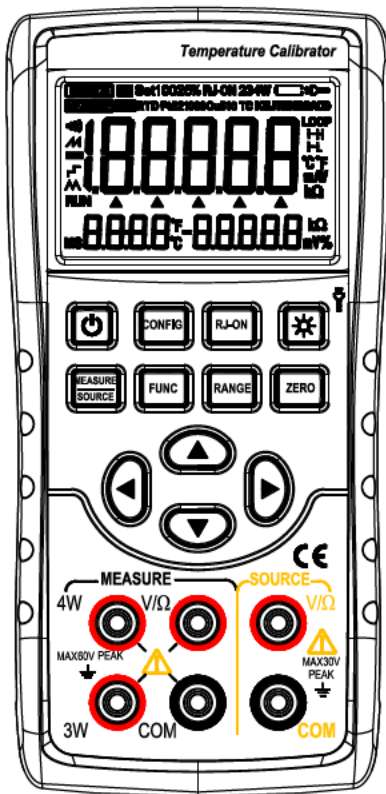

Figure 1. Overall diagram

2.1 Input and output terminals

Figure 2 shows the input and output terminals of the calibrator. Table 2 explains their purposes.

2. Input/output terminals

Terminal	Function description
1	4W terminal: 4-wire resistance measurement high-end SENSE
2	V Ω terminal: Input terminal for all measurement (+)
3	3W terminal: 4-wire resistance measurement low-end SENSE 3-wire resistance measurement SENSE terminal
4	COM terminal: Common (-)(return) terminal for all inputs
5	COM terminal: Common (-)(return) terminal for all outputs
6	V Ω terminal: Output terminal for all outputs(+)

Figure 2. Input/output terminals

5.2 Buttons

Figure 3 shows the calibrator buttons. Table 3 explains their functions.

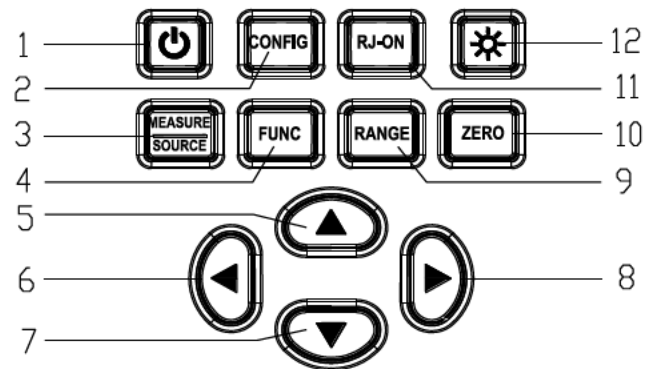

Figure 3. Button functions

Table 3. Button functions

SN	Button name	Description
1	Power button	Power on/off
2	CONFIG button	Configuration button: Set the wire system when inputting resistance; Set the excitation when outputting resistance; Set the compensation in TC function
3	MEASURE/SOURCE button	Input/output state switching
4	FUNC button	Input/output function switching
5, 7	Output setting button	Output setting position increases/decreases
6, 8	Output setting button	Output setting position shifts left/right
8	Output ZERO button	Reset the output value to the default value. Press this button to save the setting in factory maintenance setting function.
9	RANGE button	Select input/output range
10	ZERO button	Reset the output value to the default value. Press this button to save the setting in factory maintenance and configuration setting function.
11	RJ-ON button	Temperature compensation on/off
12	Backlight/flashlight button	Short press to turn on/off the backlight; long press to turn on/off the flashlight

5.3 Display screen

- a: Mark for instrument output working mode
- b: Mark for instrument measurement working mode
- c: On/off function mark
- d: Input/output value polarity mark
- e: Input/output value
- f: Output bit indicator
- g: Cold-end compensation temperature value
- h: Cold-end compensation temperature unit
- i: Voltage/resistance value corresponding to thermocouple/thermal resistance function
- j: Voltage/resistance unit corresponding to thermocouple/thermal resistance function
- k: Input/output value unit mark
- l: Output resistance excitation mark
- m: Thermocouple function mark
- n: Thermocouple range indicator
- o: Flashlight mark
- p: Battery status symbol
- q: Input resistance/thermal resistance wire system mark
- r: Mark for thermocouple cold-end compensation on
- s: Thermal resistance range indicator
- t: Thermal resistance function mark
- u: Signal connection mark

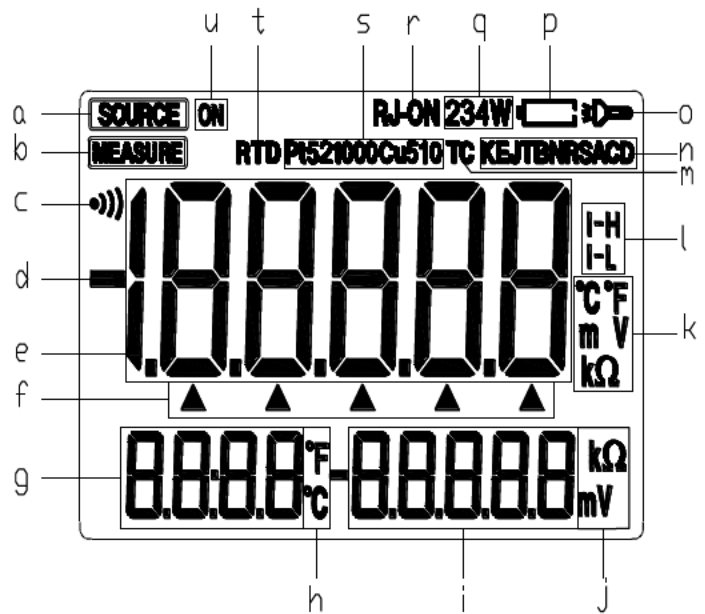

Figure 4. Typical display screen

6 Preparations

■ Operating precautions

Safe use for the calibrator

- When using the calibrator for the first time, be sure to read the safety information listed in Section IV.

- Do not open the instrument housing.

To inspect or repair the instrument's internal components, please contact the seller from whom you purchased the product.

- Malfunctioning conditions

If the instrument starts to release fume and emit a strange smell, or other abnormal phenomena occur, immediately turn off the instrument and remove the batteries. Then contact the seller from whom you purchased the instrument.

■ General operations

- Before moving the calibrator, turn off the power of the tested instrument and then the power of the calibrator. Finally, unplug all test leads from the calibrator. Use a professional transport packaging box when transporting the calibrator.
- Do not allow any live objects to approach the calibrator in case its internal circuitry gets damaged.
- Do not apply any volatile chemicals to the calibrator housing and operator panel, and do not leave the calibrator attached to any object made of rubber or vinyl for too long. Take care to prevent the operating panel, which is made of thermoplastic resin, from contacting soldering iron, soldering tin or heating objects.
- For safe operations of battery, please refer to the "Install or replace batteries" section.
- Do not use the calibrator without the battery cover installed.

■ Environmental requirements

Use the instrument under the environmental requirements listed below:

- Ambient temperature and humidity
Ambient temperature: 0-50°C

Ambient humidity: 20%-80%; use the instrument under non-condensing conditions

- Use the instrument in a flat and horizontal area
- Do not use the instrument in the following environment
- Places directly exposed to sunlight or close to heat sources
- Places close to mechanical vibrations
- Approaching to any interference source, such as high-voltage equipment or engine power
- Approaching to any electromagnetic field or high-density electric power area
- Places filled with large amounts of oil fumes, heat flow, dust or corrosive gases
- Unstable places or places with flammable gases that can cause an explosion

Note:

- If precise measurements or output results are required, use the calibrator under the following environmental requirements:
Ambient temperature range: $23\pm 5^{\circ}\text{C}$; ambient humidity range: 20-80% (without condensation)
When using the calibrator in an environment of $0-18^{\circ}\text{C}$ or $28-50^{\circ}\text{C}$, refer to the Index section and add an additional error value at this temperature coefficient to achieve the given accuracy.
- When the humidity of the surrounding environment where the instrument is located is less than 30%, use an anti-static pad or take other effective measures to prevent the generation of static electricity.
- If the instrument needs to be moved from a place with lower ambient temperature or humidity to a place with higher ambient temperature, or if the instrument is to undergo a sudden temperature change, warm up the instrument for at least one hour under the ambient temperature before using to ensure its proper operation.
- Install or replace batteries

WARNING

- To avoid electric shock, the test lead must be removed from the calibrator before opening the battery door. The battery door must be closed tightly before using the calibrator.

Caution

- To prevent the risk of liquid leakage or battery explosion, install the positive and negative poles of the battery correctly.

- ⚠ ● Do not short-circuit the battery.
- Do not disassemble or heat the battery, or throw the battery into a fire.
- When replacing batteries, use 3 identical batteries to replace them simultaneously.
- If the calibrator will not be used for an extended period of time, remove the batteries from the calibrator.

Step 1: Before replacing the battery, remove the test leads and charger, and turn off the calibrator.

Step 2: Use a slotted screwdriver to rotate the battery door screw by a quarter turn counterclockwise and remove the battery door.

Step 3: Correctly install 3 AA LR6 alkaline batteries into the battery compartment in the direction as it indicates.

Step 4: After replacing the batteries, close the battery door tightly again.

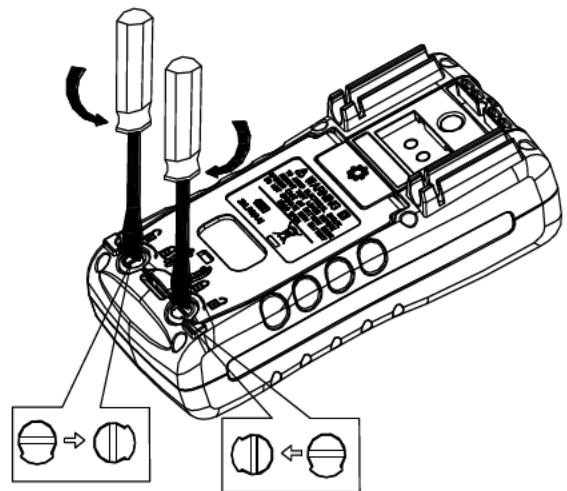

Figure 5

- Power on/off

Press the Power button to turn on the calibrator when the power is off; Press the Power button for 2 seconds to turn off the calibrator when it is on.

- Automatic shutdown

The calibrator automatically shuts down when there is no button operation within the factory default of 5 minutes. The automatic shutdown time can be set in the factory settings. Please refer to Chapter 9 “Factory Settings”.

- Turn backlight on/off

Press the Backlight button to turn the backlight on, and press it again to turn the backlight off. This makes it easier to see the content on the display screen in dark places or when performing outputs or measurements. Turning on the backlight will reduce the battery life when the calibrator is operating on batteries.

Note

The backlight automatically turns off after a default of approximately 60 seconds. Press the Backlight button to re-illuminate backlight. The backlight illumination time can be set in the factory settings. Please refer to Chapter 9 “Factory Settings”.

7 Utilize the Output Mode

⚠ Warning

Do not apply voltage exceeding the rated voltage between the terminals of the calibrator or between any terminal and the ground indicated on the calibrator or use the calibrator in any case where the terminal to ground voltage should not exceed the peak value of 30V in order to avoid electric shock.

7.1 Connect leads to output terminals

Connection method of all outputs (Figure 6)

Step 1: Connect the black lead to the COM end of the output and the red lead to the 'V/Ω' end of the output.

Step 2: Connect the other end of the two leads to the input end of the controlled device and ensure that the terminal polarity is correct.

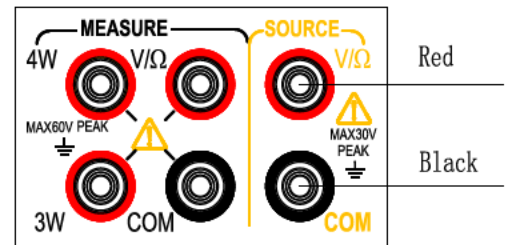

Figure 6. Output Mode

7.2 Output DC voltage

Step 1: Press (MEASURE/SOURCE) button to switch to the output state and (SOURCE) sign of the display screen will light up. The default is DC voltage function with a measurement range of 100mV at this moment. The character mV on the right side of the main display area of the LCD display screen will light up.

Step 2: Press (RANGE) button for choosing proper measurement range (100mV,1V)

Step 3: Use output setting button to set the output value.

Change the output setting bit: (◀) / (▶)

Change the output value: (▲) / (▼)

Tip: The (ZERO) button can be pressed to set the output setting to the default initial value (0).

7.3 Analog output resistance

Step 1: Press (**FUNC**) button to switch the function to the analog resistance function and the character Ω on the right of the main display area of the LCD display screen will light up.

Step 2: Press (**RANGE**) button to switch to the required measurement range (400 Ω / 4K Ω).

Measurement range of 400 Ω offers two excitation currents (1mA /0.1mA) that users can manually change according to their demands for more accurate analog resistance;

Excitation current setting: Press (**CONFIG**) button to enter the excitation current setting interface. The secondary display area at the lower right corner of the display screen displays OHM.IS at this moment and the characters (I-H stands for 1mA, I-L stands for 0.1mA) corresponding to the excitation current are displayed in the main display area. Press (**▲**) / (**▼**) button to change the excitation and press (**ZERO**) button to save the settings; Press (**CONFIG**) button to exit the settings.

Step 3: Use output setting button to set the output value.

Change the output setting bit: (**▲**) / (**▼**)

Change the output value: (**◀**) / (**▶**)

Tip: The excitation current prompt on the right side of the main display area will flash if the excitation current does not match and it is required to enter the setting interface to change the excitation current at this moment in the case of the measurement range of 400 Ω .

7.4 Analog output thermocouple

Step 1: Press (**FUNC**) button to switch to the function of analog couple and the character TC in the upper right corner of the display screen will light up.

Step 2: Press (**RANGE**) button to switch the required division (R/S/K/E/J/T/N/B/A/C/D).

Step 3: Press (**RJ-ON**) to turn on the cold end compensation function if cold end compensation is required; Skip this step if cold end compensation is not required.

The cold end compensation method is divided into manual temperature and automatic temperature. The temperature of automatic temperature is the actual ambient temperature collected by the temperature sensor of the instrument itself. Manual

temperature indicates the temperature set by the user.

The method of setting the cold end compensation: Press (CONFIG) button to enter the cold end compensation setting interface and RJST is displayed in the secondary display area at the lower right corner of the display screen at this moment, indicating the compensation mode setting; The main display area displays the compensation setting parameters (MANU stands for manual temperature compensation and AUTO stands for automatic temperature compensation) 'Press (▲) / (▼) button to change the setting; Press (ZERO) button to save the settings and switch to the manual temperature compensation temperature setting interface and the secondary display area at the lower right corner of the display screen displays RJVA at this moment. The main display area displays the temperature to be set. The temperature setting range is -10~50 and the required temperature is set by using (▲) / (▼) / (◀) / (▶) ; Press (ZERO) button to save the settings and switch the settings; Press (CONFIG) button to exit the settings.

Tip: For automatic temperature cold compensation method, the lower left corner of the display screen shows the actual temperature of the current environment; The manual temperature compensation method displays the compensation temperature set by the user and the M character is lit.

Step 4: Use output setting button to set the output value.

Change the output setting bit: (▲) / (▼)

Change the output value: (◀) / (▶)

7.5 Analog output thermal resistance

Step1: Press (FUNC) button to switch the function to the analog thermal resistance output function and the character RTD in the upper left corner of the display screen will light up.

Step2: Press (RANGE) button to switch to the required division (PT100/PT200/PT500/PT1000/Cu50) .

PT100 and Cu50 divisions provide two excitation currents (1mA /0.1mA) which can be manually changed by the user according to demands for more accurate analog thermal resistance;

Excitation current setting: Press (CONFIG) button to enter the interface for setting excitation current. OHMI.S is displayed

in the secondary display area at the lower right corner of the display screen at this moment and the characters (I-H stands for 1mA and I-L stands for 0.1mA) corresponding to excitation current are displayed in the main display area. Press (▲) / (▼) button to change the excitation and press (ZERO) button to save the settings; Press (CONFIG) button to exit the settings.

Step3: Use output setting button to set the output value.

Change the output setting bit: (▲) / (▼)

Change the output value: (◀) / (▶)

Tip: Excitation current prompt on the right side of the main display area will flash if excitation current does not match in the case of the divisions of PT100 and Cu50. It is required to enter the setting interface to change excitation current at this moment.

7.6 Reset function

- The (ZERO) button can be pressed to conduct clearing operation in any measurement range of DC voltage, resistance, thermocouple, thermal resistance output function to change the output setting value to the default initial value. It is convenient for users to reset the output value.

8 Utilize the Measurement Mode

⚠ Warning

- The measurement function of the calibrator is used where a lead connection is required. The maximum voltage of any input terminal to ground is 60V peak. Do not apply any voltage above the maximum voltage to the terminal to the ground in order to avoid electric shock.

Tip

- The “OL” symbol is displayed in the main display area of the display screen when the measured value exceeds the measurement range of this range.

8.1 Connect leads to input terminals

Connection method of DC voltage, thermocouple, thermal resistance, resistance (2W) measurement (Figure 7)

Step1: Connect the black lead to the 'COM' end of the input and the red lead to the 'V Ω ' end of the input.

Step2: Connect the other end of the two leads to the measurement end of the device under test and ensure that the terminal polarity is correct.

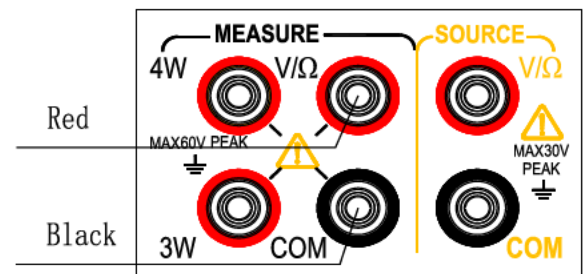

Figure 7. Measure DC voltage, thermocouple, thermal resistance and resistance (2W)

Connection method of resistance (3W) and thermal resistance (3W) measurement (Figure 8)

Step 1: Connect the black lead to the 'COM' end of the input, the red lead to the 'V Ω ' end of the input and the 3W lead to the '3W' end.

Step 2: Connect the other end of the three leads to the measurement end of the device under test respectively and ensure that the terminal polarity is correct.

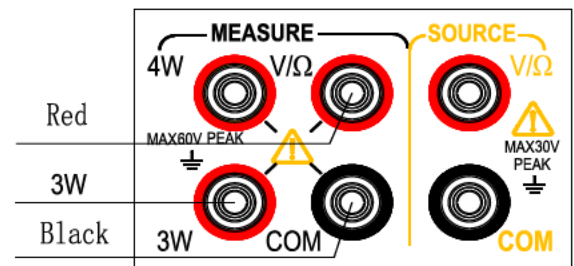

Figure 8 Resistance, RTD measurement (3W)

Connection method of resistance (4W) and thermal resistance measurement (4W) (Figure 9)

Step 1: Connect the black lead to the 'COM' end of the input, the red lead to the 'V/Ω' end of the input, the 3W lead to the '3W' end of the input and the 4W lead to the '4W' end of the input.

Step 2: Connect the other end of the four leads to the measurement end of the device under test respectively and ensure that the terminal polarity is correct.

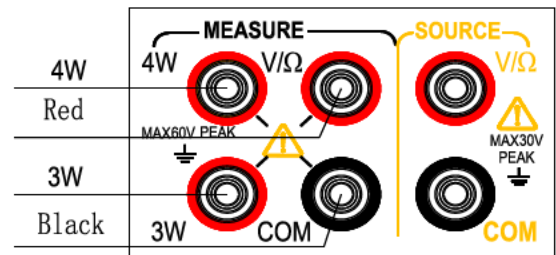

Figure 9 Resistance, RTD measurement (4W)

⚠ Warning

Disconnect the power supply of the device before connecting the calibrator to the device under test.

Incorrect operation of the circuit or during measurement may cause damage to the instrument or injury to people. Therefore, pay as much attention as possible when performing measurement operations.

8.2 Measurement of DC voltage

Step 1: Ensure the measurement lead is disconnected from the device under test.

Step 2: Press (MEASURE/SOURCE) button to switch to the measurement state and the (MEASURE) mark on the display screen will light up. The default is DC voltage function at this moment with a measurement range of 100mV and the mV character on the right side of the main display area of the LCD display screen will light up.

Step 3: Press (RANGE) button to switch to the required range (100mV, 1V, 30V).

Step 4: Connect the measurement lead to the measured end of the device under test and the measurement value is displayed in the main display area.

8.3 Measurement of resistance

Step 1: Ensure the measurement lead is disconnected from the device under test.

Step 2: Press (**FUNC**) button to switch to the resistance function and the Ω character on the display screen will light up.

Step 3: Press (**RANGE**) button to switch the required measurement range (500 Ω / 5K Ω).

Step 4: Set the resistance wire system: Press (**CONFIG**) button to enter the wire system setting interface. The secondary display area in the lower right corner of the display screen displays Wire System at this moment and the wire system (2W/3W/4W) is displayed in the main display area. Choose the proper wire system using (\blacktriangle) / (\blacktriangledown), press (**ZERO**) button to save the setting and press (**CONFIG**) button to exit the setting.

Step 5: Connect the measurement lead to the measurement end of the device under test and the measurement value is displayed in the main display area of the display screen.

8.4 Measurement of thermocouple

Step 1: Ensure the measurement lead is disconnected from the device under test.

Step 2: Press (**FUNC**) button to switch to the thermocouple function and the TC character on the display screen will light up.

Step 3: Press (**RANGE**) button to switch the required divisions (R/S/K/E/J/T/N/B/A/C/D).

Step 4: Press (**RJ-ON**) button to enable the cold end compensation function if cold end compensation is required; Skip this step if cold end compensation is not required.

The cold end compensation method is divided into manual temperature and automatic temperature. The temperature of automatic temperature is the actual ambient temperature collected by the temperature sensor of the instrument itself. Manual temperature indicates the temperature set by the user.

The method of setting cold end compensation: Press (**CONFIG**) button to enter the cold end compensation setting interface. RJST is displayed in the secondary display area at the lower right corner of the display screen at this time, indicating the compensation method setting; The main display area displays the compensation setting parameters (MANU stands for manual temperature compensation and AUTO stands for automatic temperature compensation) 'Press (\blacktriangle) / (\blacktriangledown) button to

change the setting; Press (**ZERO**) button to save the settings and switch to the manual temperature compensation temperature setting interface. The secondary display area at the lower right corner of the display screen displays RJVA at this time. The main display area displays the temperature to be set. The temperature setting range is -10~50 and the required temperature is set using (▲) / (▼) / (◀) / (▶) ; Press (**ZERO**) button to save the settings and switch the settings; Press (**CONFIG**) button to exit the settings.

Tip: For automatic temperature cold compensation method, the lower left corner of the display screen shows the actual temperature of the current environment; The manual temperature compensation method displays the compensation temperature set by the user and the M character is lit.

Step 5: Connect the measurement lead to the measurement end of the device under test and the measurement value is displayed in the main display area of the display screen.

8.5 Measurement of thermal resistance

Step 1: Ensure the measurement lead is disconnected from the device under test.

Step 2: Press (**FUNC**) button to switch to the thermal resistance function and the RTD character of the display screen will light up.

Step 3: Press (**RANGE**) button to switch to required division (PT100 / PT200 / PT500 / PT1000 / Cu50).

Step 4: Set the thermal resistance wire system: Press (**CONFIG**) button to enter the wire system setting interface. WRIE is displayed in the lower right corner of the display screen at this moment and the wire system (2W/3W/4W) is displayed in the main display area. Choose the proper wire system using (▲) / (▼) , press (**ZERO**) button to save the setting and press (**CONFIG**) button to exit the setting.

Step 5: Connect the measurement lead to the measurement end of the device under test and the measurement value is displayed in the main display area of the display screen.

9 Factory Settings

The calibrator can have changes of the default factory settings.

To enter: Press and hold the Backlight button, and then press the Power button to turn on the instrument. After the instrument enters the settings interface, release the Backlight button.

9.1 Automatic shutdown time setting

Step 1: After entering the settings interface, you will find “APOF” shown on the display screen, which indicates the automatic shutdown setting.

Step 2: Use the setting buttons (▲) / (▼) / (◀) / (▶) to set the required parameters. The display unit of automatic shutdown time is minute.

Setting range: 0-60 minutes; 0 represents canceling the automatic shutdown, while other values represent the corresponding time after which the instrument will shut down

Step 3: Press (ZERO) button, and the display screen will show “SAVE”, indicating that the setting has been saved.

9.2 Backlight time setting

Step 1: Press (CONFIG) button to make the display screen show “BLOF”, which indicates the backlight time setting.

Step 2: Use (▲) / (▼) / (◀) / (▶) to set the required parameters. The display unit of backlight time is second.

Setting range: 0-3600 seconds; 0 represents canceling the automatic backlight shutdown, other values represent the corresponding time after which the instrument backlight will shut down.

Step 3: Press (ZERO) button, and the display screen will show “SAVE”, indicating that the setting has been saved.

9.3 Flashlight time setting

Step 1: Press (CONFIG) button to make the display screen show “LTOF”, which indicates the flashlight time setting.

Step 2: Use (▲) / (▼) / (◀) / (▶) to set the required parameters. The display unit of flashlight time is minute.

Setting range: 0-30 minutes; 0 represents canceling the automatic backlight shutdown, other values represent the corresponding time after which the instrument backlight will shut down.

Step 3: Press (ZERO) button, and the display screen will show “SAVE”, indicating that the setting has been saved.

9.4 Buzzer setting

Step 1: Press (CONFIG) button to make the display screen show “BEEP”, which indicates the beep setting.

Use (▲) / (▼) to set the required parameters;

ON indicates that the beep function is on, while OFF indicates that the beep function is off.

Step 3: Press (ZERO) button, and the display screen will show “SAVE”, indicating that the setting has been saved.

9.5 Temperature unit setting

Step 1: Press (CONFIG) button to make the display screen show “TEPU”, which indicates the temperature unit setting.

Step 2: Use (▲) / (▼) to set the required parameters;

C indicates that the temperature unit is Celsius, while F indicates that the temperature unit is Fahrenheit.

Step 3: Press (ZERO) button, and the display screen will show “SAVE”, indicating that the setting has been saved.

9.6 Factory default setting

Step 1: Press (**CONFIG**) button to make the display screen show “FACT”, which indicates the factory default setting.

Step 2: Use (▲) / (▼) to set the required parameters;

NO indicates that all settings are not restored to factory parameters, while YES indicates that all settings are restored to factory parameters.

Step 2: Press (**ZERO**) button, and the display screen will show “SAVE”, indicating that the setting has been saved.

All settings of the factory parameters are as follows:

APOF: 5 minutes.

BLOF: 60 seconds.

LTOF: 5 minutes.

BEEP: ON

TEPU: C

Tip: Whenever you change the setting of any item, there is a need to press (**ZERO**) button to save the set value. Any press of the (**ZERO**) button will only save the latest set value.

10 Replace the Battery

⚠ WARNING

To avoid electric shock, the test lead must be removed from the calibrator before opening the battery door. The battery door must be closed tightly before using the calibrator.

Caution

- To prevent the risk of liquid leakage or battery explosion, install the positive and negative poles of the battery correctly.
- Do not short-circuit the battery.
- Do not disassemble or heat the battery, or throw the battery into a fire.
- When replacing batteries, use 3 identical batteries to replace them simultaneously.
- If the calibrator will not be used for an extended period of time, remove the batteries from the calibrator

Step 1: Before replacing the battery, remove the test leads and turn off the calibrator.

Step 2: Use a slotted screwdriver to rotate the battery door screw by a quarter turn counterclockwise and remove the battery door, as shown in Figure 10.

Step 3: Correctly install 3 same AA LR6 batteries into the battery compartment in the direction as it indicates

Step 4: After replacing the batteries, close the battery door and fasten the screw tightly again.

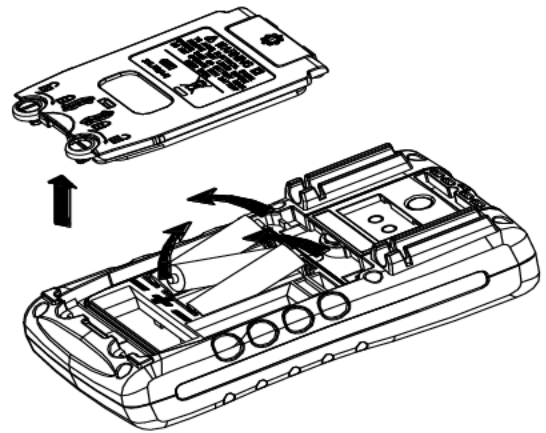

Figure 10. Replace the battery

11 Maintenance

11.1 Clean the calibrator

⚠WARNING

Designated replacement parts should be used to avoid personal injury or damage to the calibrator. Do not allow water to enter the housing.

Caution

Do not use solvent or abrasive cleaner to avoid damage to the plastic lens and housing. Clean the calibrator with a soft cloth dampened with a little water or mild soapy water.

11.2 Service center for calibration or repair

Calibration, repair or maintenance of the instrument should only be carried out by experienced maintainer. Check the battery first if the calibrator is malfunctioning, and replace it if necessary.

Make sure that the calibrator is operated in line with the instructions in this manual. If there is a malfunction with the calibrator, please send it back accompanied by a fault description. If you still keep the original packing box, please send the calibrator to your nearest service center with strong packing (please pay for postage and insurance). The Company does not assume responsibility for any damage caused by transportation.

Calibrators guaranteed by the Company can be repaired or replaced quickly (at our Company's discretion) and sent back free of charge. Please refer to the guarantee clause in this manual. If the warranty period has expired, there will be a certain fee for repairing the calibrator. If the calibrator is not included in the guarantee item, please contact an authorized service center of the Company to inquire about repairs and fees. To find an authorized service center, please refer to the section "Contact Us" at the front of the manual.

12 Index

Input measurement function [Used within one year after calibration, 23°C±5°C, 20-70% RH, accuracy = ± (% set value + reading)]

Measurement function	Range	Measurement range	Resolution	Accuracy	Remarks
DC voltage DCV	100mV	-110.000mV~110.000mV	0.01mV	0.05%+0.03mV	Input resistance: approximately 1MΩ
	1V	-1.1000V~1.1000V	0.0001V	0.05%+0.3mV	
	30V	-30.000V~30.000V	0.001V	0.02%+2mV	
Resistance OHM	500Ω	0~550.00Ω	0.01Ω	0.05%+0.2Ω	2W/3W/4W measurement 500Ω approximately 1mA excitation 5KΩ approximately 0.1mA excitation Open circuit voltage: approximately 2.5V The accuracy does not include lead resistance
	5KΩ	0~5.5000KΩ	0.0001KΩ	0.05%+2Ω	

Thermocouple TC	R	0°C~1767°C	1°C	0.05%+3°C (less than or equals to 100°C)	Use ITS-90 temperature scale The accuracy does not include the error of cold-end compensation The accuracy does not include sensor inaccuracy The accuracy does not include the influence of thermoelectric potential The materials corresponding to the calibrations on the left are as follows: R: Platinum Rhodium 13-Platinum S: Platinum Rhodium 10-Platinum K: Nickel chromium - nickel silicon E: Nickel chromium -
	S	0°C~1767°C		0.05%+2°C (more than 100°C)	
	K	-100.0°~1372.0°C	0.1°C	0.05%+2°C (less than or equals to -100°C)	
	E	-50.0°C~1000.0°C		0.05%+1°C (more than -100°C)	
	J	-60.0°C~1200.0°C			
	T	-100.0°C~400.0°C			

	N	-200.0°~1300.0°C			0.05%+3°C	copper nickel (constantan) J: Iron - copper nickel (constantan) T: Copper - copper nickel (constantan) N: Nickel chromium silicon - nickel silicon B: Platinum Rhodium 30 - Platinum A: Tungsten rhenium 5- Tungsten rhenium 20 C: Tungsten rhenium 5- Tungsten rhenium 26 D: Tungsten rhenium 3- Tungsten rhenium 25
	B	600°C~1820°C	1°C			
	A	0°C~2500°C	1°C			
	C	0°C~2310°C	1°C			
	D	0°C~2310°C	1°C			
Thermal resistance RTD	Pt100 385	-200.0°C~800.0°C	0.1°C	0.05%+0.6°C	Use Pt (385) temperature scale	

(3W)	Pt200 385	-200.0°C~630.0°C			2W/3W/4W measurement 500 Ω approximately 1mA excitation 5K Ω approximately 0.1mA excitation Open circuit voltage: approximately 2.5V The accuracy does not include the error caused by the mismatch of the 2 W/3 W measurement lead resistance The accuracy does not include sensor inaccuracy The accuracy does not include the influence of thermoelectric potential
	Pt500 385	-200.0°C~630.0°C			
	Pt1000 385	-200.0°C~630.0°C			
	Cu50	-50.0°C~150.0°C			
On/off detection	500 Ω	≤50 Ω sounding	0.01 Ω		Approximately 1mA excitation

Other characteristics:

- Uncertainty includes standard uncertainty, hysteresis, nonlinearity, repeatability, and typical long-term stability over the period mentioned ($K = 2$).
- Display refresh rate: 2-3 times / second.
- Maximum applied voltage at input terminal: 60 Vpk.
- Input common-mode rejection: 50Hz /60 Hz > 80 db; Input serial-mode rejection: 50Hz /60 Hz > 40 db
- Temperature coefficient: $0.1 \times$ basic accuracy / °C (temperature range <18°C or >28°C)

Analog output function [Used within one year after calibration, 23°C±5°C, 20-70% RH, accuracy = ± (% set value + reading)]

Output function	Range	Output range	Resolution	Accuracy	Remarks
DC voltage DCV	100mV	-10.000mV~110.00mV	0.01mV	0.05%+0.03mV	Maximum output current: 0.5mA
	1V	-0.1000V~1.1000V	0.0001V	0.05%+0.3mV	Maximum output current 2mA
Ohm OHM	400 Ω	0~400.0 Ω	0.1 Ω	0.05%+0.2 Ω	The excitation current is ±0.1 - ±5mA Maximum output voltage 2V When the excitation current is ±0.1 - 0.5mA, additional error of 0.3 Ω is added The accuracy does not include lead resistance
	4K Ω	0~4.000K Ω	1 Ω	0.05%+2 Ω	
Thermocouple TC	R	0°C~1767°C	1°C	0.05%+3 (less than or equals to	Use ITS-90 temperature scale The accuracy does not include the error of cold-end

	S	0°C~1767°C		100°C) 0.05%+2 (more than 100°C)	compensation The accuracy does not include sensor inaccuracy The accuracy does not include the influence of thermoelectric potential The materials corresponding to the calibrations on the left are as follows: R: Platinum Rhodium 13-Platinum S: Platinum Rhodium 10-Platinum K: Nickel chromium - nickel silicon E: Nickel chromium - copper nickel (constantan) J: Iron - copper nickel (constantan) T: Copper - copper nickel (constantan)
	K	-200.0°C~1372.0°C	0.1°C	0.05%+20 (less than or equals to -100°C) 0.05%+10 (more than -100°C)	
	E	-200.0°C~1000.0°C			
	J	-200.0°C~1200.0°C			
	T	-250.0°C~400.0°C			
	N	-200.0°C~1300.0°C			

	B	600°C~1820°C	1°C	0.05%+3	N: Nickel chromium silicon - nickel silicon B: Platinum Rhodium 30 - Platinum A: Tungsten rhenium 5- Tungsten rhenium 20 C: Tungsten rhenium 5- Tungsten rhenium 26 D: Tungsten rhenium 3- Tungsten rhenium 25
	A	0°C~2500°C	1°C		
	C	0°C~2310°C	1°C		
	D	0°C~2310°C	1°C		
Thermal resistance RTD	Pt100 385	-200.0°C~800.0°C	0.1°C	0.05%+0.6°C	Use Pt (385) temperature scale The excitation current is $\pm 0.1 - \pm 5\text{mA}$ Maximum output voltage 2V When the excitation current is $\pm 0.1 - 0.5\text{mA}$, additional
	Pt200 385	-200.0°C~630.0°C			
	Pt500 385	-200.0°C~630.0°C			

	Pt1000 385	-200.0°C~630.0°C			error of 0.3Ω is added The accuracy does not include lead resistance The accuracy does not include the influence of thermoelectric potential
	Cu50	-50.0°C~150.0°C			

Other characteristics:

- Uncertainty includes standard uncertainty, hysteresis, nonlinearity, repeatability, and typical long-term stability over the period mentioned (K = 2).
- Maximum applied voltage at output terminal: approximately 30Vpk; Maximum applied current at output terminal: approximately 25mA
- Temperature coefficient: 0.1 × basic accuracy/°C (temperature range < 18°C or > 28°C)

Warranty

Triplett Test Equipment and Tools extends the following warranty to the original purchaser of these goods for use. Triplett warrants to the original purchaser for use that the products sold by it will be free from defects in workmanship and material for a period of (1) one year from the date of purchase. This warranty does not apply to any of our products which have been repaired or altered by unauthorized persons in any way or purchased from unauthorized distributors so as, in our sole judgment, to injure their stability or reliability, or which have been subject to misuse, abuse, misapplication, negligence, accident or which have had the serial numbers altered, defaced, or removed. Accessories, including batteries are not covered by this warranty

Copyright © 2024 Triplett

