

# Quick Start Manual



Read the user's manual carefully before starting to use the unit.  
Producer reserves the right to implement changes without prior notice.

# Truflo® — TKM Series

## In-Line Paddle Wheel Flow Meter Sensor

### Safety Information

- De-pressurize and vent system prior to installation or removal
- Confirm chemical compatibility before use
- **DO NOT** exceed maximum temperature or pressure specifications
- **ALWAYS** wear safety goggles or face-shield during installation and/or service
- **DO NOT** alter product construction



#### Warning | Caution | Danger

Indicates a potential hazard. Failure to follow all warnings may lead to equipment damage, injury, or death.



#### Personal Protective Equipment (PPE)

Always utilize the most appropriate PPE during installation and service of Truflo products.



#### Note | Technical Notes

Highlights additional information or detailed procedure.



#### Pressurized System Warning

Sensor may be under pressure. Take caution to vent system prior to installation or removal. Failure to do so may result in equipment damage and/or serious injury.



#### Please ensure that the Instruments are not to be subject to water hammer or pressure spikes! Always Pressure Test System with H2O Prior to Initial Start-Up

Before installation be certain the appropriate instrument has been selected considering operating pressure, full scale pressure, wetted material requirements, media compatibility, operating temperature, vibration, pulsation, desired accuracy and any other instrument component related to the service application including the potential need for protective attachments and/or special installation requirements. Failure to do so could result in equipment damage, failure and/or personal injury. Ensure only qualified personnel are permitted to install and maintain this instrument.



#### Pressurize System Warning

Sensor may be under pressure, take caution to vent system prior to installation or removal. Failure to do so may result in equipment damage and/or serious injury.



#### Please Ensure Full Pipe

TK Series can be installed in a horizontal or vertical direction. Please ensure enough length of straight pipe to avoid intensified turbulent flow that can effect readings.

#### Min 10x Pipe Diameters Upstream 3x Pipe Diameters Downstream (See Page 11)

A Bag Filter or Y Strainer Filtering Device upstream to Avoid the Paddle Wheel from being damaged by the solids or fibers - max 10% Particle Size - Not to Exceed .5mm Cross Section or Length. Please do not flush the pipe after the Flow Meter is installed with compressed air this may damage the ceramic shaft and will void warranty.

# Truflo® — TKM Series In-Line Paddle Wheel Flow Meter Sensor

## Product Description

The TK Series in-line plastic paddle wheel flow meter has been engineered to provide long-term accurate flow measurement in tough industrial applications.

The paddle wheel assembly consists of an engineered Tefzel® paddle and micro-polished zirconium ceramic rotor pin and bushings. High performance Tefzel® and Zirconium materials have been selected due to their excellent chemical and wear resistant properties.

## New ShearPro® Design

- ✓ Contoured Flow Profile
- ✓ Reduced Turbulence = Increased Longevity
- ✓ 78% Less Drag than Old Flat Paddle Design\*

\*Ref: NASA "Shape Effects on Drag"

## Tefzel® Paddle Wheel

- ✓ Superior Chemical And Wear Resistance vs PVDF

## Zirconium Ceramic Rotor | Bushings

- ✓ Up to 15x the Wear Resistance vs Regular Ceramic
- ✓ Integral Rotor Bushings Reduce Wear and Fatigue Stress

## ShearPro® Through-Pin Design

- ✓ Eliminates Finger Spread
- ✓ No Lost Paddles
- ✓ Increased Temp. Rating
- ✓ 360° Housing Protects Rotor



ShearPro® vs. Competitor 'A'

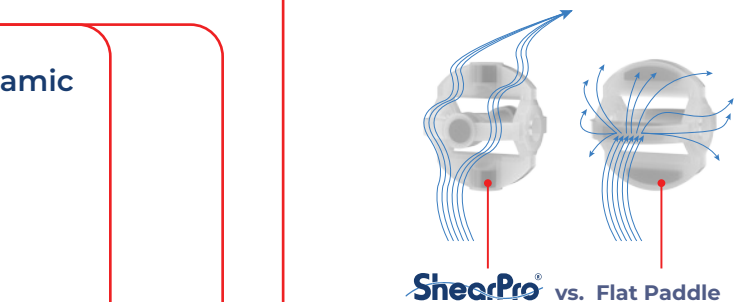

ShearPro® vs. Flat Paddle

TKM Thermal Plastic

TK3M 316 SS

# Truflo® — TKM Series

## In-Line Paddle Wheel Flow Meter Sensor

### Technical Specifications

General		
Operating Range	0.3 to 33 ft/s	0.1 to 10 m/s
Pipe Size Range	¼ to 4" **	DN08 to DN100
Linearity	±0.5% of F.S @ 25°C   77°F	
Repeatability	±0.5% of F.S @ 25°C   77°F	
Fluid	Water or Chemical Liquid-Viscosity Range: .5-20 centistokes	
Flow Velocity	10 m/s max.	
Low Cut	0.3 m/s min.	
Operating Pressure	150 Psi (10 Bar) @ Ambient Temp.   Non-Shock	
Range Ability	10 : 1	
Response Time	Real Time	
Flow Total Meter	Range = 0~999999 ; Unit = Gallon or Liter or Ton (KL) Selectable	
Repeatability	Range = 0.0~999.9 ; Unit = GPM or LPM or CMH Selectable	
Accuracy	± 0.5% of F.S. @ 25°C	
Wetted Materials		
Sensor Body	PVC (Dark)   PP (Pigmented)   PVDF (Natural)   316 SS	
O-Rings	FKM   EPDM*   FFKM*	
Rotor Pin   Bushings	Zirconium Ceramic   ZrO <sub>2</sub>	
Paddle   Rotor	ETFE Tefzel®	
Electrical		
Frequency	49 Hz per m/s nominal	15 Hz per ft/s nominal
Supply Voltage	9 to 30 VDC ±10% regulated	
Supply Current	<1.5 mA @ 3.3 to 6 VDC	<20 mA @ 6 to 24 VDC
Max. Temperature/Pressure Rating – Standard and Integral Sensor   Non-Shock		
PVC	180 Psi @ 68°F   40 Psi @ 140°F	12.5 Bar @ 20°C   2.7 Bar @ 60°C
PP	180 Psi @ 68°F   40 Psi @ 190°F	12.5 Bar @ 20°C   2.7 Bar @ 88°C
PVDF	200 Psi @ 68°F   40 Psi @ 240°F	14 Bar @ 20°C   2.7 Bar @ 115°C
316 SS	Consult Factory	
Operating Temperature		
PVC	32°F to 140°F	0°C to 60°C
PP	-4°F to 190°F	-20°C to 88°C
PVDF	-40°F to 240°F	-40°C to 115°C
316 SS	-40°F to 300°F	-40°C to 149°C
Outputs		
TKM Series	NPN Pulse   4-20mA Outputs	
Standards and Approvals		
CE   FCC   RoHS Compliant		

See Temperature and Pressure Graphs for more information

\*Optional  
\*\* ¼" - ¾" SS Only

# Truflo® — TKM Series

## In-Line Paddle Wheel Flow Meter Sensor

### Exploded View

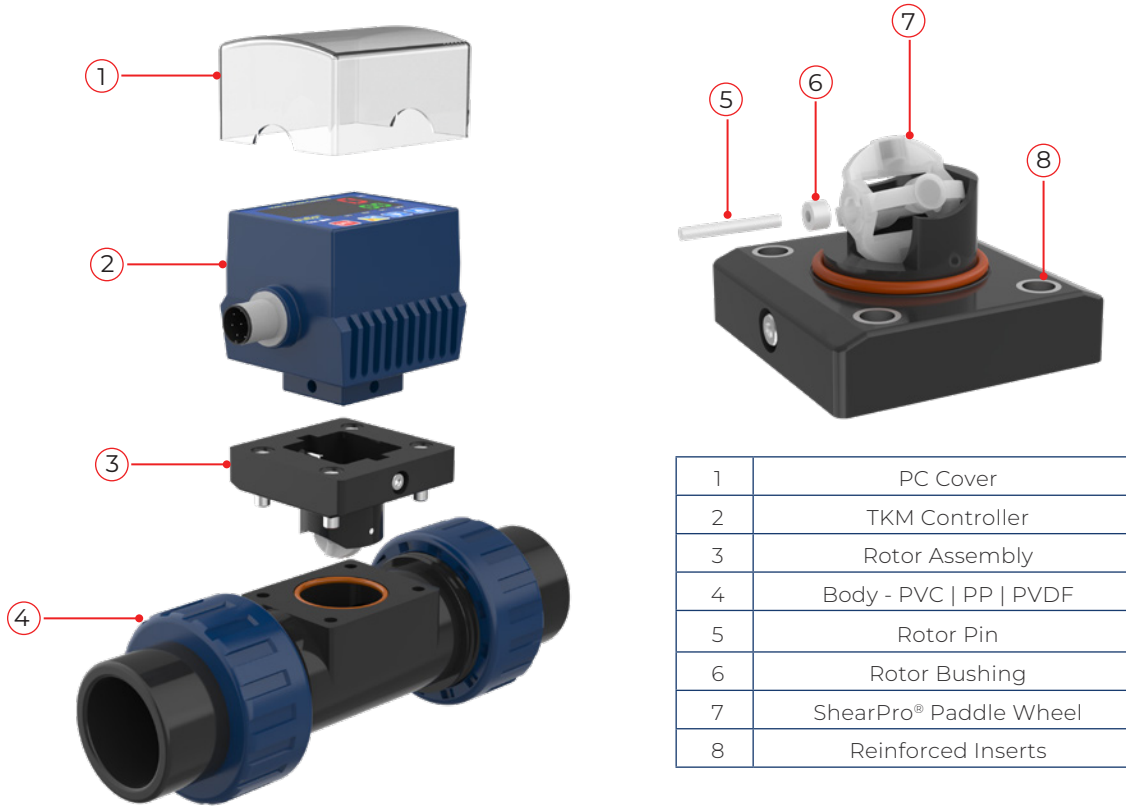

1	PC Cover
2	TKM Controller
3	Rotor Assembly
4	Body - PVC   PP   PVDF
5	Rotor Pin
6	Rotor Bushing
7	ShearPro® Paddle Wheel
8	Reinforced Inserts

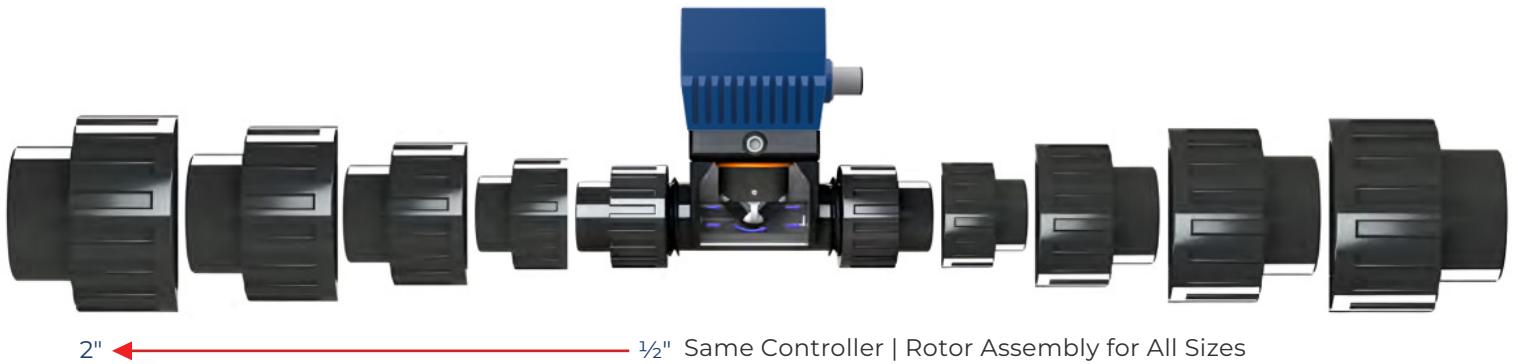

### Wiring Diagram

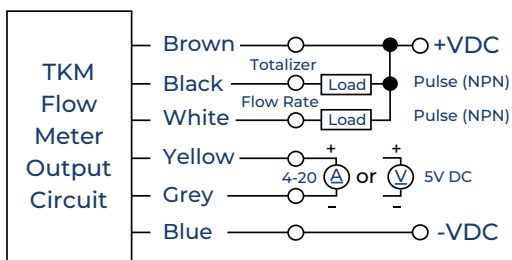

Wire Color	Description
Brown	+ 10~30VDC
Black	Totalizer Pulse Output (OP2)
White	Flow Rate Pulse Output (OP1)
Yellow	+ 4-20mA   0-5V*
Grey	- 4-20mA   0-5V*
Blue	-VDC

\* Optional

# Truflo® — TKM Series

## In-Line Paddle Wheel Flow Meter Sensor

### Programming



Select/Save/Continue



Move Selection Left



Change Digit Value

STEPS	DISPLAY	OPERATION
<p>1 Home Screen</p>		Home Screen
<p>2 Password</p>		Factory Default: Lk = 10 Otherwise meter will enter <b>Lockout Mode*</b> Press  /  to change Press <b>SET</b> to save
<p>3 Units of Flow</p>		Ut.0 = Liter   Ut.1 = Gallon (Factory Default)   Ut.2 = Kiloliters Press  to change Press <b>SET</b> to save
<p>4 K Factor</p>		Enter K Factor Value Refer to Page 9 for K-Factor Values
<p>5 Transmitter Range</p>		Factory Default — 4mA = 0   20mA = 100** (Max. Flow Rate) **This can be changed to suit application
<p>6 Transmitter Span</p>		Range : 0.000 ~ 9.999 Factory Default: SPn = 1.000 (Span : Difference between Upper Range (UPV) & Lower Range (LRV))
<p>7 Transmitter Offset</p>		Range : 0.000 ~ 9.999 Factory Default: oSt = 0.000 (Offset : Actual Output - Expected Output)

### Totalizer Reset

STEPS	DISPLAY	OPERATION
<p>1 Home Screen</p>		Home Screen
<p>2 Totalizer Reset</p>		Totalizer Value will Reset to Zero

# Truflo® — TKM Series In-Line Paddle Wheel Flow Meter Sensor

## Setting Output Limits (SSR\*)



Select/Save/Continue



Move Selection Left



Change Digit Value

STEPS	DISPLAY	OPERATION
<p>1 Home Screen</p>		
<p>2 Flow Rate Pulse Output (OP1)</p>		<p><b>Flow Rate Pulse Output (OP1) Limit</b>            CV ≥ SV : Flow Rate Output (OP1) ON            CV &lt; SV : Flow Rate Output (OP1) OFF</p>
<p>3 Totalizer Pulse Output (OP2)</p>		<p><b>Totalizer Pulse Output (OP2) Limit</b>            CV ≥ SV : Totalizer Output (OP2) ON            CV &lt; SV : Totalizer Output (OP2) OFF            Note: Refer <b>Totalizer Output (OP2) Control Settings</b> (Pg 8)</p>

\* SSR - Solid State Relay

## Wiring - SSR\* (For Totalizer) | Con n

Set "Con n" in **Totalizer Output (OP2) Control**  
(Refer Pulse Control Programming, Page 8)

Wire Color	Description
Brown	+10~30VDC
Black	Totalizer Pulse Output (OP2)
Blue	-VDC

## Wiring - SSR\* (For Flow Rate) | Con F/E/r/c

Set "Con F/E/r/c" in **Totalizer Output (OP2) Control**  
(Refer Pulse Control Programming, Page 8)

Wire Color	Description
Brown	+10~30VDC
White	Flow Rate Pulse Output (OP1)
Blue	-VDC

## Wiring - One Pulse/Gal | Con E

Set "Con E" in **Totalizer Output (OP2) Control**  
(Refer Pulse Control Programming, Page 8)

Wire Color	Description
Brown	+10~30VDC
Black	Totalizer Pulse Output (OP2)
Blue	-VDC

## Wiring - To Flow Display | Con F

Set "Con F" in **Totalizer Output (OP2) Control**  
(Refer Pulse Control Programming, Page 8)

Wire Color	Description
Brown	+10~30VDC
Black	Paddle Pulse
Blue	-VDC

\* SSR - Solid State Relay

# Truflo® — TKM Series

## In-Line Paddle Wheel Flow Meter Sensor

### Pulse Control Programming

**SET** Select/Save/Continue

**F** Move Selection Left

**▲ ▼** Change Digit Value

STEPS	DISPLAY	OPERATION
<b>1 Home Screen</b> 		Home Screen
<b>2 Totalizer Output (OP2) Control</b> 		Con = n : OP2 Manual Reset (When Totalizer = Set Value (SV)) Con = c   r : OP2 Auto Reset after (t 1) Secs Con = E : One Pulse/Gal (Default) Con = F : Paddle Pulse → Frequency Max 5 KHz (For TVF)
<b>3 OP2 Auto Reset Time Delay</b> 		Range: 0 ~ 999.99 Secs (Displayed only when <b>Con r   Con c</b> is selected)
<b>4 Relay Setting</b> 		Range: 0 ~ 3 Refer to <b>Relay Mode Selection</b>
<b>5 Hysterisis</b> 		Range: 0.1 ~ 999.9 (Hysterisis is a buffer around the Programmed Set Point)
<b>6 OPI Power On Time Delay</b> 		Range: 0 ~ 9999 Secs t2 = 20 Sec (Default)

### Relay Mode Selection

ALt No.	Description
<b>ALt = 0</b>	$CV \geq SV \rightarrow$ Relay ON   $CV < [SV - Hys] \rightarrow$ Relay OFF
<b>ALt = 1</b>	$CV \leq SV \rightarrow$ Relay ON   $CV > [SV + Hys] \rightarrow$ Relay OFF
<b>ALt = 2</b>	$[SV + Hys] \geq CV \geq [SV - Hys] \rightarrow$ Relay ON : $CV > [SV + Hys]$ or $CV < [SV - Hys] \rightarrow$ Relay OFF
<b>ALt = 3</b>	$[SV + Hys] \geq CV \geq [SV - Hys] \rightarrow$ Relay OFF: $CV > [SV + Hys]$ or $CV < [SV - Hys] \rightarrow$ Relay ON
Hys = Hysterisis — Acts like a buffer $\pm$ around (OPI) pulse output	
<b>CV: Current Value (Flow Rate)   SV = Set Value</b>	



# Truflor® — TKM Series

## In-Line Paddle Wheel Flow Meter Sensor

### Temperature | Pressure Graphs | Non-Shock

**Note:** The Pressure/Temperature graphs are specifically for the Truflor® Flow Meter Sensors.

During system design the specifications of all components must be considered.

### K-Factors for TK Series (V1)

Size	LPM	GPM
1/4"	547	2079
3/8"	300	1140
1/2"	127.6	484.9
3/4"	81.8	310.8
1"	55.1	209.4
1 1/2"	18.8	71.4
2"	10.2	38.8
3"	4.7	18
4"	2.1	8

⚠ K-Factor is Pre-Programmed

### K-Factors for TK Series (V2)

Size	K-Factor
1/2"	127.6
3/4"	81.8
1"	55.1
1 1/2"	18.8
2"	10.2
2 1/2"	6.0

■ = PVC ■ = PP ■ = PVDF

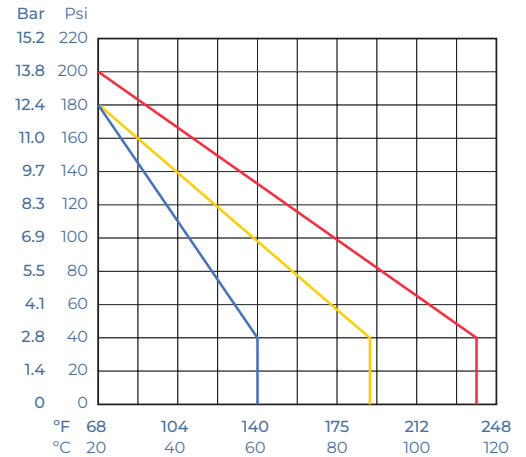

### Min/Max Flow Rates

Pipe Size (O.D.)	LPM   GPM		LPM   GPM		
	0.3m/s min.		10m/s max.		
DN08 (1/4")	0.6	0.16	12	3	◀ SS Only
DN10 (3/8")	1.8	0.48	50	13	◀ SS Only
DN15 (1/2")	3.5	1.0	120	32	
DN20 (3/4")	5.0	1.5	170	45	
DN25 (1")	9.0	2.5	300	79	
DN40 (1 1/2")	25.0	6.5	850	225	
DN50 (2")	40.0	10.5	1350	357	
DN65 (2 1/2")	60.0	16.0	1850	357	
DN80 (3")	90.0	24.0	2800	739	
DN100 (4")	125.0	33.0	4350	1149	

### Model Selection

PVC		
Size	End Connections	Part Number
1/2"	Sch 80 Soc	TKM-15-P
3/4"	Sch 80 Soc	TKM-20-P
1"	Sch 80 Soc	TKM-25-P
1 1/2"	Sch 80 Soc	TKM-40-P
2"	Sch 80 Soc	TKM-50-P
3"	Flanged	TKM-80-P
4"	Flanged	TKM-100-P

PVDF		
Size	End Connections	Part Number
1/2"	NPT	TKM-15-PF
3/4"	NPT	TKM-20-PF
1"	NPT	TKM-25-PF
1 1/2"	NPT	TKM-40-PF
2"	NPT	TKM-50-PF

**Note:** PVC Socket Ends (Std)  
PP/PVDF NPT Ends (Std)

PP		
Size	End Connections	Part Number
1/2"	NPT	TKM-15-PP
3/4"	NPT	TKM-20-PP
1"	NPT	TKM-25-PP
1 1/2"	NPT	TKM-40-PP
2"	NPT	TKM-50-PP
3"	Flanged	TKM-80-PP
4"	Flanged	TKM-100-PP

316 SS		
Size	End Connections	Part Number
1/4"	NPT	TK3M-08-SS
3/8"	NPT	TK3M-10-SS
1/2"	NPT	TK3M-15-SS
3/4"	NPT	TK3M-20-SS
1"	NPT	TK3M-25-SS
1 1/2"	NPT	TK3M-40-SS
2"	NPT	TK3M-50-SS
3"	NPT	TK3M-80-SS
4"	NPT	TK3M-100-SS

#### Add 2<sup>nd</sup> Suffix (seals):

- FKM (std, no suffix required)
- E ▶ EPDM Seals
- K ▶ FFKM | Kalrez® Seals

#### Add 1<sup>st</sup> Suffix (end connection):

- T ▶ NPT End Connectors (on PVC)
- B ▶ Butt Fusion End Connections for PP or PVDF
- F ▶ Flange ANSI 150lb - Consult Factory

# Truflo® — TKM Series In-Line Paddle Wheel Flow Meter Sensor

## Dimensions

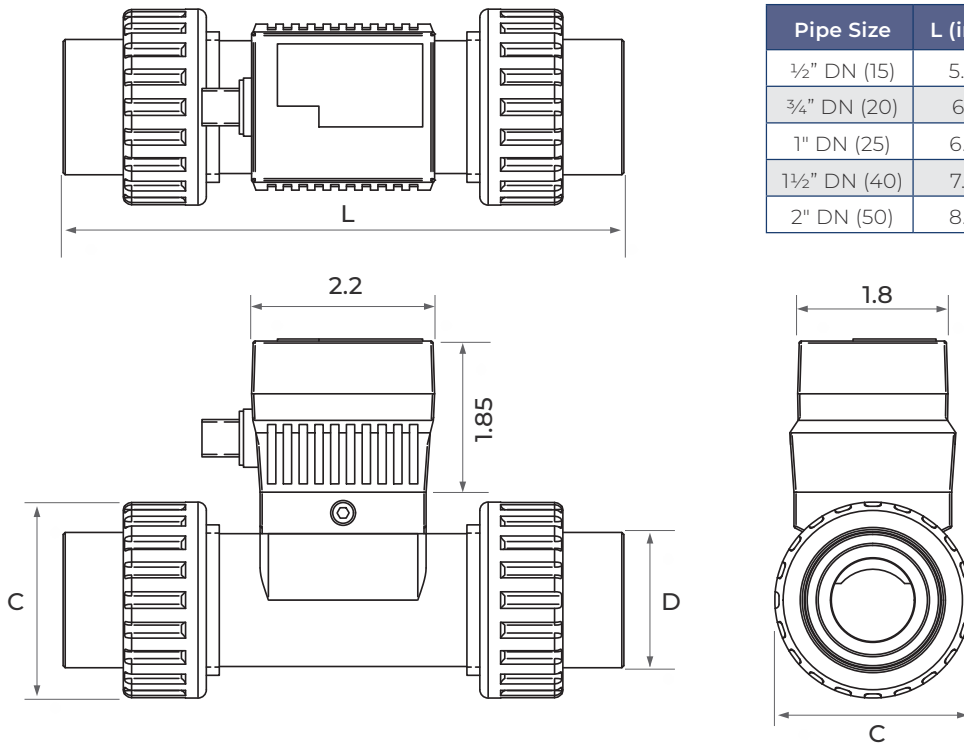

Pipe Size	L (inch)	D (inch)	C (inch)
½" DN (15)	5.48	1.07	1.61
¾" DN (20)	6.12	1.36	2.08
1" DN (25)	6.76	1.68	2.36
1½" DN (40)	7.66	2.33	3.26
2" DN (50)	8.40	2.86	4.33

## Procedure to Rotate Display

- Using an allen key loosen the 2 screws located on either side of the display.
- Pull the Screws | Do Not Remove!
- Lift the Display.
- Rotate Display - 90 Degrees
- Lower Display.
- ⚠ Tighten Allen Screws | Snug Tight Do Not Over-Tighten!

# Truflo® — TKM Series

## In-Line Paddle Wheel Flow Meter Sensor

### Installation Position

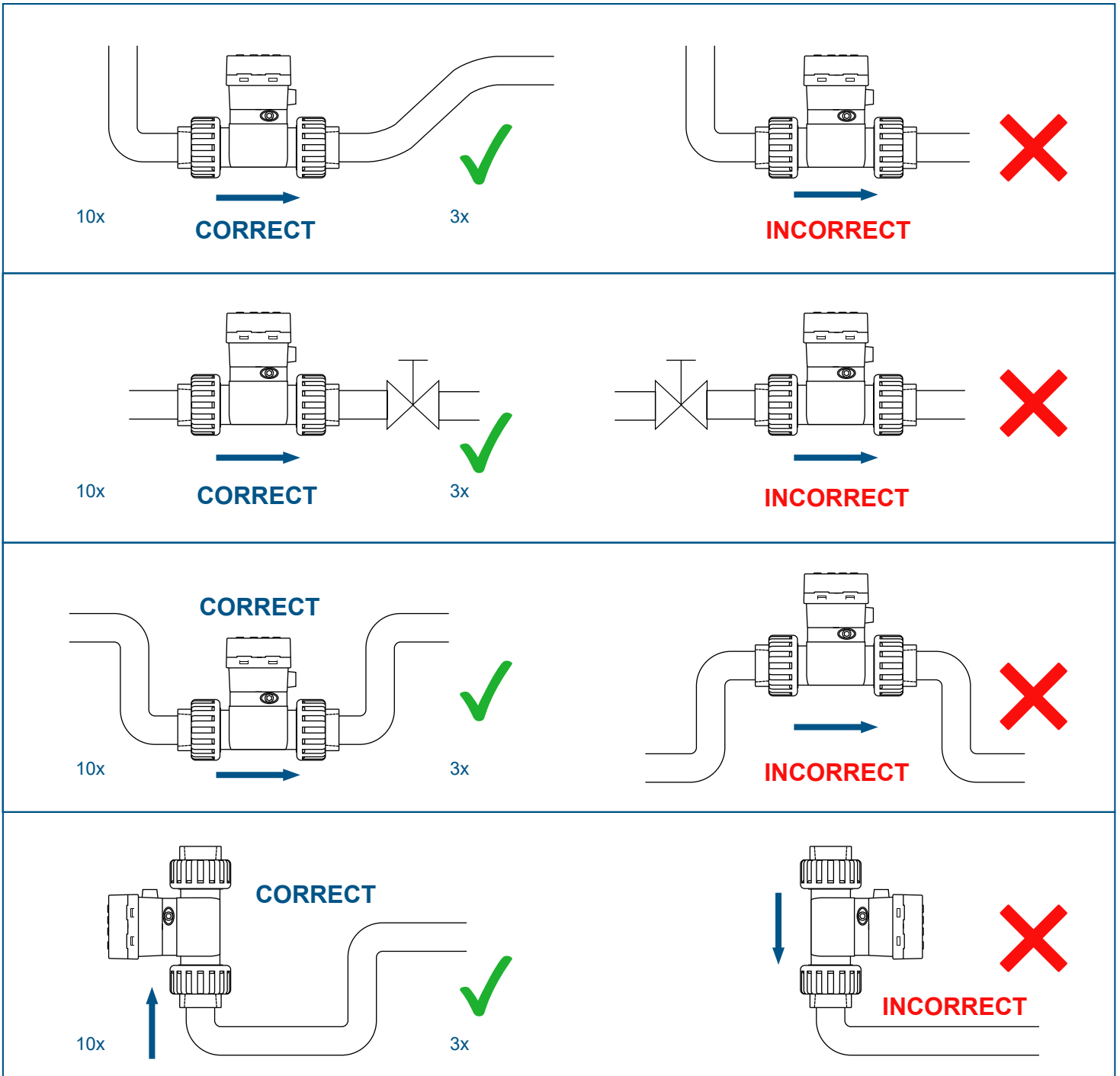

#### Please Ensure Full Pipe

TK Series can be installed in a horizontal or vertical direction. Please ensure enough length of straight pipe to avoid turbulence that can effect readings.

#### Note: Min 10x Pipe Diameters Upstream 3x Pipe Diameters Downstream.

A Plastic Basket Strainer, Bag Filter or Y Strainer Filtering Device upstream to Avoid the Paddle Wheel from being damaged by the solids or fibers - max 10% Particle Size - Not to Exceed .5mm Cross Section or Length. Please do not flush the pipe after the Flow Meter is installed with Compressed Air this may damage the ceramic shaft and will Void Warranty.

## Warranty, Returns and Limitations

### Warranty

Icon Process Controls Ltd warrants to the original purchaser of its products that such products will be free from defects in material and workmanship under normal use and service in accordance with instructions furnished by Icon Process Controls Ltd for a period of one year from the date of sale of such products. Icon Process Controls Ltd obligation under this warranty is solely and exclusively limited to the repair or replacement, at Icon Process Controls Ltd option, of the products or components, which Icon Process Controls Ltd examination determines to its satisfaction to be defective in material or workmanship within the warranty period. Icon Process Controls Ltd must be notified pursuant to the instructions below of any claim under this warranty within thirty (30) days of any claimed lack of conformity of the product. Any product repaired under this warranty will be warranted only for the remainder of the original warranty period. Any product provided as a replacement under this warranty will be warranted for the one year from the date of replacement.

### Returns

Products cannot be returned to Icon Process Controls Ltd without prior authorization. To return a product that is thought to be defective, and submit a customer return (MRA) request form and follow the instructions therein. All warranty and non-warranty product returns to Icon Process Controls Ltd must be shipped prepaid and insured. Icon Process Controls Ltd will not be responsible for any products lost or damaged in shipment.

### Limitations

This warranty does not apply to products which:

1. are beyond the warranty period or are products for which the original purchaser does not follow the warranty procedures outlined above;
2. have been subjected to electrical, mechanical or chemical damage due to improper, accidental or negligent use;
3. have been modified or altered;
4. anyone other than service personnel authorized by Icon Process Controls Ltd have attempted to repair;
5. have been involved in accidents or natural disasters; or
6. are damaged during return shipment to Icon Process Controls Ltd

Icon Process Controls Ltd reserves the right to unilaterally waive this warranty and dispose of any product returned to Icon Process Controls Ltd where:

1. there is evidence of a potentially hazardous material present with the product;
2. or the product has remained unclaimed at Icon Process Controls Ltd for more than 30 days after Icon Process Controls Ltd has dutifully requested disposition.

This warranty contains the sole express warranty made by Icon Process Controls Ltd in connection with its products. ALL IMPLIED WARRANTIES, INCLUDING WITHOUT LIMITATION, THE WARRANTIES OF MERCHANTABILITY AND FITNESS FOR A PARTICULAR PURPOSE, ARE EXPRESSLY DISCLAIMED. The remedies of repair or replacement as stated above are the exclusive remedies for the breach of this warranty. IN NO EVENT SHALL Icon Process Controls Ltd BE LIABLE FOR ANY INCIDENTAL OR CONSEQUENTIAL DAMAGES OF ANY KIND INCLUDING PERSONAL OR REAL PROPERTY OR FOR INJURY TO ANY PERSON. THIS WARRANTY CONSTITUTES THE FINAL, COMPLETE AND EXCLUSIVE STATEMENT OF WARRANTY TERMS AND NO PERSON IS AUTHORIZED TO MAKE ANY OTHER WARRANTIES OR REPRESENTATIONS ON BEHALF OF Icon Process Controls Ltd. This warranty will be interpreted pursuant to the laws of the province of Ontario, Canada.

If any portion of this warranty is held to be invalid or unenforceable for any reason, such finding will not invalidate any other provision of this warranty.

For additional product documentation and technical support visit:



by



Corrosion-Free  
Instrumentation Equipment