

TECHNICAL SPECIFICATIONS

Supply Characteristics :	
Supply Voltage	12 - 240 VAC / DC
Supply Variation	-15% to +10% of \varnothing
Frequency	50-60 Hz, (\pm 3 Hz)
Power Consumption (Typical)	6 VA
Signal Characteristics :	
Signal sensing time	60 ms (For both High and Low Signal Detection)
Signal Impedance	>6K@10VAC/DC; >70K@110VAC/DC; >150K@240VAC/DC
Signal switch current requirement	Switching capacity of the switch or contact should be >10mA
Relay O/P Characteristics :	
Contact Arrangement	2 C/O Potential free contacts
Contact Rating (Resistive Load)	8A (Res.) @240V AC, 5A at 24 VDC
Contact Material	AgNi
Electrical Life	50,000 Operations min.
Mechanical Life	10,000,000 Operations min.
Feature Characteristics :	
Set Time (Ts)	0.1 seconds to 100 hrs
Setting Accuracy	+/- 5% of full scale
Repeat Accuracy	+/- 1%
Mode Adjustment	Refer 'Timing diagrams of Functions'
Range Adjustment (T)	1s-10s; 10s-1m; 1m-10m; 10m-1h; 1h-10h; 10h-100h **
Multiplier Adjustment (t)	0.1-0.3; 0.3-0.5; 0.5-0.7; 0.7-0.9; 0.9-1 **
LED Indication on front panel	Green LED ON = Power ON; Green LED FLASH = Timing in progress (100 msec ON/OFF); Yellow LED ON = Relay ON
Mounting	Din-Rail
Dimensions (W x H x D)	18 x 90 x 66 (in mm)
Weight (Unpacked)	72 g
Humidity	95% Rh Non Condensing
Operating Temperature	-20°C to +60°C
Storage Temperature	-25°C to +70°C
Max. Operating Altitude	2000m
Housing	Flame retardant (UL 94-V0)
Degree and Protection	IP-20 for Terminal; IP-40 for Housing
Pollution Degree	II
Isolation (I/P and O/P)	2KV
Isolation (Terminal and Casing)	2.5KV
Type of Insulation	Reinforced
Certifications	CE, ROHS
Initiate Time	Max. 100ms
Reset Time	Max. 200ms
EMI / EMC:	
Harmonic Current Emissions	IEC 61000-3-2 Class A
ESD	IEC 61000-4-2 Air Discharge-Level III, Contact Discharge-Level II
Radiated Susceptibility	IEC 61000-4-3 Level III
Electrical Fast Transient	IEC 61000-4-4 Level IV
Surge	IEC 61000-4-5 Level III
Conduct Susceptibility	IEC 61000-4-6 Level III
Voltage Dips and Interruptions (AC)	Level as per IEC 61812-1
Voltage Dips and Interruptions (DC)	Level as per IEC 61812-1
Conducted Emission	CISPR 11 Class B
Radiate Emission	CISPR 11 Class B

** Timing(Ts) can be updated during run time, by changing Range (T) and Multiplier (t) values.



TS09 ELECTRONIC TIMER Multi-Function 2 C/O



RoHS





039349-01 1.1 06/2025

Caution:

1. Always follow instructions stated in this product leaflet.
2. Before installation, check that the specifications agree with the intended application.
3. Installation to be done by skilled electrician.
4. Automation and Control devices must be properly installed so that they are protected against any risk of involuntary actuations.
5. Suitable dampers should be provided in case of excessive vibrations.
6. Use of 250 mA fuse in series with product supply is recommended.
7. The timers shall be placed in an enclosure that is minimum 200% of the size of the timer in the end use application.
8. Setting of all the potentiometers should be in clockwise direction only.

Terminal Details:

 Ø3.5...3.8 mm	0.4 N.m (3.6 Lb.in)
	1 x 2.5 mm ² Solid / Stranded Wire
AWG	1 x 24 to 12

Use Cu wire of 75°C only.

AWG	Sq. mm.	Max. Current (A)
12	2.5	16*
14	2.0	15
16	1.5	10
18	1.0	7
20	0.75	5
22	0.5	3
24	0.2	2

*This maximum rating has been decided on the basis of maximum current capacity of the product.
Note: Maximum current values are mentioned for resistive load.

TS09 Timer is manufactured to a high degree of precision and accuracy. The time settings are stepless and can be set with the knob.

FUNCTION DIAGRAM:

stn) Signal on Delay:

Timing starts when Switch (S) is closed. R energizes at end of period Ts and de-energizes when Switch (S) is opened.

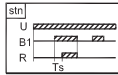

cnf) Cyclic On/Off: On Start

Initially, the relay (R) is On for period Ts after the power is applied. The relay (R) keeps on changing its status till power is removed with On and Off period = Ts.

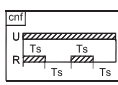

cnf) Cyclic Off/On: Off start

Initially, the relay (R) is Off for period Ts after the power is applied. The relay (R) keeps on changing its status till power is removed with On and Off period = Ts.

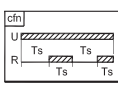

sf) OFF Delay, Constant Supply (Signal Off Delay)

R energizes when Switch (S) is closed. Timing commences after Switch (S) is opened and then the relay de-energizes.

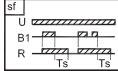

sfn) Signal Off/On

When Switch (S) is closed or opened for preset time Ts, the relay changes its state after time duration Ts.

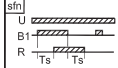

san) Accumulative Delay On Signal

Time commences as supply is present and Switch (S) is open. Closing Switch (S) pauses timing. Timing resumes when Switch (S) opened again R energizes at the end of timing.

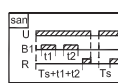

inf) Impulse On/Off

R energizes for the period Ts when Switch (S) is opened or closed. When timing commences, changing state of Switch (S) does not affect R but resets timer.

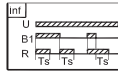

il) ON Impulse, Constant Supply

When switch (S) is closed and remains closed output relay energizes until timing is over. If Switch (S) is Opened during period Ts, R resets.

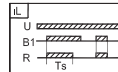

it) OFF Impulse, Constant Supply

When Switch (S) is opened, R energizes and de-energizes when timing is over. If Switch (S) is closed during period Ts R resets

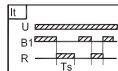

sbj) Leading Edge Bi-stable or Step relay

After every Signal, the output contact changes state, alternately switching from open to closed & vice versa.

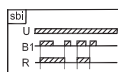

DERIVED MODES

1) ON Delay

- Select mode signal On Delay (stn) and close Switch (S) or short A1-B1 before power ON, it will work as ON Delay.
- Select mode Accumulative On Delay (san) keeping signal open before power ON and during execution of time as well, it will work as ON Delay.

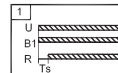

2) INTERVAL

Select mode (il) ON Impulse. If Switch (S) is closed between A1-B1 before making power supply ON and during execution of timing, it will work as Interval.

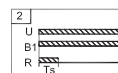

Dimensions

Overall product dimensions and mounting details:

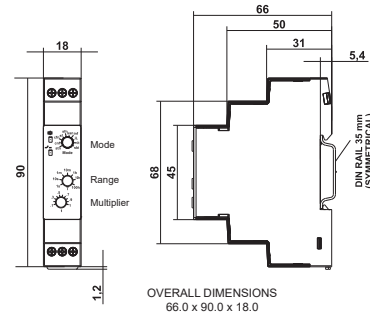

Wiring Diagram

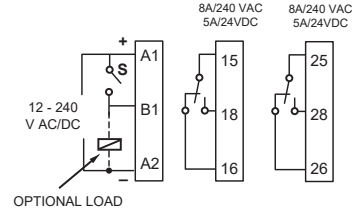

Installation

DIN-Rail Mounting:

The Timer should be mounted on 35 mm symmetrical DIN Rail.

Sensor Connection Diagram

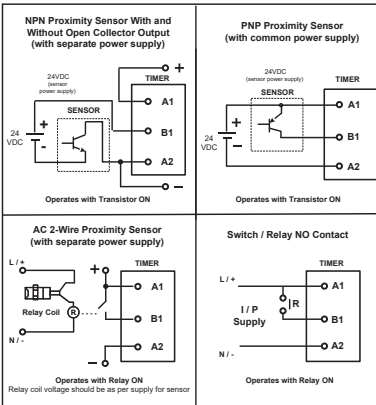

NOTE

Product innovation being a continuous process, we reserve the right to alter specifications without any prior notice.

Product Standard	IEC 61812-1	
Safety		
Test Voltage between I/P and O/P	IEC 60947-5-1/UL 508	2KV
Test Voltage between all terminals and enclosure	IEC 60947-5-1/UL 508	2.5KV
Impulse voltage between I/P and O/P	IEC 60947-5-1	4KV
Single Fault	IEC 61010-1	
Insulation Resistance	UL508	>50k Ω
Leakage Current	UL508	< 3.5 mA
Environmental		
Cold Heat	IEC 60068-2-1	
Dry Heat	IEC 60068-2-2	

E-Waste Regulatory notice:

Kindly treat, recycle or dispose of this equipment in an environmentally sound manner after End of Life, as per WEEE (Waste Electrical and Electronic Equipment) regulations or as per local norms.